

Protected by copyright. Copying for private or commercial purposes in part or in full is not permitted unless authorised by AUDI AG. AUDI AG does not guarantee or accept any liability with respect to the correctness of information in this document. Copyright by AUDI AG.

# Tyre Pressure Monitoring System

## Design and Function

### Self-Study Programme 219

## The tyre pressure check system

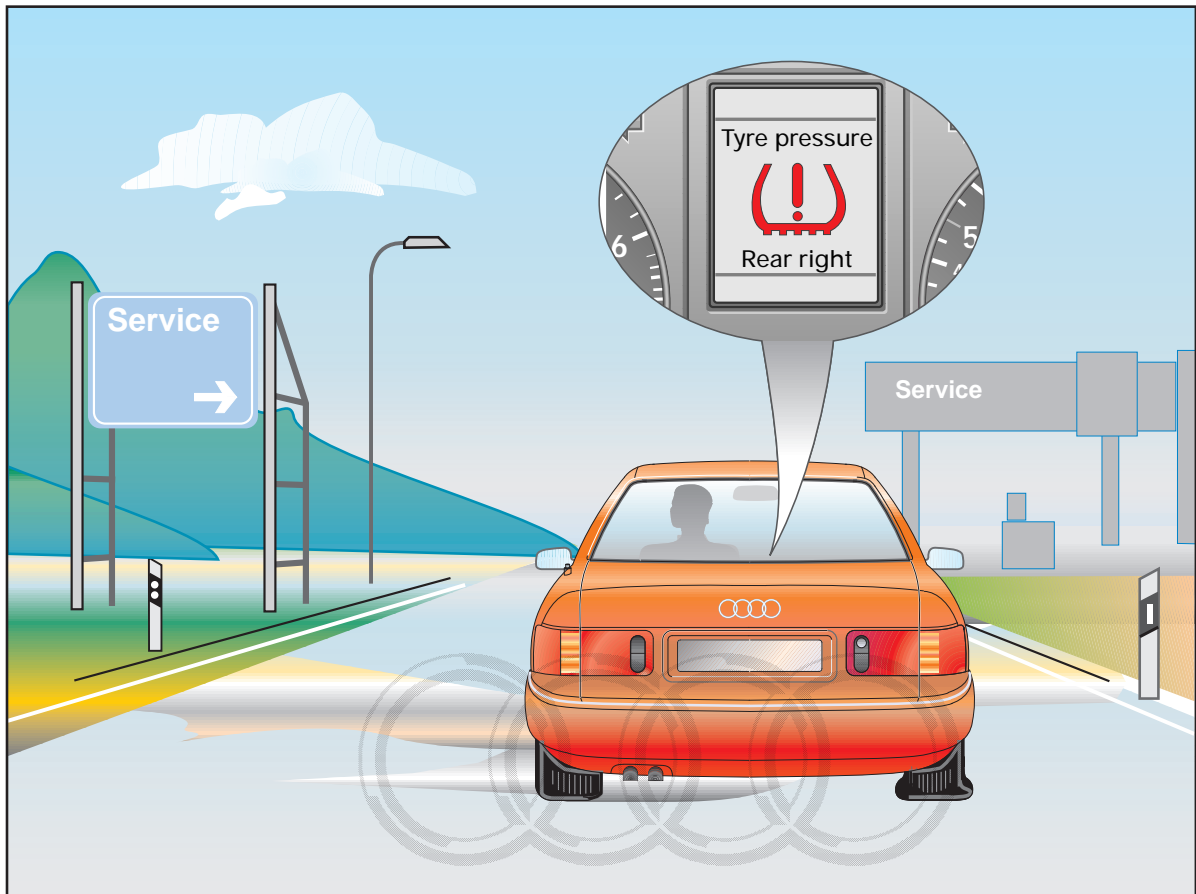

SSP219\_002

.... a new step forward in terms of safety and convenience!

Protected by copyright. Copying for private or commercial purposes, in part or in whole, is not permitted unless authorised by AUDI AG. AUDI AG does not guarantee or accept any liability with respect to the correctness of information in this document. Copyright by AUDI AG.



The tyre pressure check system makes it possible to monitor the tyre pressure when the vehicle is stationary and while travelling.



The driver is still responsible for ensuring the tyre pressure matches the manufacturer's specifications.

This Self-Study Programme gives you information regarding the design and function of the tyre pressure check system used by Audi.

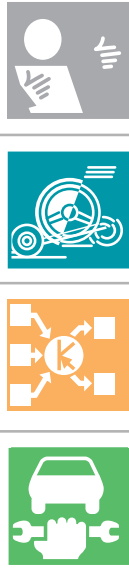

	Page
<b>Introduction</b>	
General description .....	4
<b>System components</b>	
Vehicle overview .....	7
System overview/Function diagram .....	8
Metal valve .....	10
Tyre pressure sensor .....	11
Antenna for tyre pressure monitoring .....	16
Control unit for tyre pressure monitoring .....	18
<b>System functions</b>	
Operation .....	20
Messages .....	21
Own wheel recognition .....	31
Position recognition .....	32
Spare wheel .....	33
Convenience CAN interface .....	34
<b>Service</b>	
Self-diagnosis .....	35

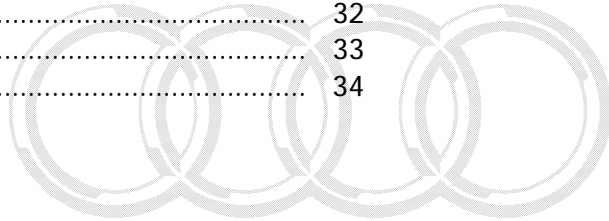

# Audi

Protected by copyright. Copying for private or commercial purposes, in part or in whole, is not permitted unless authorised by AUDI AG. AUDI AG does not guarantee or accept any liability with respect to the correctness of information in this document. Copyright by AUDI AG.



The Self-Study Programme informs you about designs and functions.

The Self-Study Programme is not a Workshop Manual!

Please refer to the the relevant technical literature for all maintenance and repair instructions.

New!



Important!  
Note!



# Introduction



## General description

Tyre defects are, according to statistical data, a common cause of accident and breakdown. In the majority of cases, low tyre pressure is the reason for failure as a result of tyre damage (low tyre pressure is responsible for 85 % of blowouts).

Although the correct tyre pressure is important for driving safety, durability of the tyres and fuel consumption, tyre pressure is one of the few variables which to date has not been the subject of continuous monitoring.

The driver has no information on momentary air pressure while travelling.

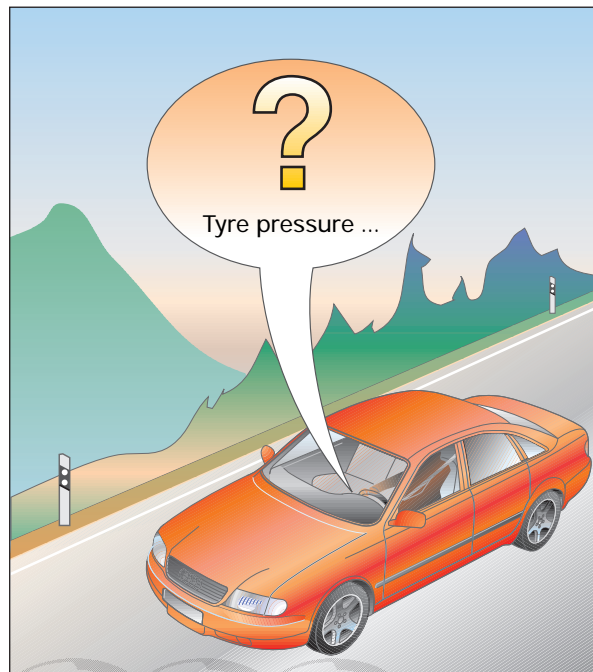

SSP219\_003

The advancements in the miniaturisation of electronics as well as the increase in the capacity of batteries made it possible to develop a dynamic tyre pressure monitoring system.

The tyre pressure check system continuously monitors the tyre pressure while travelling and when the vehicle is stationary.

This system assists the driver in two ways: firstly it monitors the set tyre pressures and, secondly, it alerts the driver to loss of pressure by issuing warnings via the instrument cluster.

The tyre pressure check system will be used for the first time in the AUDI A8/S8 of model year 2000.

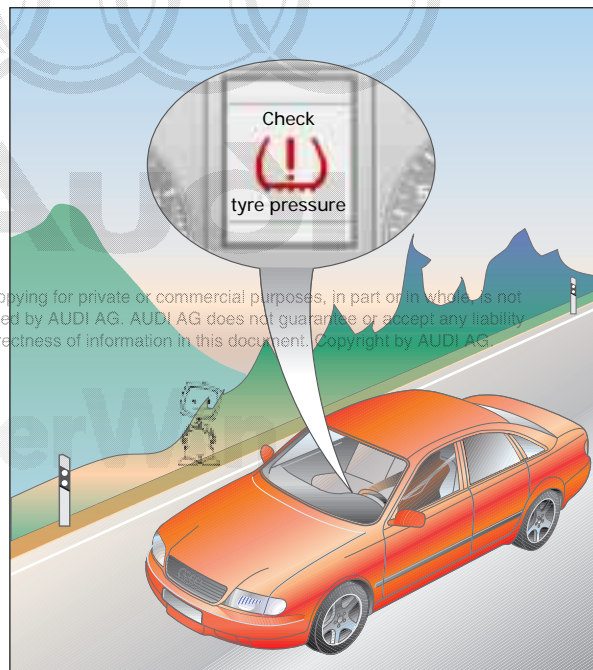

SSP219\_004



## The tyre pressure check system

The tyre pressure check system used by Audi is a 4-wheel system. Although the spare wheel is monitored and "managed" by the control unit, it is excluded from the system status messages (for further details, refer to "spare wheel").

Data transfer from the wheel sensors to the control unit is effected by means of radio-frequency (RF) transmission. Information exchange between the peripheral components in the vehicle takes place via the convenience CAN-Bus.

A measuring and transmitter unit mounted on the tyre valve sends a radio signal at regular time intervals to the antennas for tyre pressure monitoring integrated in the wheel housing. This signal is then relayed to the control unit for tyre pressure monitoring.

The control unit for tyre pressure monitoring evaluates the tyre pressures and/or the pressure change and sends corresponding system status messages to the instrument cluster. These messages are indicated to the driver on the display of the Driver Information System (FIS).

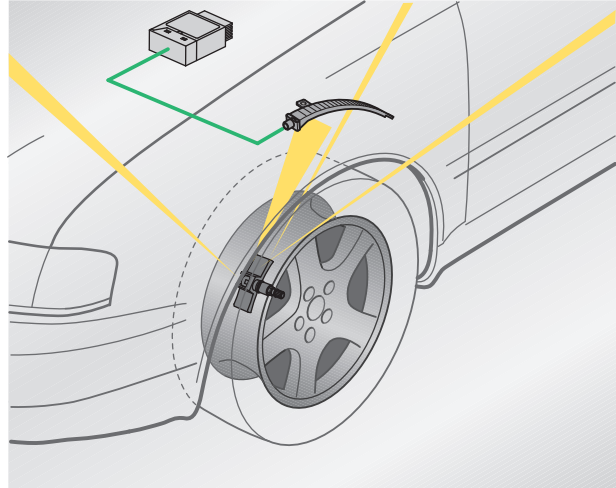

SSP219\_012



The tyre pressure check system offers the following advantages:

– More safety through early "low tyre pressure" warnings

– More convenience through the elimination of regular tyre pressure checks. The tyre pressure need only be corrected when this is indicated

– Longer service life of tyres (a pressure deficit of 0.3 bar can reduce the service life of tyres by up to 25 %)

– Lower fuel consumption through correct tyre pressure

Protected by copyright. Copying for private or commercial purposes, in part or in whole, is not permitted unless authorised by AUDI AG. AUDI AG does not guarantee or accept any liability with respect to the content of this document. © 2014 AUDI AG.

# Introduction



## Tyre pressure monitoring

It differentiates between the following situations:

... slow loss of pressure

A slow loss of pressure is indicated to the driver at an early stage so the driver can check the tyres or correct the tyre pressure.

... sudden loss of pressure

If a sudden loss of pressure occurs (blowout, flat tyre) while travelling, the driver is alerted immediately.

... flat tyre when the vehicle is stationary

The system indicates a flat tyre when the vehicle is stationary to the driver directly after turning on the ignition.

85 % of "blowouts" are the result of a slow loss of pressure. This is triggered by overheating as a result of flexing work when driving at high speed with insufficient air pressure.

The driver will normally notice this anyway by the way the vehicle reacts. In vehicles with an emergency running system, there is the danger of the driver not noticing a flat tyre immediately because the system runs so smoothly. In this case, the tyre pressure check system is the only safe way of alerting the driver to the safety risk.

Wheels with an emergency running system allow one to continue driving without tyre pressure, however cornering stability is impaired. Therefore, driving safety is also compromised.

Furthermore, speed and distance restrictions must be observed in order to preserve the wheel's emergency running characteristics and to protect the tyres from irreparable damage.

The tyre pressure check system indicates the loss of pressure to the driver at an early stage so that he can take appropriate action.

Protected by copyright. Copying for private or commercial purposes, in part or in whole, is not permitted unless authorized by the copyright holder. The copyright holder is responsible for the content of the text with respect to the accuracy of the information provided. Copyright © 2014 VDA AG.



# System components

## Vehicle overview

The tyre pressure check system comprises the following components:

- 5 tyre pressure sensors
- 4 antennas for tyre pressure monitoring
- Control unit for tyre pressure monitoring
- Instrument cluster
- Function selector switch

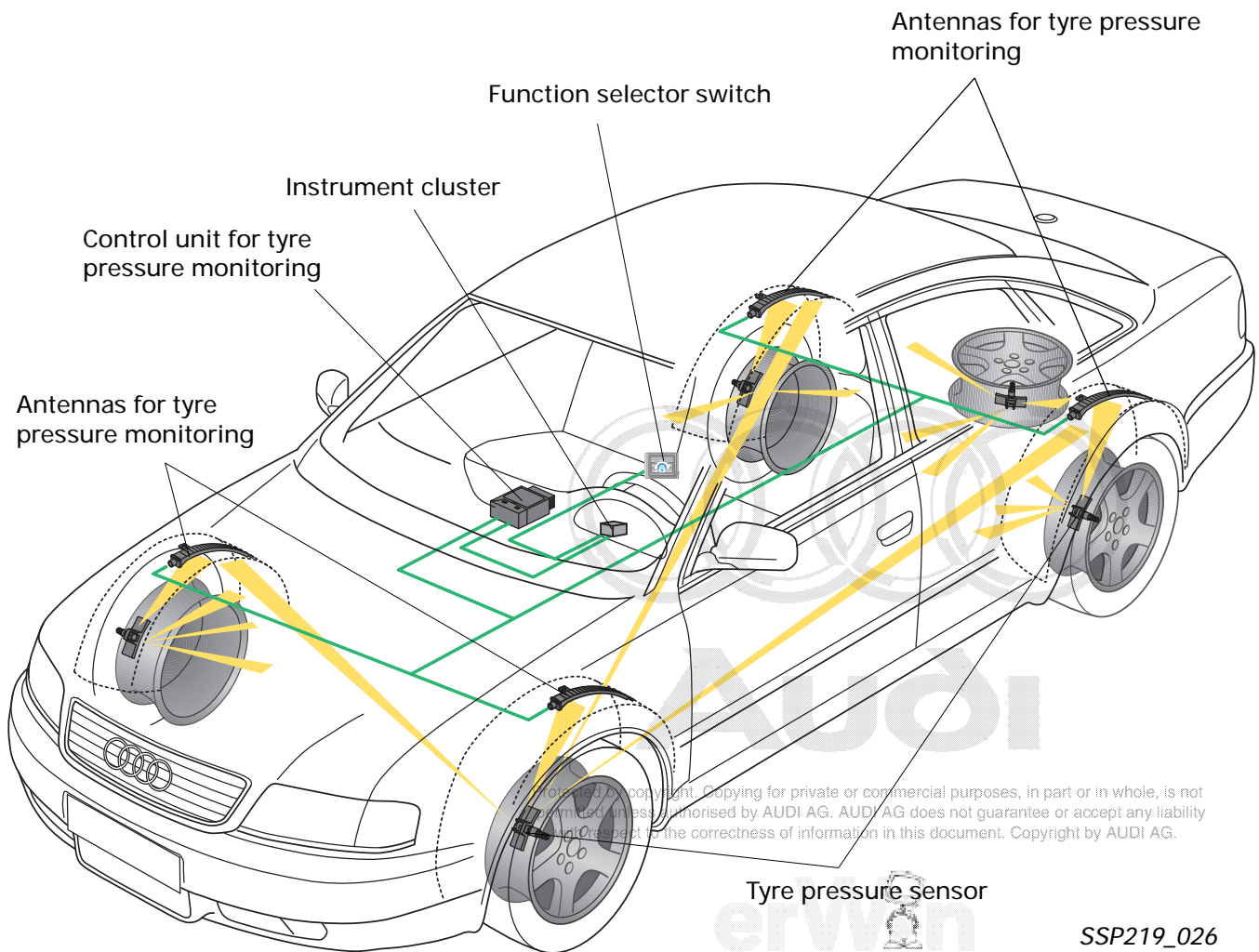

# System components

## System overview/function diagram

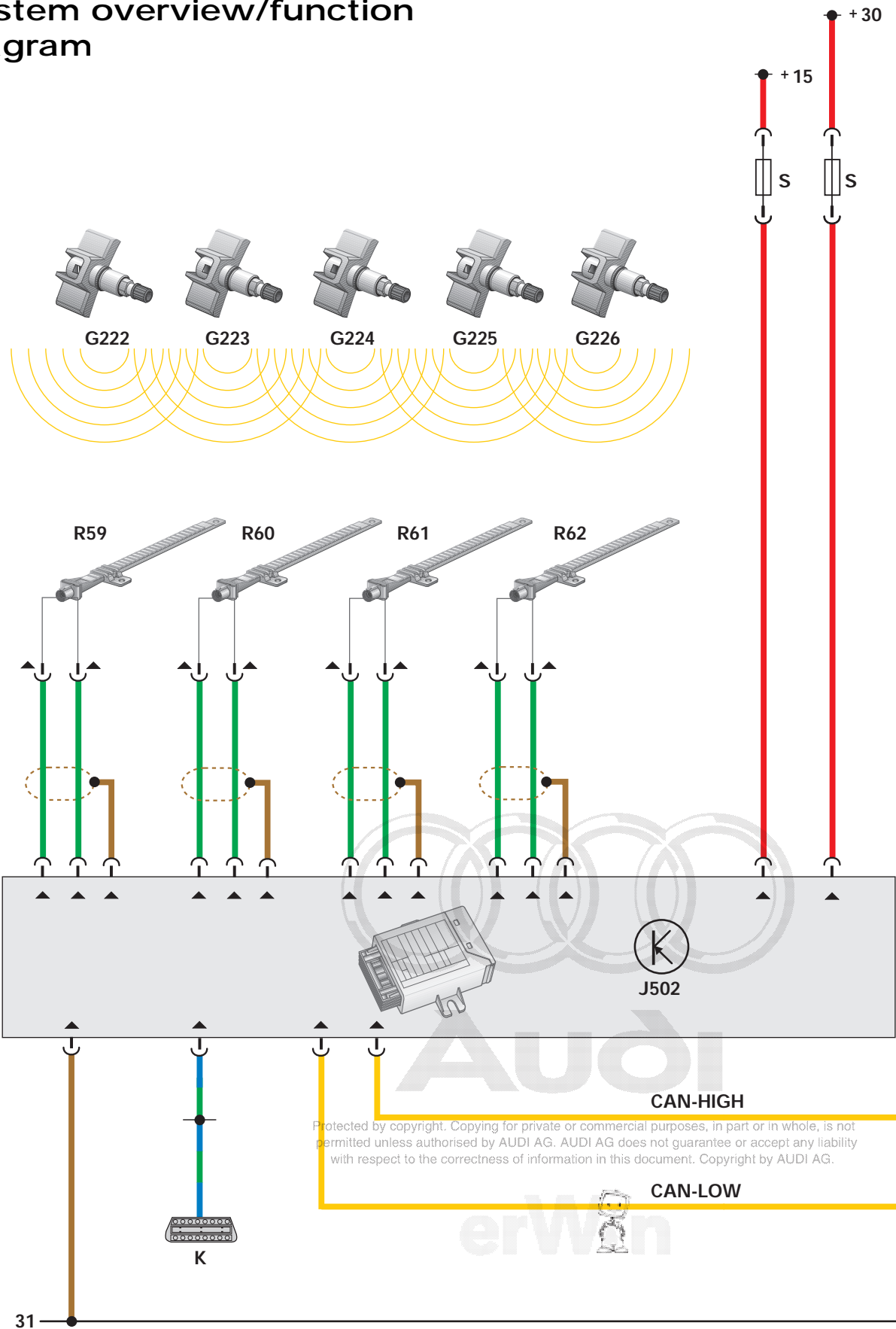

Protected by copyright. Copying for private or commercial purposes, in part or in whole, is not permitted unless authorised by AUDI AG. AUDI AG does not guarantee or accept any liability with respect to the correctness of information in this document. Copyright by AUDI AG.



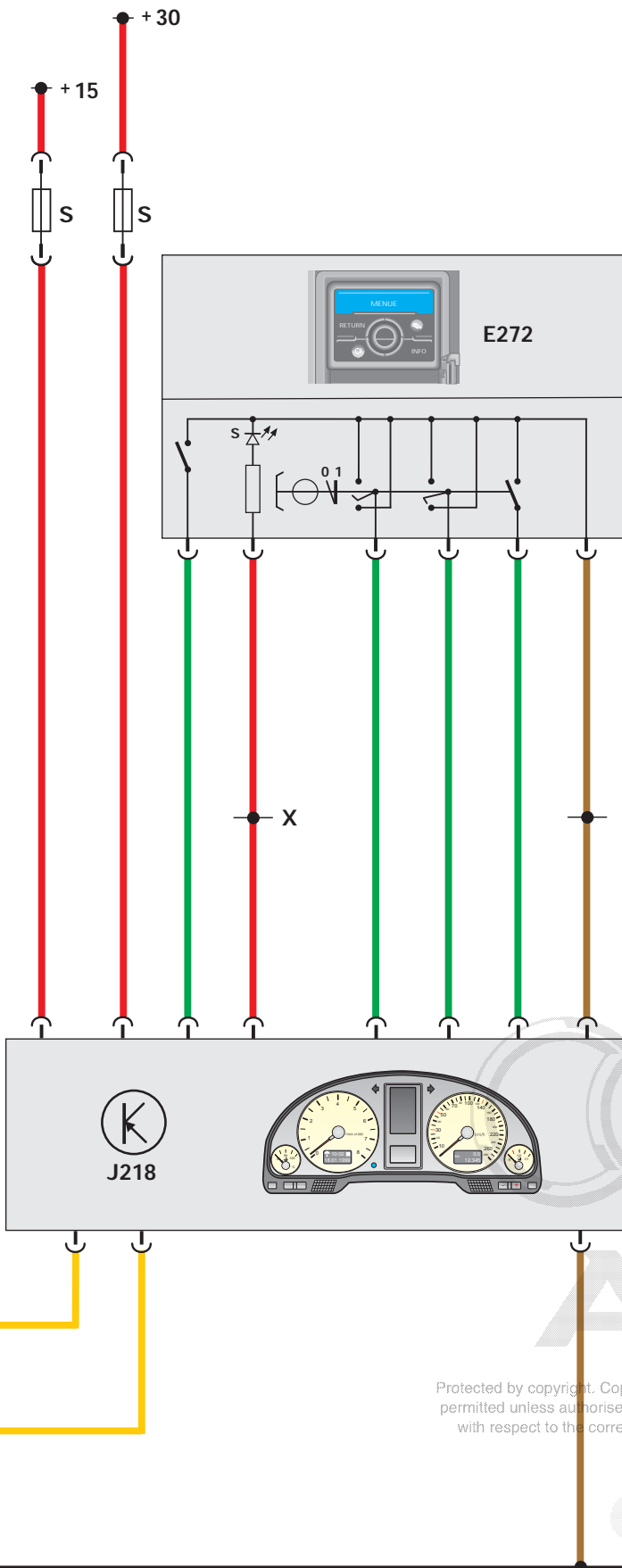

### Components

- E272 Function selector switch
- G222 Front left tyre pressure sensor
- G223 Front right tyre pressure sensor
- G224 Rear left tyre pressure sensor
- G225 Rear right tyre pressure sensor
- G226 Spare wheel tyre pressure sensor
- J218 Combination processor in the dash panel
- J502 Control unit for tyre pressure monitoring
- K Diagnostic connection
- R59 Antenna for tyre pressure monitoring, front left
- R60 Antenna for tyre pressure monitoring, front right
- R61 Antenna for tyre pressure monitoring, rear left
- R62 Antenna for tyre pressure monitoring, rear right
- X Terminal 58s

▲ Gold contact

### Colour codes

- = input signal
- = output signal
- = positive
- = earth
- = convenience CAN-bus

Protected by copyright. Copying for private or commercial purposes, in part or in whole, is not permitted unless authorised by AUDI AG. AUDI AG does not guarantee or accept any liability with respect to the correctness of information in this document. Copyright by AUDI AG

# System components

## Metal valve

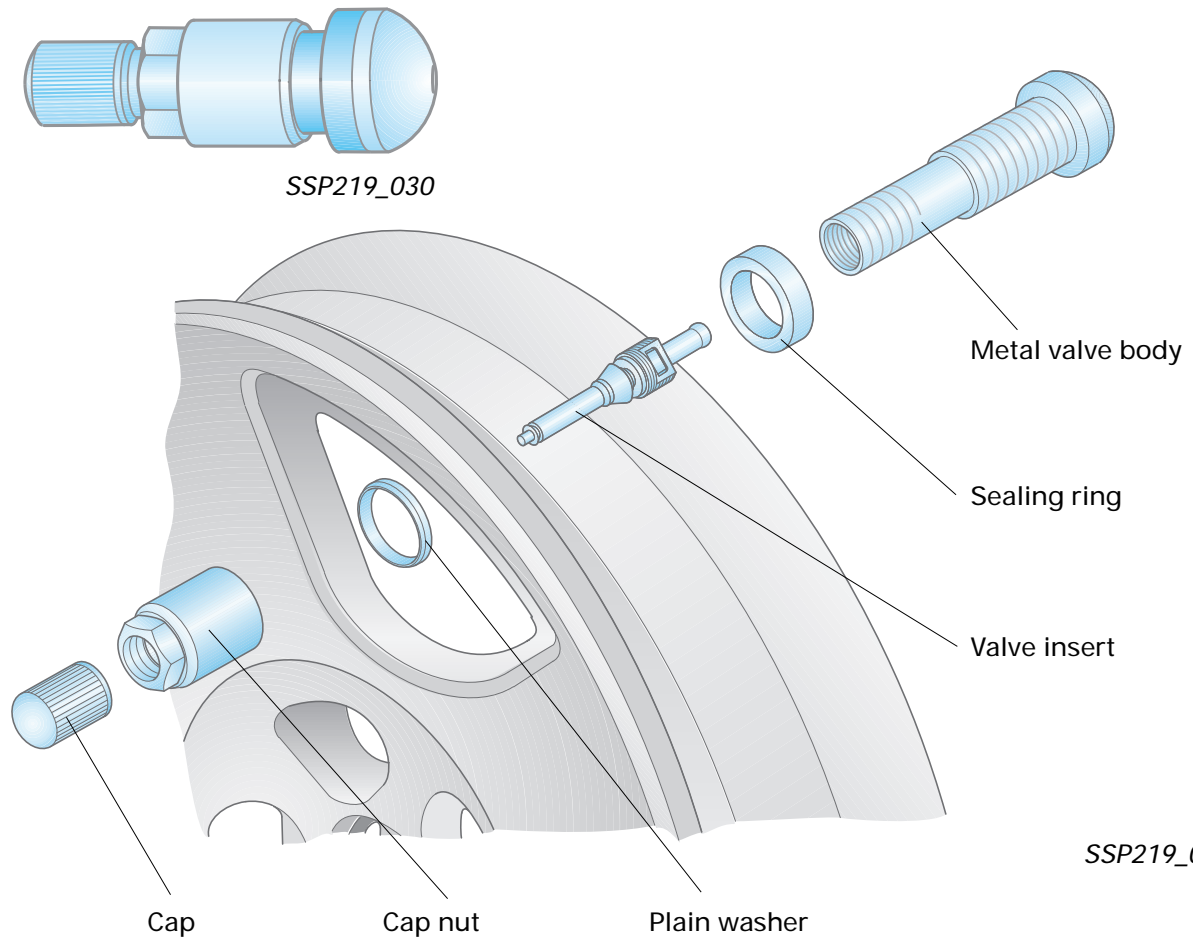

The tyre inflating valve was redesigned for the tyre pressure check system. A metal valve is now used in place of the rubber valve used previously.



When performing a tyre change (new tyre –old rim), only the valve insert need be renewed (refer to Workshop Manual).

Protected by copyright. Copying for private or commercial purposes, in part or in whole, is not permitted unless authorised by AUDI AG. AUDI AG does not guarantee or accept any liability with respect to the correctness of information in this document. Copyright by AUDI AG.



## Tyre pressure sensor G222 ... G226

The tyre pressure sensor is attached to the metal valve by screws and can be reused after changing the wheel or rim.

The following components are integrated in the tyre pressure sensor:

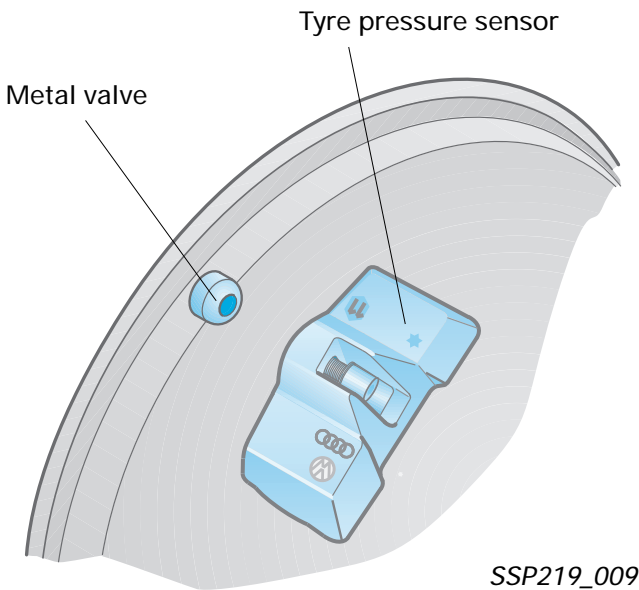

The pressure sensor records the momentary tyre pressure (absolute pressure measurement) and sends the measured data to the control unit for tyre pressure monitoring for evaluation purposes.

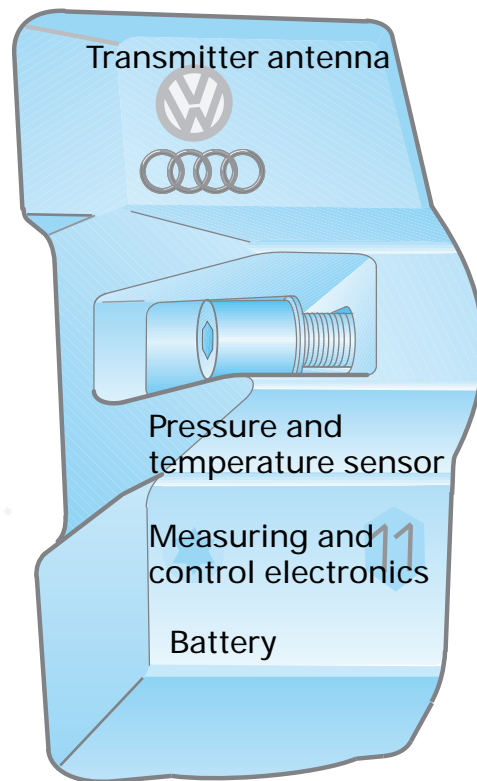

The temperature signal is used, firstly, to compensate for the temperature-dependent changes in tyre pressure and, secondly, for diagnostic purposes.

If a defined temperature threshold is exceeded, the sensor stops radio transmission (for further details, refer to "Temperature cut-off").

The pressure sensor, the temperature sensor and the measuring and control electronics are integrated as an intelligent sensor.

Temperature compensation is effected in the control unit for tyre pressure monitoring. The measured tyre pressures are normalised to a temperature of 20 °C.

Protected by copyright. Copying for private or commercial purposes, in part or in whole, is not permitted unless authorized by AUDI AG. AUDI AG does not guarantee or accept any liability for the information in this document. Copyright by AUDI AG.



# System components

Depending upon import version, two different carrier frequencies are used for radio transmission.

The carrier frequency of 433 MHz is permitted in most countries.

A carrier frequency of 315 MHz used in a few countries (e.g. USA).

The carrier frequency is printed on the sensors, antennas and control units. It can also be identified by the part No.

The tyre pressure check system only works with system components with the same carrier frequency.

The air pressure in a closed system changes in proportion to temperature.

In normal circumstances, a temperature change of 10°C results in a pressure change of 0.1 bar.



Enter "Save pressures", and the tyre pressures are normalised to 20°C.

To avoid faulty settings, special care must be taken to ensure that the tyre pressures are checked and/or corrected and stored when the tyres are cold.

## Explanatory notes:

"Atmospheric pressure" is the term which is used to describe the air pressure at the earth's surface. With reference to mean sea level, this pressure is, on average, 1013 mbar.

We generally refer to this as 1 bar.

The relative pressure indicates the pressure, using atmospheric pressure as the starting point.

The absolute pressure is the pressure using zero pressure as the starting point.

Protected by copyright. Copying for private or commercial purposes, in part or in whole, is not permitted unless authorized by Audi AG. Audi AG does not warrant the accuracy of any data with respect to the correctness of information in this document. Copyright by AUDI AG.





The transmitter antenna of the tyre pressure sensor sends the following information:

- individual ID number (ID code)
- momentary tyre pressure (absolute pressure)
- momentary tyre air temperature
- condition of integrated battery
- as well as status, synchronisation and control information required for safe data transfer

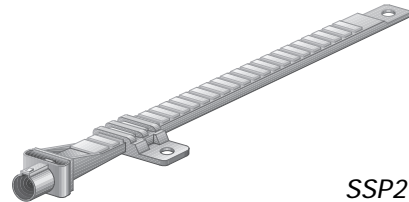

SSP219\_011

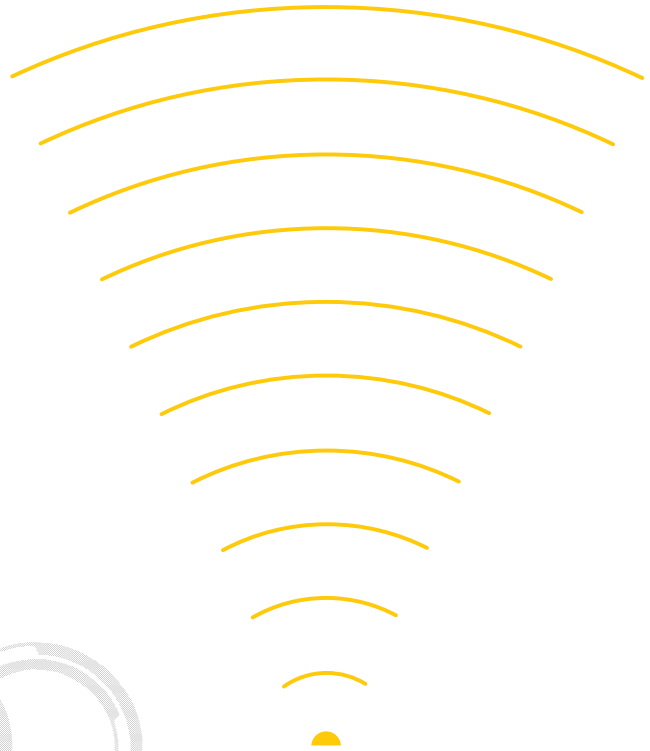

The information listed above is contained in a data message 12 bytes in length. The data transfer is frequency-modulated and the transfer time is approx. 10 ms (refer to description of control unit for tyre pressure monitoring and own wheel recognition).



Each tyre pressure sensor has an individual ID number (ID code) which is used for the purpose of "own wheel recognition".

Copyright. Copying for private or commercial purposes, in part or in whole, is not permitted unless authorised by AUDI AG. AUDI AG does not guarantee or accept any liability with respect to the correctness of information in this document. Copyright by AUDI AG.

You can find further information in the description of the control unit for tyre pressure monitoring.

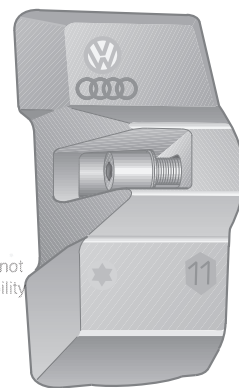

SSP219\_046

# System components

## Temperature cut-out

In order to avoid generating erroneous information, no further radio signals (data messages) are sent when the tyre pressure sensor registers a temperature of approx. 120°C.

Shortly before the tyre pressure sensor switches off the transmitting electronics, the control unit for tyre pressure monitoring is informed that a "temperature cut-out" is imminent. A fault message to this effect is then stored in the fault memory.

If the temperature drops below a defined limit, the sensor will again enter radio mode.

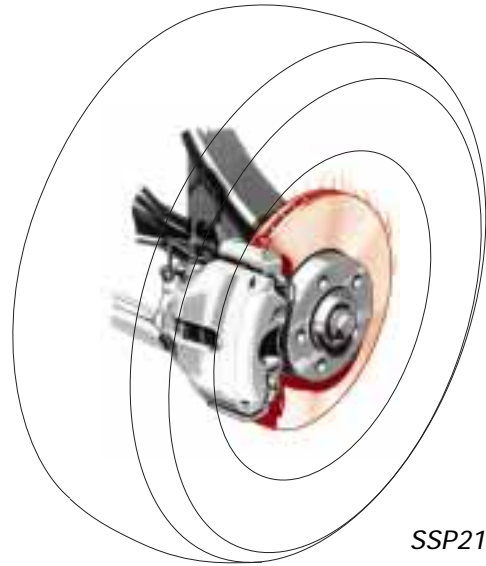

SSP219\_045



Electronic components are sensitive to high temperature. This can cause components to malfunction or fail.

If a temperature cut-out is activated for one or more sensors, the message shown adjacent appears.



SSP219\_040

The power supply to the tyre pressure sensor

The measuring, control and transmitting electronics receive their power supply from an integrated lithium battery.

To prolong the service life of the tyre pressure sensor for as long as possible, the control electronics include an ingenious "Energy Management System".

Protected by copyright. Copying for private or commercial purposes, in part or in whole, is not permitted unless authorised by AUDI AG. AUDI AG does not guarantee or accept any liability for the accuracy of information in this document. Copyright by AUDI AG.



## The Energy Management System

Relatively few measured-data transmissions are sufficient for the tyre pressure measurements. Loss of pressure must, however, be detected immediately and indicated to the control unit.

The Energy Management System differentiates between the normal transfer mode and the high-speed transfer mode, there being various measuring and transfer intervals.

When the tyre pressure readings are constant, the tyre pressure sensor is in normal transfer mode.

If a loss of pressure of more than 0.2 bar per minute occurs, the sensor immediately is switched to a high-speed transfer mode.

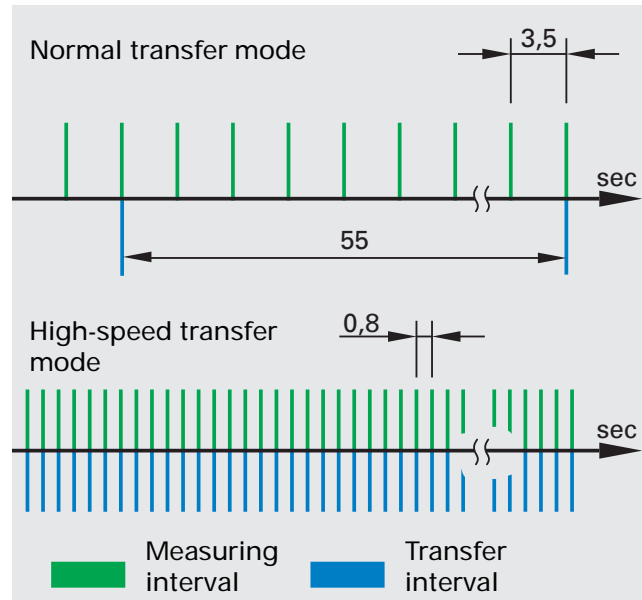

SSP219\_010

The Energy Management System keeps the load on the sensor battery as small as possible and ensures high-reliability monitoring at the same time.

A theoretical battery service life of up to 7 years is therefore possible.

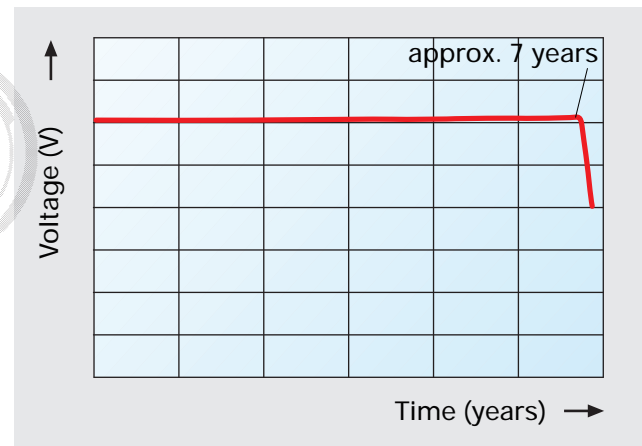

SSP219\_018



The battery is an integral part of the tyre pressure sensor. Batteries cannot be replaced individually.

The theoretical service life can be interrogated via the self-diagnosis (refer to Workshop Manual).

Discharge curve of the lithium battery in the tyre pressure check system

# System components

## Antenna for tyre pressure monitoring R59 ... R62

The antennas for tyre pressure monitoring receive the radio signals from the tyre pressure sensors and transfer them to the control unit for tyre pressure monitoring for further processing.

The tyre pressure check system comprises 4 antennas for tyre pressure monitoring which are installed in the wheel housings at the front left, front right, rear left and rear right behind the wheel housing liners. They are linked to the control unit for tyre pressure monitoring by means of high frequency antenna wiring and assigned to the control unit in accordance with their fitting locations.

The antennas receive all the radio signals within their reception range and frequency band. Each antenna receives the radio signals all in range located wheel sensors.

The radio signals are filtered and selected in the control unit to ensure that the correct data are processed.

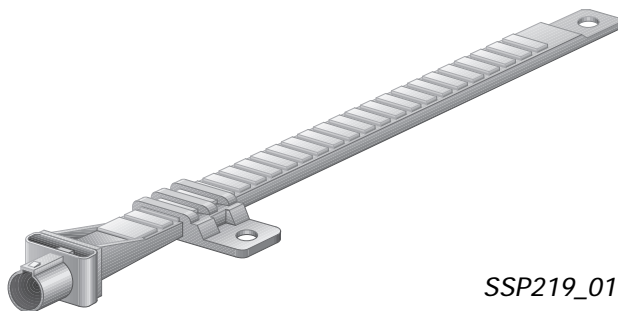

SSP219\_011

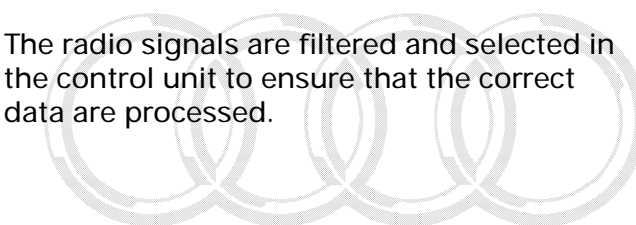

Protected by copyright. Spare parts may not be reproduced, copied, stored in a retrieval system, or transmitted, in any form or by any means, electronic, mechanical, photocopying, recording, or by any information storage and retrieval system, without the prior written permission of Audi AG. Audi AG does not guarantee or accept any liability with respect to the correctness of the information. Copyright by Audi AG.



The tyre pressure check system only works with system components which have the same carrier

frequency (refer to information on tyre pressure sensor).

The carrier frequency is printed on the antennas and can also be identified by the part No.



There is no separate antenna for the spare wheel (you will find more detailed information under "Spare wheel").



Fitting location:

... In the wheel housings, behind the wheel housing liners.

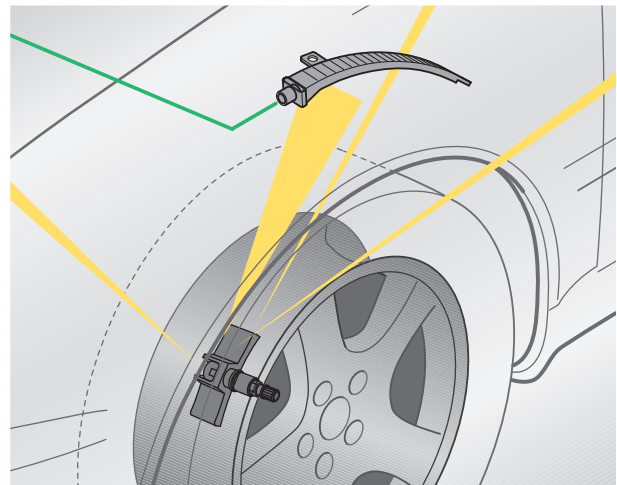

SSP219\_016

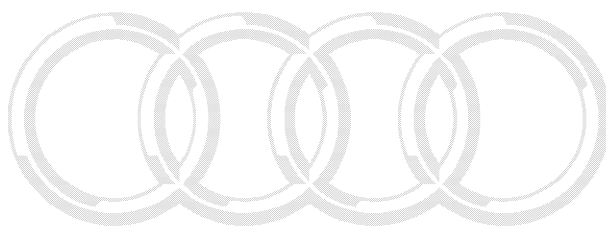

Defective antenna wiring must not be repaired while a high frequency transmission is in progress in order to avoid interference with the transmission!

If an antenna wire is damaged, the cable set must be replaced.

### Self-diagnosis

The antennas for tyre pressure monitoring are currently not monitored by the self-diagnosis.

If "no signal" is entered in the fault memory of the tyre pressure sensor, the antennas and the antenna wiring may also be affected.

Protected by copyright. Copying for private or commercial purposes, in part or in whole, is not permitted unless authorised by AUDI AG. AUDI AG does not guarantee or accept any liability for errors or omissions. Copyright by AUDI AG.

A provision has been made for antenna diagnosis at a later date. You will find information regarding this in the relevant Workshop Manual in due course.



# System components

## Control unit for tyre pressure monitoring J502



The control unit for tyre pressure monitoring evaluates the radio signals from the antennas for tyre pressure monitoring, prioritises these signals and transfers the relevant information to the instrument cluster. Here, corresponding warnings are issued via the display of the driver information system (FIS).

Communication with peripheral components in the vehicle takes place via the convenience CAN databus (also refer to SSP 186 and SSP 213).

The system status messages are prioritised by evaluating different limit values, as well as the pressure drop, as a function of time (pressure drop gradient).

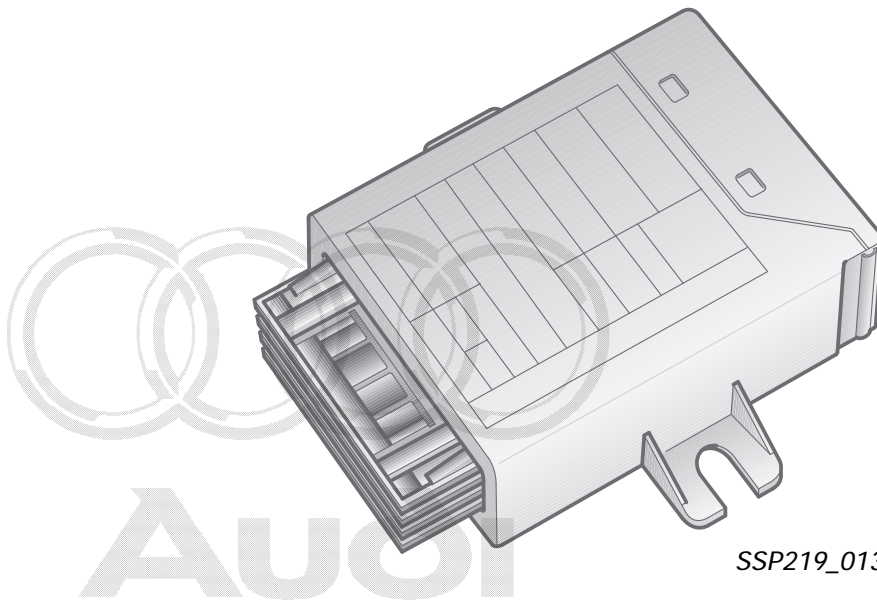

SSP219\_013

Protected by copyright. Copying for private or commercial purposes, in part or in whole, is not permitted unless authorised by AUDI AG. AUDI AG does not guarantee or accept any liability with respect to the correctness of information in this document. Copyright by AUDI AG.



If "Save pressures" is activated, the control unit is asked not only to store the new tyre pressures but also to readapt to the previously stored sensors and their positions (you will find more detailed information under "Own wheel recognition").

For this purpose, two independently stored tyre pressures are saved to the control unit:



1. The tyre pressure for the partly loaded condition and the fully-loaded condition entered with the control unit coding (refer to Workshop Manual - Encoding the control unit).

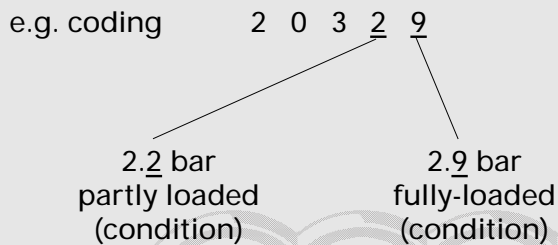

These pressures refer to the data on the sticker affixed to the fuel filler flap and are entered with the help of the coding table. A lower pressure limit is calculated using the pressure for the “partly loaded (condition)” as the starting point (refer to description of system messages)

Protected by copyright. Copying for private or commercial purposes, in part or in whole, is not permitted unless authorised by AUDI AG. AUDI AG does not guarantee or accept any liability with respect to the correctness of information in this document. Copyright by AUDI AG.



The pressures stored via the menu have priority over the encoded tyre pressures until they drop below the lower pressure limit.

# System functions

## Operation

The tyre pressure check system can be switched off and switched on again, and the current tyre pressures can be stored with the function selector switch in the "Tyre pressure" submenu.

### Storing the tyre pressures



To avoid generating faulty signals, it is advisable to execute "Save pressures" function in the FIS menu after checking or correcting the tyre pressures.

Ignoring these instructions and monitoring or correcting the tyre pressures, for example, with different inflating apparatus will lead to premature or delayed system status messages depending upon the tolerances of the inflating apparatus.

This also applies if the tyre pressures are corrected for different tyre temperatures (warm/cold) or different ambient temperatures (summer/winter) and if the pressures are not stored anew each time.

The desired option can be selected with the rotary switch/pushbutton or the function selector switch.

Insert either a small box () or a tick () (refer to operating instructions).

### Switching the system off and on

The system can be switched off by the driver via the menu.

The status message "System switched off" is displayed briefly as information for the driver whenever the ignition is switched.

Activate "Save pressures", and the tyre pressure check system will be switched on automatically.

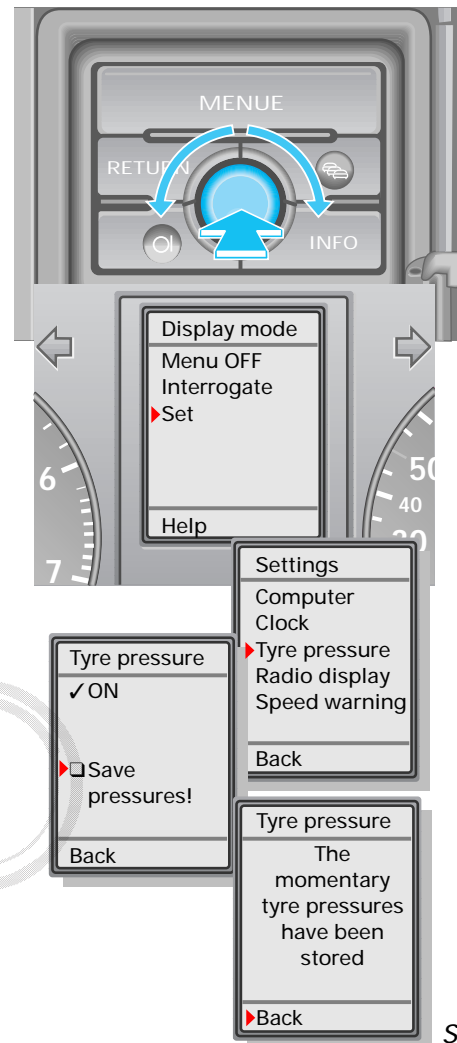

Activate "Save pressures", and the tyre pressures are normalised to 20°C.

To avoid faulty settings, special care must be taken to ensure that the tyre pressures are checked and/or corrected and stored when the tyres are cold.

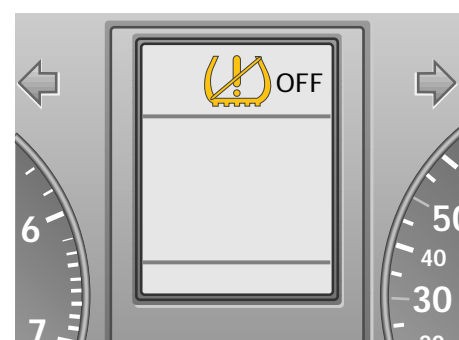

## Status messages

System status messages are divided into two priority levels depending on their effect on the vehicle's handling performance.

Priority 1 messages  
(high significance) ...

Priority 2 messages  
(low significance) ...

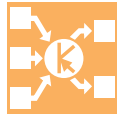

... are intended for system states in which driving safety is no longer assured. Priority 1 status messages are indicated by red warning symbols on the FIS display and by acoustic signals (gong). The driver is asked to check the condition of the tyres immediately.

... are intended for system states which are non-critical with regard to driving safety. The driver is informed about the condition of the system by yellow symbols on the FIS display.

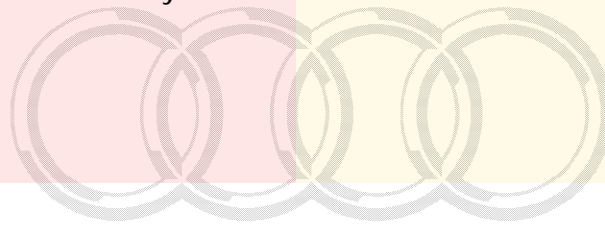

As a rule, priority 1 and 2 status messages are subdivided into "no position" and "position-related".

"No position" means that the system cannot give exact information regarding the fault location or that there are several fault locations which lead to the status message "no position".

"Position-related" means that the system can determine the fault location exactly and only this location can be responsible for causing the fault.

Priority 1 messages

are displayed for the following conditions:

- if the ACTUAL tyre pressure drops below alarm threshold 2
- if the ACTUAL tyre pressure drops below alarm threshold 3 (refer to Page 25, figure 022)
- if the pressure loss gradient greater than 0.2 bar/min

# System functions

Priority 1 messages

Rapid loss of pressure

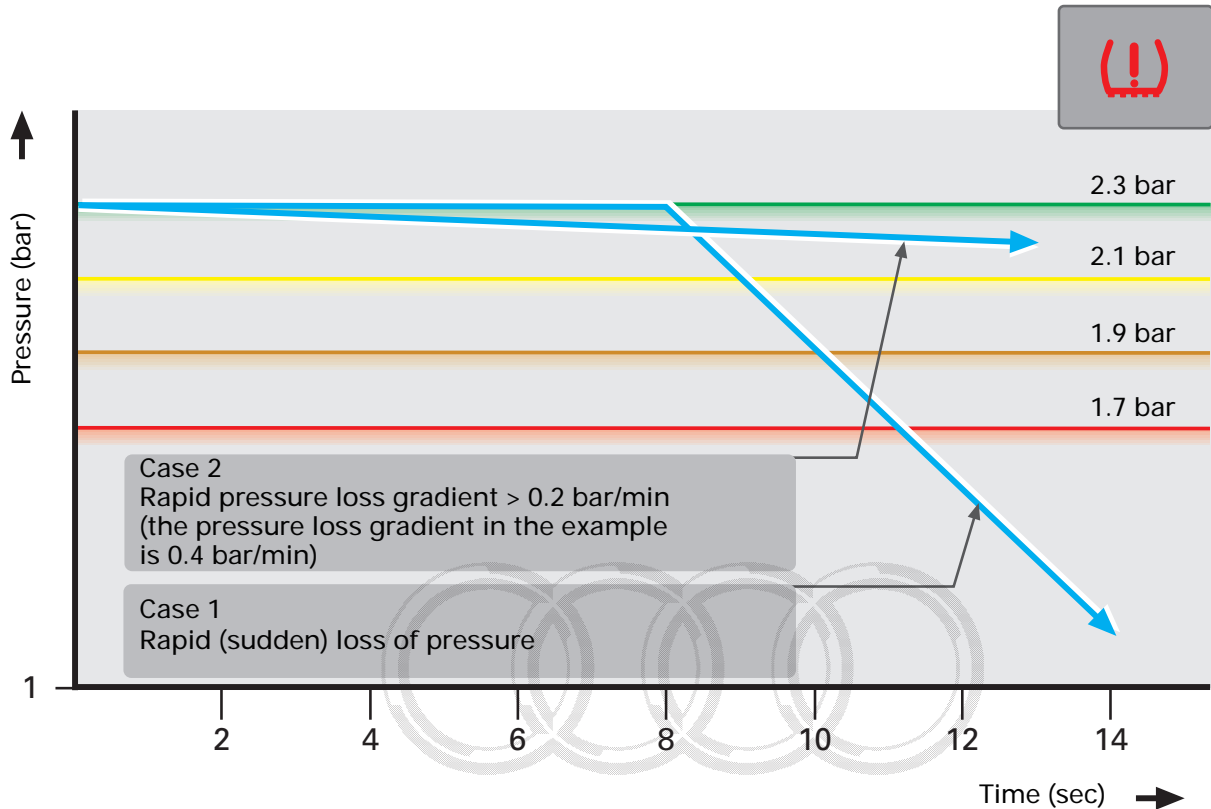



 Specified tyre pressure stored by means of menu

 Alarm threshold 3 ...  
... is the lower pressure limit calculated from the coded tyre pressure for the partly loaded condition.

 Actual tyre pressure

Protected by copyright. Copying for private or commercial purposes, in part or in whole, is not permitted unless authorised by AUDI AG. AUDI AG does not accept any liability with respect to the correctness of information in this document. Copyright by AUDI AG.

 Alarm threshold 1 ...  
... is 0.2 bar below the specified tyre pressure stored by means of the menu

 For example, the lower pressure limit is 1.7 bar at a specified inflation pressure of 2.2 bar according to the coding table (manufacturer's specifications for partly loaded condition for Audi A8).

 Alarm threshold 2 ...  
... is 0.4 bar below the specified tyre pressure stored by means of the menu



Priority 1 messages are displayed straight after an evaluation has been made.

A priority 1 message is always displayed as from alarm threshold 3!

The priority 1 messages listed below can be displayed:

This status message (priority 1, no position) appears when at least one of the conditions for priority 1 (also refer to page 21) is fulfilled and a definite wheel position cannot be assigned.

One or more wheels may be affected.

This status message may also pertain to the spare wheel in certain conditions (for more detailed information, please refer to "Spare wheel").

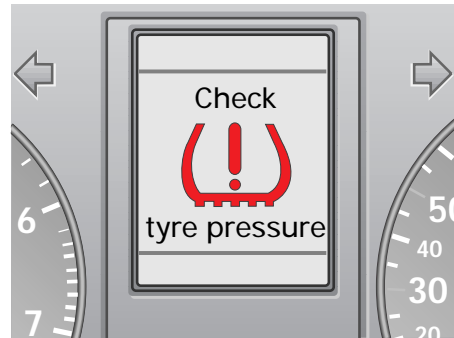

SSP219\_031

This status message (priority 1, position-related) differs from the previously described message in that a definite wheel position could be determined

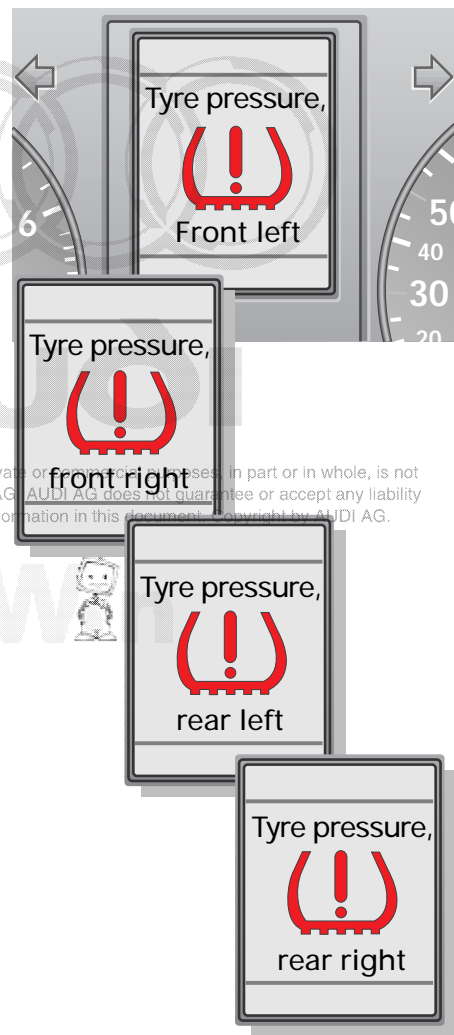

SSP219\_032

Protected by copyright. Copying for private or professional use, in part or in whole, is not permitted unless authorised by AUDI AG. AUDI AG does not guarantee or accept any liability with respect to the correctness of information in this document. Copyright by AUDI AG.

# System functions

This message is displayed when the "Check" key is pressed while a priority 1 status message is being indicated.



SSP219\_032

If the navigation system is active, all priority 1 messages are indicated by this pictogram after a short while (first full screen, then small-format display).

It appears in the upper segment of the Driver Information Display so as not to disrupt route guidance.



SSP219\_034

# Audi

Protected by copyright. Copying for private or commercial purposes, in part or in whole, is not permitted unless authorised by AUDI AG. AUDI AG does not guarantee or accept any liability with respect to the correctness of information in this document. Copyright by AUDI AG.

The priority 1 messages are cancelled if:



- all sensors receive a tyre pressure over the 1st alarm threshold (0.2 bar under the stored specified tyre pressure),
- the pressures are stored anew (via the menu).

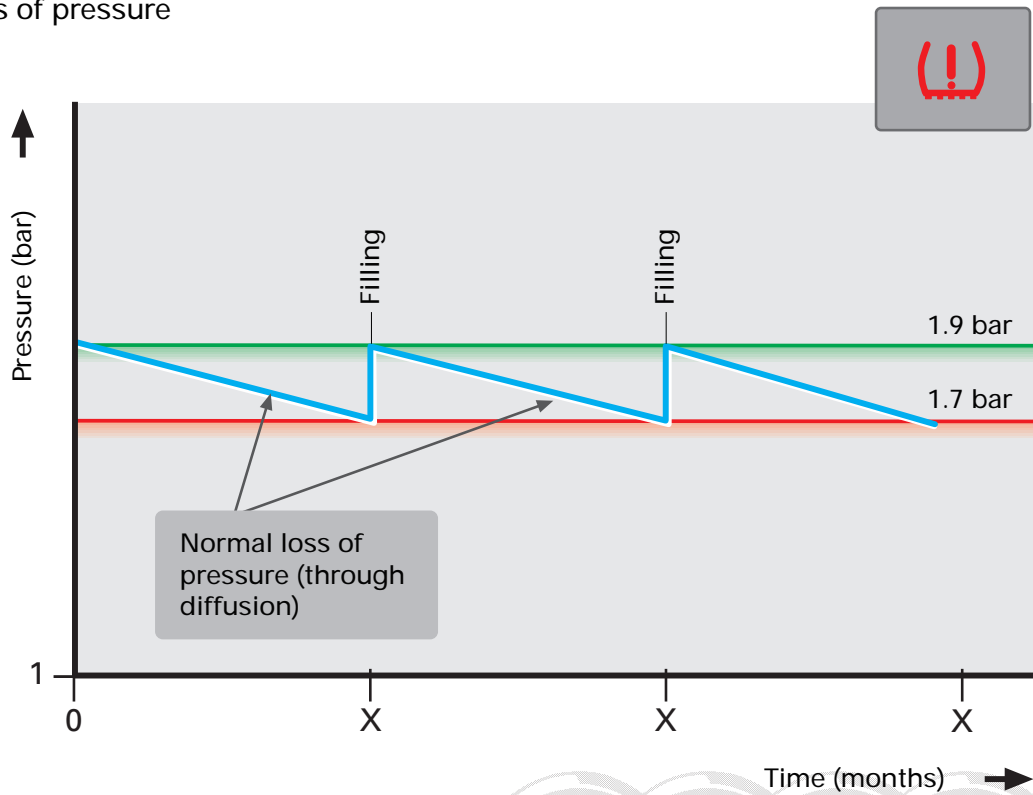

Wrong setting

Slow loss of pressure



-  Specified tyre pressure stored by means of menu
-  Actual tyre pressure
-  Alarm threshold 3 ...  
... is the lower pressure limit calculated from the coded tyre pressure for the partly loaded condition.

For example, the lower pressure limit is 1.7 bar at a specified inflation pressure of 2.2 bar according to the coding table (manufacturer's specifications for partly loaded condition for Audi A8).

This diagram shows a wrong setting. Alarm threshold 3 results from the coded tyre pressure for the partly loaded condition. A priority 1 message is always displayed as from alarm threshold 3. In this example, a priority 1 message is displayed when the tyre pressure drops below a pressure of 0.2 bar.

Protected by copyright. Copying for private or commercial purposes, in part or in whole, is not permitted unless authorised by AUDI AG. AUDI AG does not guarantee or accept any liability with respect to the correctness of information in this document. Copyright by AUDI AG.



A priority 1 message is always displayed as from alarm threshold 3!

# System functions

Priority 2 messages are displayed under the following conditions:

- A) if the ACTUAL tyre pressure reaches or exceeds alarm threshold 1
- B) if the pressure differential at the wheels on the same axle is greater than 0.4 bar
- C) if the system is switched off or unavailable due to faults

Priority 2 messages

Slow loss of pressure

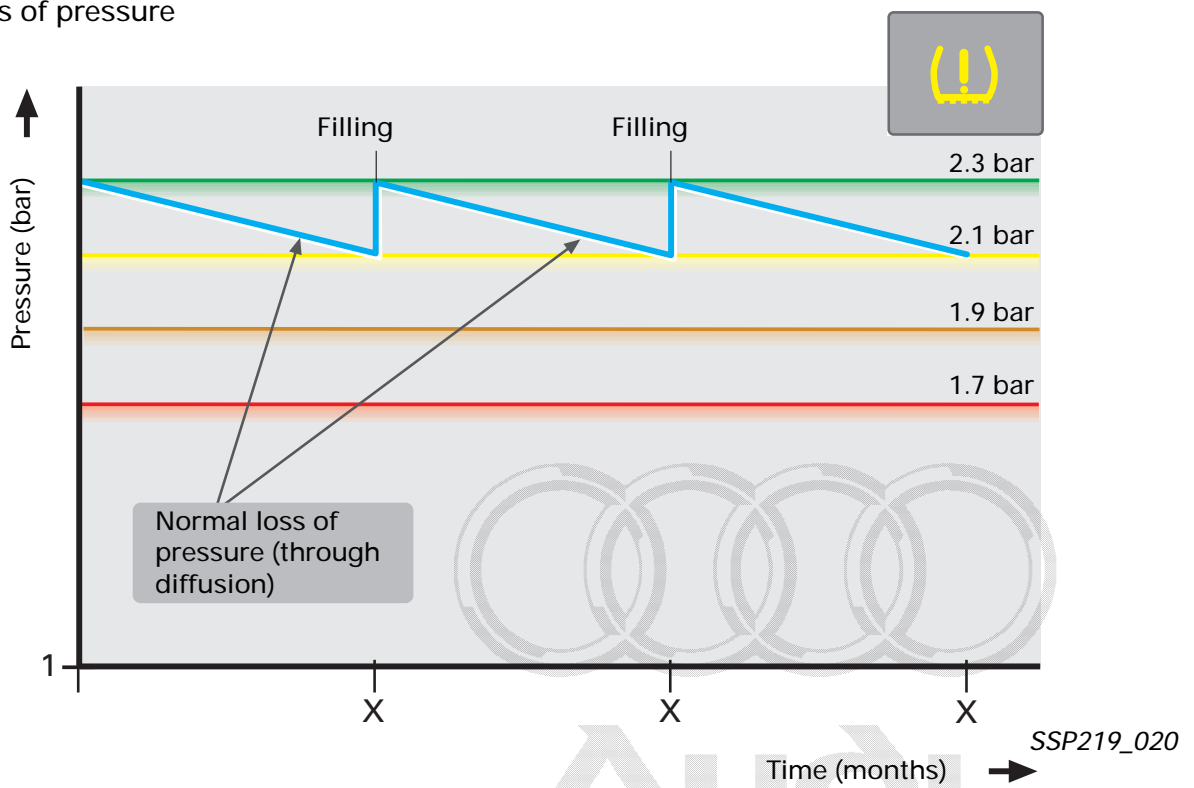

- Specified tyre pressure stored by means of menu
- Actual tyre pressure
- Alarm threshold 1 ...  
... is 0.2 bar under the specified tyre pressure stored by means of the menu
- Alarm threshold 2 ...  
... is 0.4 bar under the specified tyre pressure stored by means of the menu

Protected by copyright. Copying for private or commercial purposes, in part or in whole, is not permitted unless authorised by AUDI AG. AUDI AG does not guarantee or accept any liability with respect to the correctness of the information.

**Alarm threshold 3 is the lower pressure limit calculated from the coded tyre pressure for the partly loaded condition.**

For example: the lower pressure limit is 1.7 bar at a specified inflation pressure of 2.2 bar according to the coding table (manufacturer's specifications for partly loaded condition for Audi A8).

## Messages regarding A)

These messages are displayed when the ACTUAL tyre pressure in a wheel is 0.2 bar less than the specified tyre pressure stored via the menu (alarm threshold 1).

At the same time, the control unit for tyre pressure monitoring must know the positions of the tyre pressure sensors (priority 2, position-related).

In addition, a difference of more than 0.1 bar between actual tyre pressure and the stored specified tyre pressure must not be received from any of the other 3 sensors.

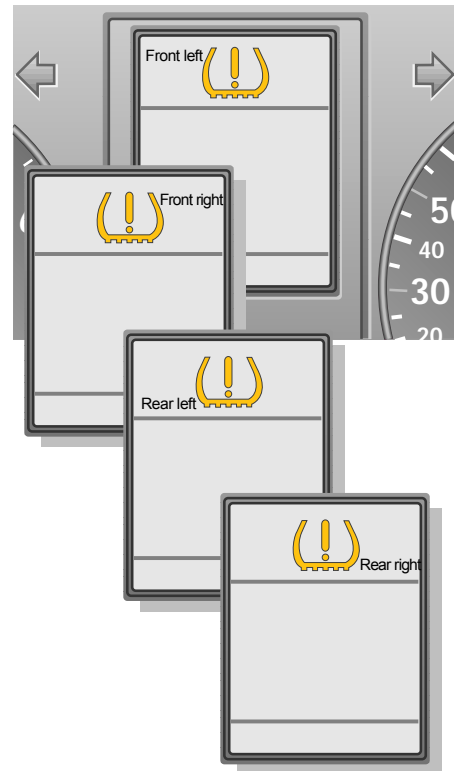

SSP219\_035

If a wheel reaches alarm threshold 1 and if one or more of the other wheels is 0.1 bar below the stored specified tyre pressure, the message "no position" is displayed.

In this way, the driver is prompted to check and/or correct the tyre pressures of all wheels.

This prevents system alarms being indicated too frequently.



SSP219\_036



If position recognition has still not been performed, no priority 2 messages which fall under "A and B" are displayed.

# System functions

Further conditions relating to A):

The temperature value transferred by the sensors must not be more than 15 °C above the ambient temperature when the ignition is turned "on". If this temperature threshold is exceeded, the alarm message is suppressed.



The alarm messages described under A) are not displayed until the ignition is switched on again.

The alarm messages described under A) are cancelled:

- if a tyre pressure which deviates from the stored specified tyre pressure by less than 0.1 bar is received from all sensors
- if the pressures are stored anew (via menu)

Alarm messages relating to B)

These messages are displayed when the pressure differential between the wheels on an axle (front axle, rear axle or on both axles) is greater than 0.4 bar.

This may also be the case if tyre pressure correction is not performed properly (if a wheel has been omitted).

The driver must check or correct the tyre pressures again or and then repeat the function "Save pressures".

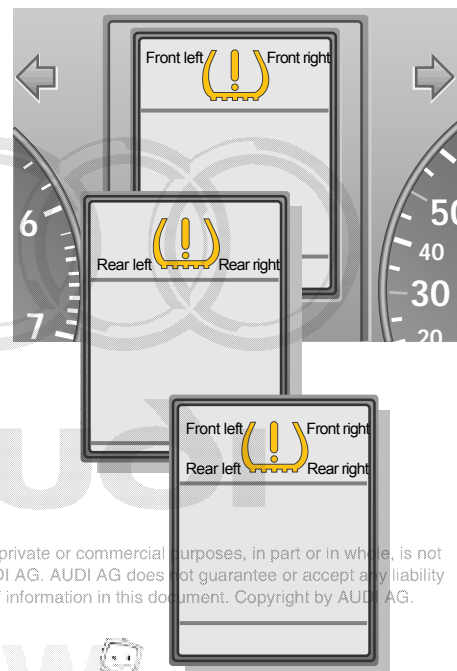

The alarm messages described under B) are displayed straight after the evaluation is performed.

Protected by copyright. Copying for private or commercial purposes, in part or in whole, is not permitted unless authorised by AUDI AG. AUDI AG does not guarantee or accept any liability with respect to the correctness of information in this document. Copyright by AUDI AG.



SSP219\_037

Further conditions relating to B):

The temperature values determined by the sensors must not be more than 30°C above the ambient temperature. The alarm message is suppressed when this temperature threshold is exceeded.

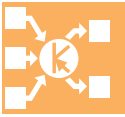

The alarm messages described under B) are cancelled:

if the pressures stored anew (via menu).

Alarm messages relating to C)

The system can be deactivated by the driver via the menu.

This is expedient for example when wheels fitted with tyre pressure sensors (e.g. winter wheels) are transported in the luggage compartment or when wheels without sensors are mounted.

This status message is displayed briefly as information for the driver whenever the ignition is turned on.

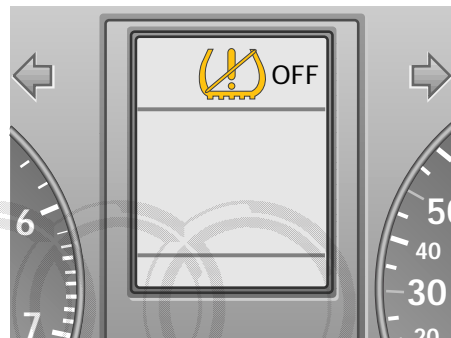

SSP219\_038

# Audi

Protected by copyright. Copying for private or commercial purposes, in part or in whole, is not permitted unless authorised by AUDI AG. AUDI AG does not guarantee or accept any liability with respect to the correctness of information in this document. Copyright by AUDI AG.

erWin 

# System functions

If the system is not available due to radio frequency interference, this is indicated to the driver with this message.

This may be the case if for example the sensors receive no data messages due to electromagnetic fields. Possible interference factors include auxiliary spark gaps (spark plug socket not inserted correctly) or the use of infrared headphones.

The message is cancelled if the radio frequency interference is no longer present and the data messages from the sensors have been received.



SSP219\_039



This message is only indicated at vehicle road speeds greater than 5 kph.

This message is indicated in the event of other system disturbances, indicating that the tyre pressure check system is not available (refer to "Temperature cut-out").



SSP219\_040

## Examples:

Fault in system (open circuit, control unit for tyre pressure monitoring defective etc.)

No radio signals are received from the tyre pressure sensors (after fitting snow chains or wheels without sensors).

The own wheel recognition and position recognition operations were not completed within a driving time of 30 min.

If data messages are received from more than 5 sensors while travelling (transportation of wheels with sensors in the luggage compartment)

If the control unit for tyre pressure monitoring has detected an erroneous code or is not encoded.

## Own wheel recognition

Each tyre pressure sensor has its own ID code in the form of a 10-character number. The ID codes are contained in the data messages of the sensors and are transferred continuously to the control unit. They are used for assigning the sensors to the vehicle.

The control unit for tyre pressure monitoring defines and stores the sensors belonging to vehicle under specific conditions.

This process is referred to as "own wheel recognition".

Up to 5 sensors can be "managed" (incl. spare wheel). The ID codes received are compared continuously with the ID codes stored in the memory, and the data messages of the stored sensors are processed.

This ensures that "outside sensors" located within radio reception range do not affect the system.

The own wheel recognition system is an adaptive system. The control unit recognises when wheels fitted with different sensors are mounted for example. The "new sensors" are adopted and stored under specific conditions (algorithmic evaluation).

Sensors are only adapted while the vehicle is travelling. This protects the vehicle against interference by, for example, vehicles with tyre pressure check system parked in the vicinity.

Control unit for tyre pressure monitoring J502

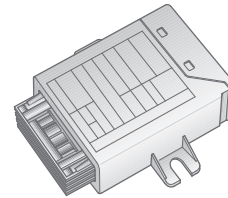

List of own wheels (ID code)

1 ... 0000578100  
 2 ... 0000597200  
 3 ... 0000598100  
 4 ... 0000602300  
 5 ... 0000755100

List of wheel positions (ID code)

VL ... 0000755100  
 VR ... 0000597200  
 HL ... 0000602300  
 HR ... 0000578100  
 RR ... 0000598100

ID codes

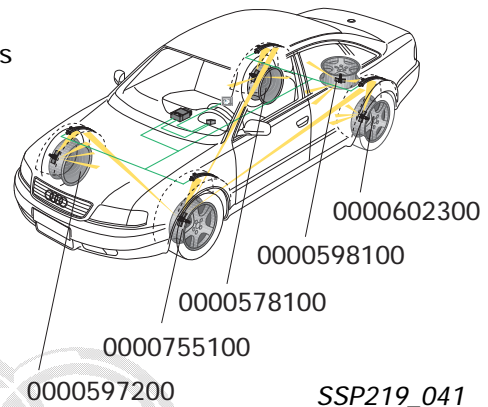

SSP219\_041

Transporting wheels with fitted tyre pressure sensors on board the vehicle are a source of interference and may cause the system to generate erroneous information.

The ID codes of the individual sensors can be displayed under various display groups with the diagnostic system tester function 08 - Read data block



When the function "Save pressures" is invoked in the menu, the control unit is requested to repeat own wheel recognition and position assignment in addition to storing the new tyre pressures.



not intended for private, non-commercial use or commercial purposes. Audi AG does not assume any liability with respect to the correctness of information in this document. Copyright by AUDI AG.



# System functions

## Position recognition

To be able to display position-related alarm messages to the driver, the control unit for tyre pressure monitoring must know the fitting locations of the sensors on the vehicle.

The position recognition function is an additional function of the control unit. It assigns the sensors automatically and independently to the fitting locations of the wheels on the vehicle at the front left, front right, rear left and rear right, as well as the spare wheel.

This is made possible by the use of 4 receiver antennas and by evaluating the reception signals of varying strength from the individual sensors.

The control unit determines the theoretical positions of the sensors (fitting locations of the wheels at the front left, front right, rear left and rear right, as well as the spare wheel) by means of algorithmic calculations and statistics.

In view of the fact that a great many factors can have an effect on signal strength and received signal strength in radio transmission (e.g. shielding by metal parts, distance from transmitter to antenna, environmental influences etc.), 100% location of the sensor position is not always assured. The term "theoretical position" is therefore used.

### Monitoring function when vehicle is stationary

To ensure that the monitoring function also works when the vehicle is stationary, the control unit for tyre pressure monitoring remains active after the ignition has been turned off. The control unit enters energy-saving mode. It self-activates shortly before the data messages are transmitted (at regular intervals) by the wheel sensors.

Control unit for tyre pressure monitoring J502

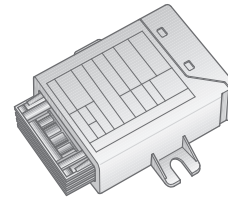

List of own wheels (ID code)

1 ... 0000578100  
2 ... 0000597200  
3 ... 0000598100  
4 ... 0000602300  
5 ... 0000755100

List of wheel positions (ID code)

VL ... 0000755100  
VR ... 0000597200  
HL ... 0000602300  
HR ... 0000578100  
RR ... 0000598100

ID codes

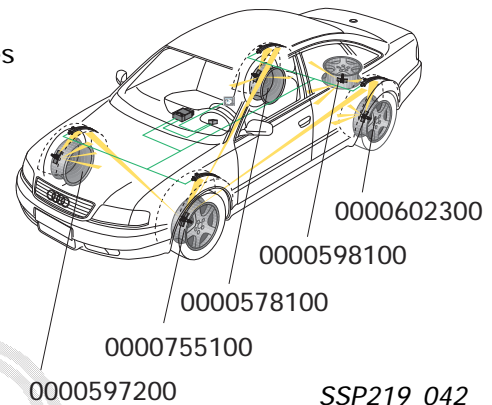

SSP219\_042

not for commercial purposes. Audi AG does not guarantee or accept any liability with respect to the correctness of information in this document. Copyright by AUDI AG.

This function preserves the vehicle battery charge and ensures that a flat tyre is indicated before setting off.



## Spare wheel

The spare wheel has a special status in the tyre pressure check system. It is also equipped with a tyre pressure sensor. Unlike the other wheels, the tyre pressure check system does not have its own antenna for tyre pressure monitoring.

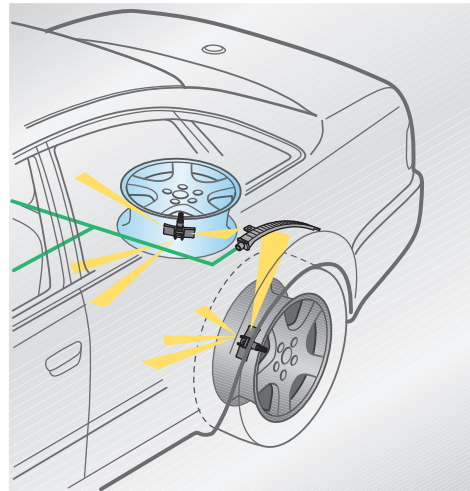

SSP219\_043

The antennas receive the radio signals (data message) which the spare wheel sends and transfer these signals to the control unit for tyre pressure monitoring. The own wheel and position recognition functions identify the "fifth wheel" as a spare wheel, and it is registered in the control unit as such.



The tyre pressure in the spare wheel can be monitored using the diagnostic system testers function 08 "Read data block ", Display group 13.

The prerequisite for this is that the position recognition process has been completed.

This is the case when "015" is displayed under Display group 19.

Although the control unit "manages" the spare wheel, system alarm messages pertaining to spare wheel are suppressed and not indicated.



The priority 1 message "no position" may also pertain to the spare wheel if the tyre inflation pressure is below alarm threshold 3, provided that position recognition has still not been performed (e.g. after "Save pressures" or after a wheel change).

The message is cancelled once position recognition has been completed (the spare wheel is recognised as such).

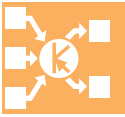

# System functions

## Convenience CAN interface

Information interchange between the control unit for tyre pressure monitoring and the vehicle is performed via the instrument cluster by means of the convenience CAN-bus system.

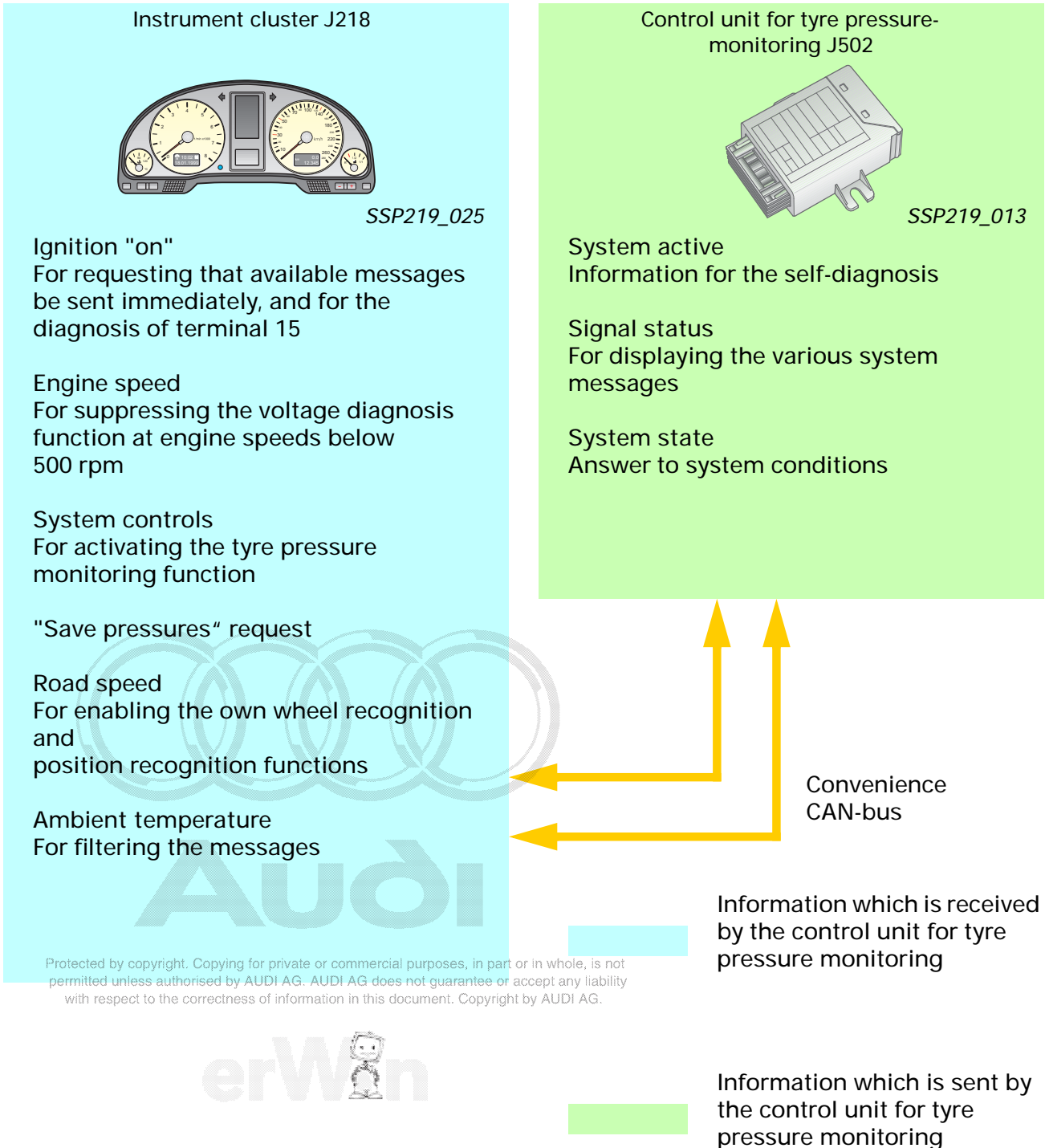
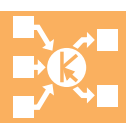

Protected by copyright. Copying for private or commercial purposes, in part or in whole, is not permitted unless authorised by AUDI AG. AUDI AG does not guarantee or accept any liability with respect to the correctness of information in this document. Copyright by AUDI AG.



## Self-diagnosis

An extensive self-diagnosis function for quick fault-finding can be activated through the vehicle diagnosis interface.

Please refer to the current Workshop Manual.

Address word: 65

Possible functions:

- 01 - Interrogate control unit version
- 02 - Interrogate fault memory
- 05 - Erase fault memory
- 06 - End of output
- 07 - Encode control unit
- 08 - Read data block
- 10 - Adaptation

There is a facility for activating the antenna diagnosis (test run) using adaptation channel 10.

Refer to the description of the antenna for tyre pressure monitoring/self-diagnosis.

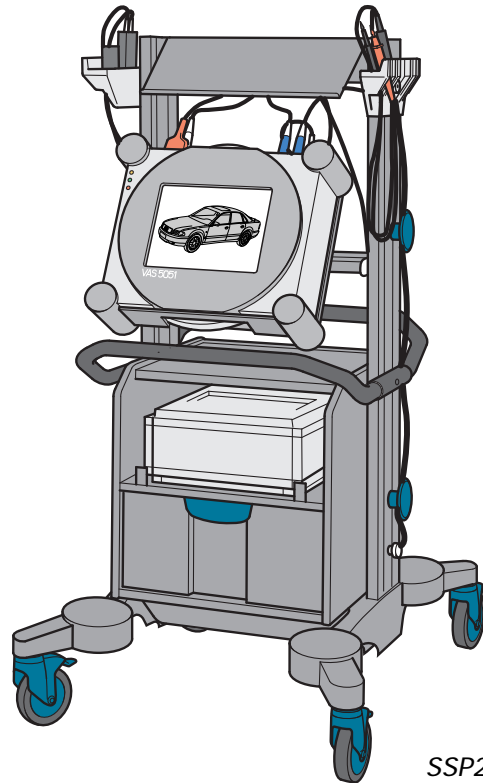

SSP219\_023

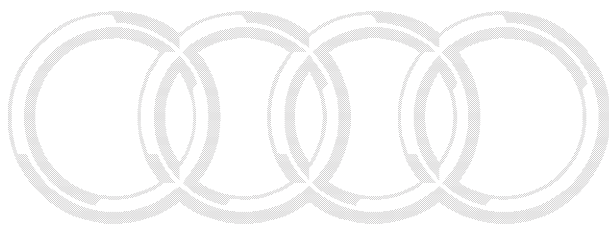

# Audi

Protected by copyright. Copying for private or commercial purposes, in part or in whole, is not permitted unless authorised by AUDI AG. AUDI AG does not guarantee or accept any liability with respect to the correctness of information in this document. Copyright by AUDI AG.





**Audi**

Protected by copyright. Copying for private or commercial purposes, in part or in whole, is not permitted unless authorised by AUDI AG. AUDI AG does not guarantee or accept any liability with respect to the correctness of information in this document. Copyright by AUDI AG.



All rights reserved. Subject to  
change without notice.  
**AUDI AG**  
Dept. I/VK-5  
D-85045 Ingolstadt  
Fax ++49 (0) 841/89-36367  
940.2810.38.20  
Technical status 06/99  
Printed in Germany