



Audi TT Roadster

Self-Study Programme 391

Audi Hungaria Motor Kft.

The engine plant at Győr, Hungary, was inaugurated in October 1994.

The plant is not only central to the international competitiveness of company, it also creates in Hungary a solid strategic base that continues to grow in importance.

Virtually the entire Audi range of engines is now assembled in Győr.

Volume production of TT models commenced in April 1998.

By the end of 2005, 265,241 Audi TT Coupés and TT Roadsters as well as 36,458 Audi A3 and S3 models had rolled off the Győr assembly lines.

For commercial purposes, in part or in whole, is not guaranteed or accepted any liability in this document. Copyright by AUDI AG.



The plant

Location: Győr, Hungary

Company formation: February 1993

Land purchase and construction of the building carcass in April 1993

Site area: 1,659,163 m²

Developed area: 388,480 m²

Logistic links to road and rail infrastructure

Workforce: 5,022 (as at 31.12.05)

Production of engines and engine components as well as vehicle assembly

Engine development centre with flanking development activities during series production

Production planning

Tool making

The new Audi TT Roadster

Unfiltered sportiness, a truly authentic driving experience plus high power reserves – cue the new TT Roadster from Audi. The open-top sports car has taken all the design cues from its tremendously successful predecessor, but instills them with even greater emotion, performance and dynamics.

With its rigorous geometry and clarity, the design of the first TT Roadster elevated it to the status of a cult classic. In designing the new TT Roadster Audi has preserved this charismatic stylistic idiom and carefully honed it for the new model.

Whereas the tail end and the roof section seem to flow into one another at the rear of the TT Coupé, the convertible top of the TT Roadster forms a clear contrast that gives the overall design a more geometric look.

This impression is underscored by the athletic curves of the vehicle's flanks just as much as by the rising dynamic line above the sill area and the taut, muscular shoulder line.

The TT Roadster has a lightweight fabric convertible top which fits in perfectly with the philosophy of puristic open-top motoring and also offers a number of benefits over a folding steel hard top. It is very light and takes up only a small amount of space when folded down. The roof is manually operated or electro-hydraulically powered.

Like the TT Coupé, the body of the TT Roadster is also built on the principles of Audi Space Frame ASF® technology, featuring a pioneering hybrid construction that showcases the brand's tremendous expertise in lightweight design.

Protected by Copyright. Copying for private or commercial purposes, in part or in whole, is not permitted unless authorised by AUDI AG. AUDI AG does not guarantee or accept any liability with respect to the correctness of information in this document. Copyright by AUDI AG.



Contents

Introduction

In brief	6
Engine-gearbox combinations	7

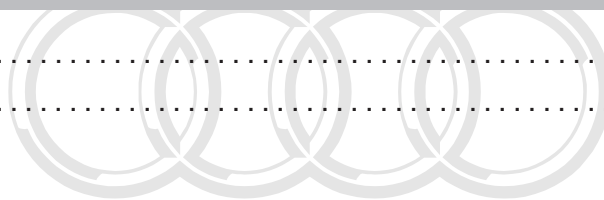

Bodyshell

Technical profiles	8
--------------------------	---

Protected by copyright. Copying for private or commercial purposes, in part or in whole, is not permitted unless authorised by AUDI AG. AUDI AG does not guarantee or accept any liability with respect to the correctness of information in this document. Copyright by AUDI AG.

Convertible top

Convertible top design	10
------------------------------	----

Electrical convertible top control system

Installation locations of the system components	12
Automatic convertible top operation	14
Emergency operation	18
Components of the convertible top control system	20
System overview	28
Topology and networking	30
Data exchange	32
CAN data bus interfaces	33
Function diagram	34

Hydraulics

Hydraulic system	36
------------------------	----

Convenience electronics

Windbreak	38
-----------------	----

Running gear

Overview	40
Rear axle	41

Heating and air conditioning system

Heating system	42
----------------------	----



Interior monitoring

Anti-theft alarm system	44
-------------------------------	----

Protected by copyright. Copying for private or commercial purposes, in part or in whole, is not permitted unless authorised by AUDI AG. AUDI AG does not guarantee or accept any liability with respect to the correctness of information in this document. Copyright by AUDI AG.

Infotainment

Radios and radio navigation systems	45
Sound system	46
Aerials	48

The Self-Study Programme teaches the design and function of new vehicle models, automotive components or technologies.

The Self-Study Programme is not a Repair Manual!
The values given are intended as a guideline only and refer to the software version valid at the time of publication of the SSP.

For maintenance and repair work, always refer to the current technical literature.

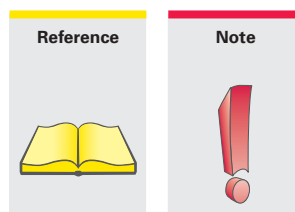

Introduction

Overview

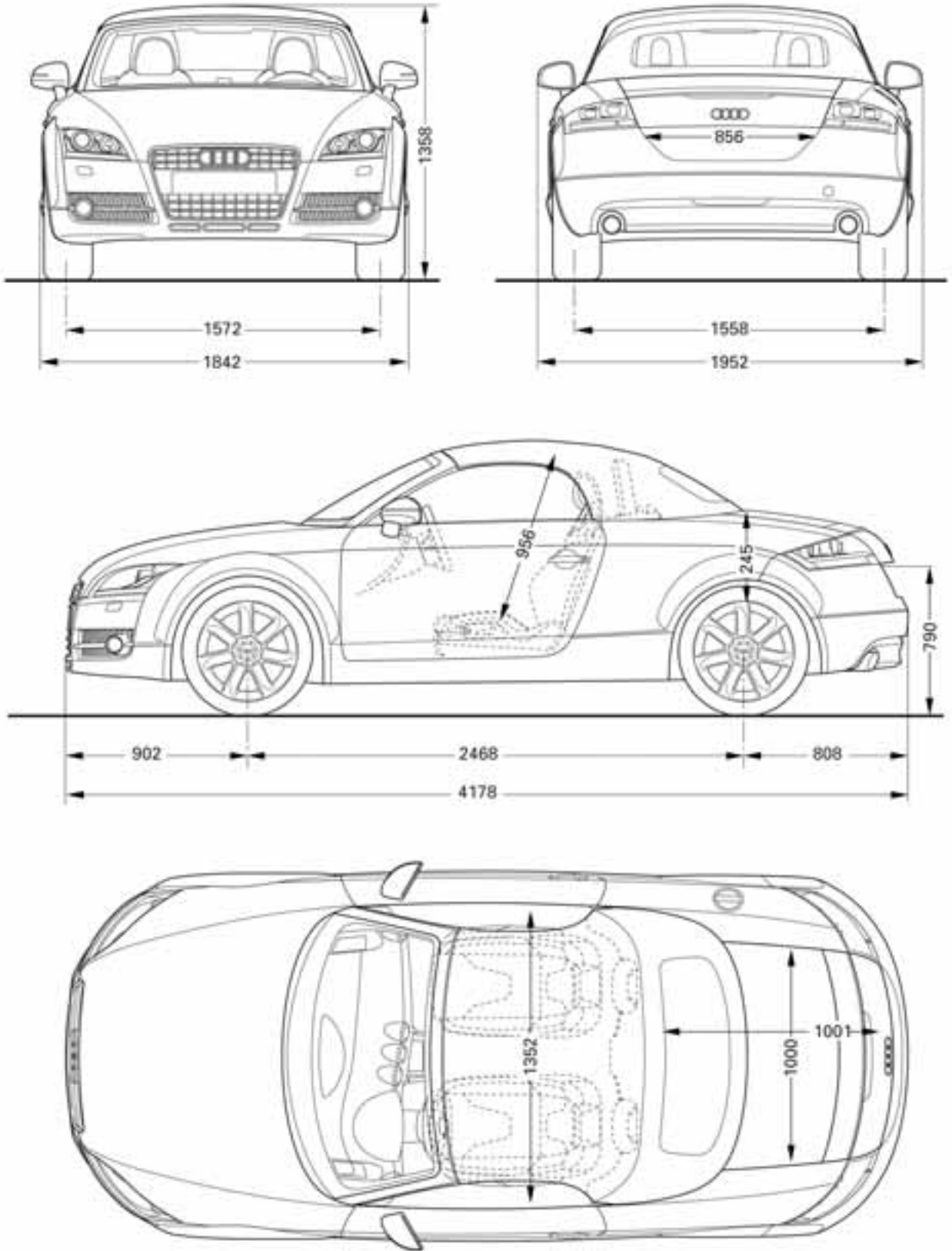

is not
ability
3.

Engine-gearbox combination

2.0l TFSI engine



391_090

Direct manual gearbox 02E front-wheel drive
Six-speed manual gearbox 02Q front-wheel drive



391_095

3.2l V6 MPI engine



391_091

Direct manual gearbox 02E four-wheel drive
Six-speed manual gearbox 02Q four-wheel drive



391_096

Reference

For information on the design and function of the S tronic gearbox, refer to Self-Study Programme 386 "Six-speed Twin Clutch Gearbox 02E".



Reference

For further information on engines and fuel supply systems, refer to Self-Study Programme 380.



Bodyshell

Technical profiles

The Audi Space Frame ASF[®] with its innovative material mix of aluminium (58 %) and steel (42 %) is the ideal solution to the severe demands on the bodyshell of a roadster.

A balanced weight distribution was achieved by using aluminium in the forward section of the body and steel in the rear section and in the roll cage stiffening frame.

The roll bars integrated in the body structure create a survival space for the occupants in the event of a roll-over.

In order to brace the windscreen frame, a high-strength steel tube has been integrated.

A very high level of passive safety has been achieved as a result of these modifications.

With a special hybrid construction that makes intelligent use of aluminium and steel, the new Audi TT Roadster scores top marks for high strength and rigidity.

Thus, the TT Roadster has all the credentials for dynamic handling, high roll and vibration comfort as well as excellent occupant protection.

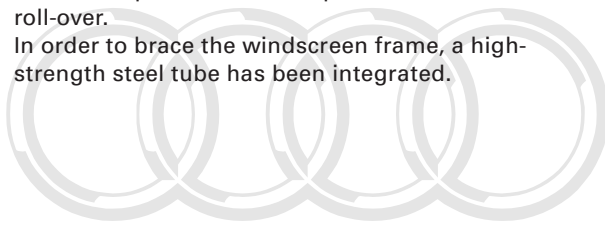

Audi

Prot
per
v



391_039



The intelligent use of steel and aluminium results in a well-balanced weight distribution as well as outstanding strength and rigidity.

The extruded aluminium sills significantly increase the rigidity of the bodyshell. The much higher rigidity is achieved thanks to a modified inner geometry. The result is best-in-class static torsional rigidity.

These impressive results are basically attributable to three factors:

- selective use of materials according to their function
- the special bodyshell construction
- Audi's cutting-edge expertise in the use of aluminium as a body material, and in particular the Audi Space Frame ASF® design concept

Reinforced A-post with reinforced windscreen frame and door sills



Protected by copyright. All rights reserved. No part of this document may be reproduced, stored in a retrieval system, or transmitted, in any form or by any means, electronic, mechanical, photocopying, recording, or by any information storage and retrieval system, without the prior written permission of the copyright owner.

391_025

Extruded section sill



391_033

Rigidity has been further enhanced by extensive modifications to the sill architecture.

Convertible top

Convertible top design

Fabric convertible top with space-saving folding system

A special new feature of the new Audi TT Roadster is the Z-fold system of the fabric convertible top, as a result of which the convertible top takes up only a small amount of space when folded down. With this space-saving folding system, the front section of the roof lies on top of the cloth like a cover and locks into place to lie flush with the body.

The side openings for the drive motor of the convertible top mechanism are covered by convertible top flaps. As a result, there is no need for a tonneau. The linkage for both the fully automatic and manual convertible tops is made from a combination of steel and aluminium components and, as a result, is exceptionally light.

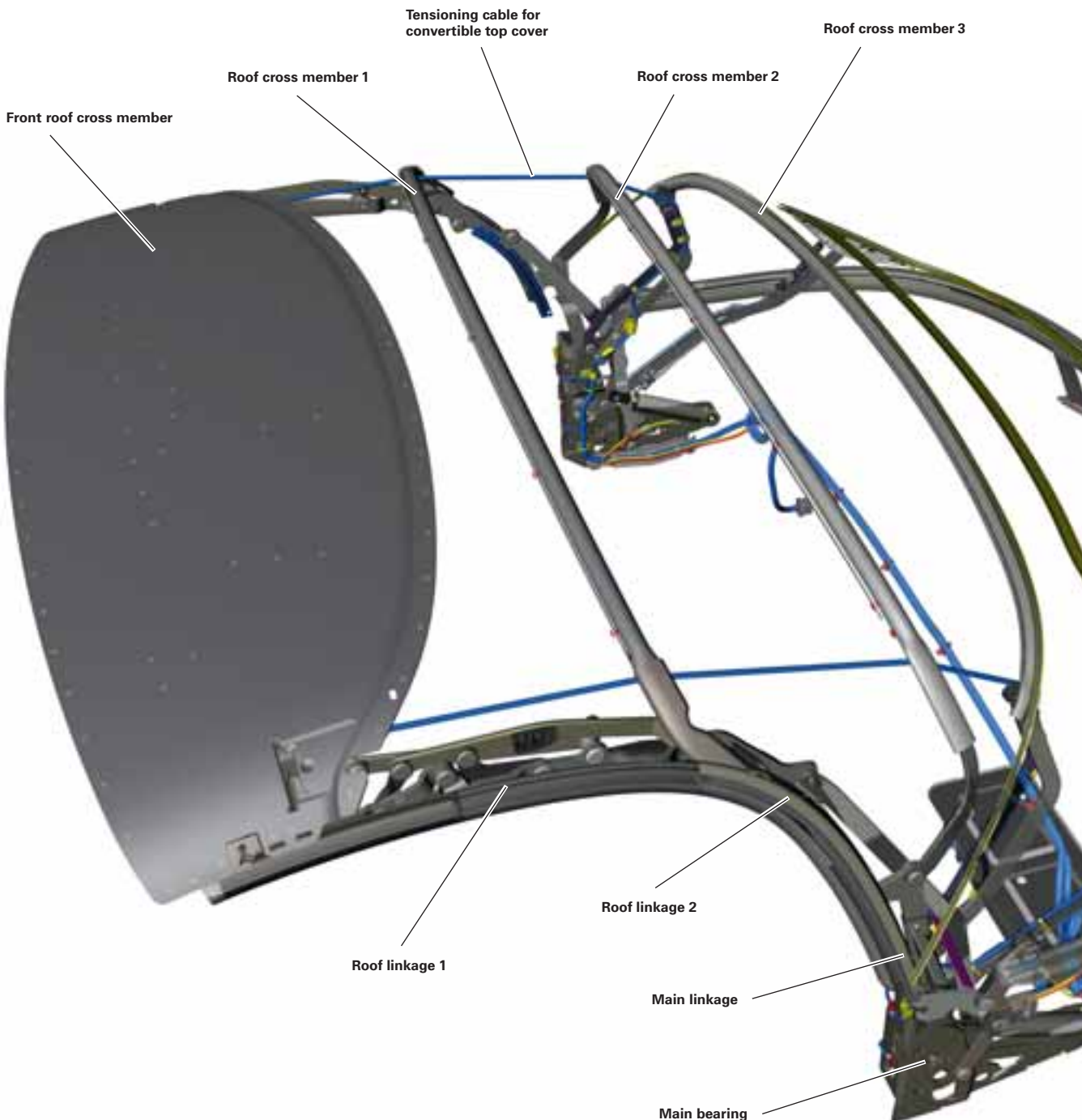

Convertible top cover

Convertible top lock with drive

Headliner

Tensioning strap for roof cross member

whole, is not
pt any liability
AUDI AG.

391_043

Tensioning strap for tensioner

Window frame

Tensioner

Hydraulic pump housing

Hydraulic unit with power cylinder

391_044

391_088

Acoustic and thermal insulation have been improved yet again by using insulating materials for the black inner headliner exclusive to the automatic convertible top.

The convertible top linkage for the fully automatic convertible top is completely covered by the black inner headliner in the drive motor area.

The rear window is heated and made of scratchproof mineral glass. It is larger than the predecessor's rear window and provides good all-round visibility when the convertible top is up.

Thanks to excellent thermal insulation and the heated glass rear window, the new Audi TT Roadster is absolutely winter-proof.

Electrical convertible top control system

Fitting locations of system components

On the next two pages you will find an overview of the system components.



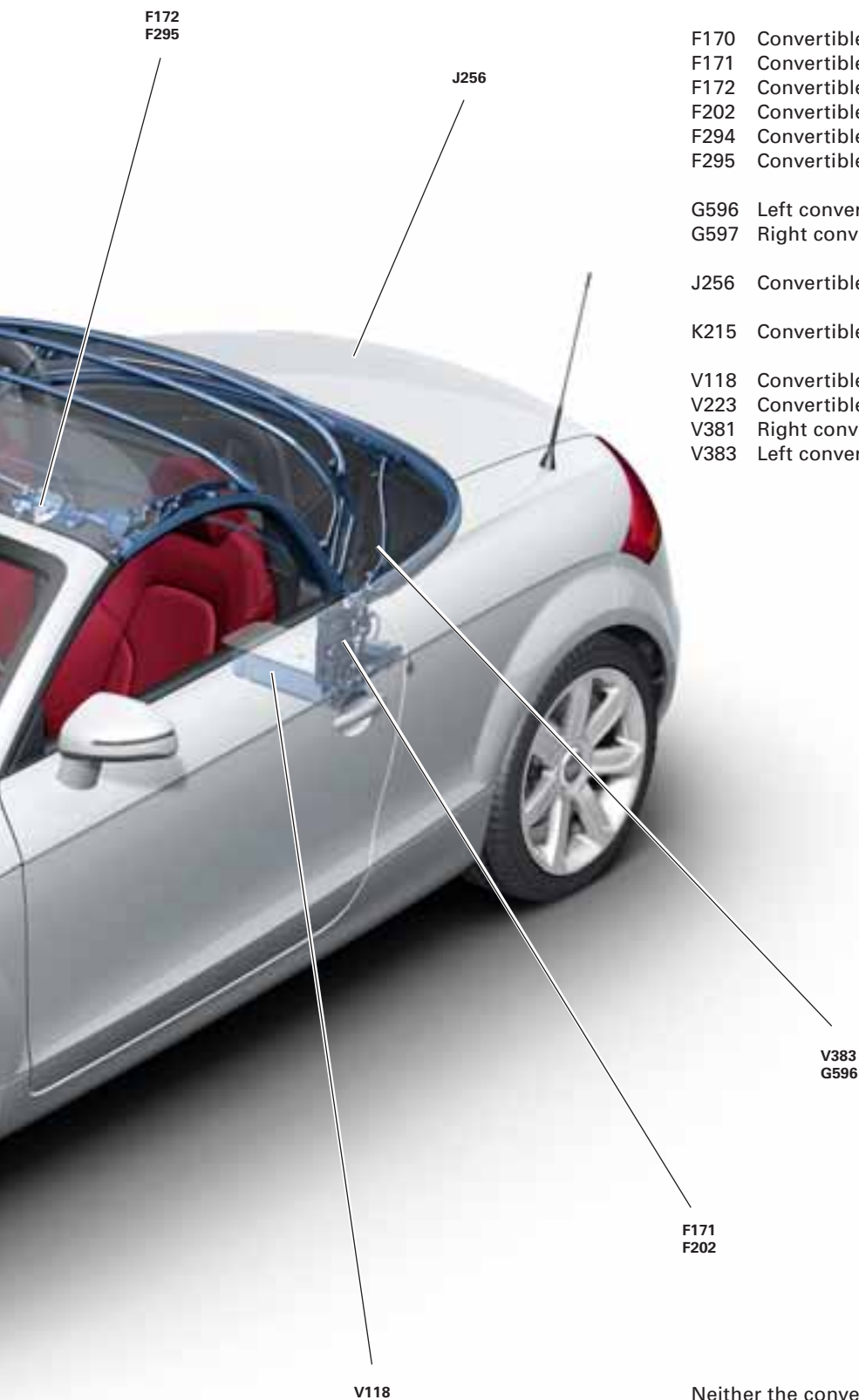

Legend:

- E137 Convertible top switch
- F170 Convertible top right latch switch
- F171 Convertible top stowed switch
- F172 Convertible top front latch switch
- F202 Convertible top front switch
- F294 Convertible top lock open switch
- F295 Convertible top lock closed switch (left/right)
- G596 Left convertible top cover sender
- G597 Right convertible top cover sender
- J256 Convertible top operation control unit
- K215 Convertible top operation warning lamp
- V118 Convertible top operation hydraulic pump
- V223 Convertible top lock motor
- V381 Right convertible top cover motor
- V383 Left convertible top cover motor

in whole, is not
 accepted any liability
 by AUDI AG.

391_085

Neither the convertible top cover motor V381 nor the convertible top cover sender G597 are shown here. Both components are fitted on the right-hand side of the vehicle, but are arranged identically on the left-hand side of the vehicle.

Electrical convertible top control system

Automatic convertible top operation

The convertible top of the Audi TT Roadster has an electro-hydraulic opening and closing mechanism. The convertible top can be actuated using the convertible top operating switch E137 or the driver's door lock cylinder.

In order to avoid damaging the convertible top and the rear window, all objects should be removed from the convertible top box before opening the top.

Convertible top opening (automatic)

Requirements:

- Vehicle stationary/speed < 50 kph
- Ignition "on"
- Ambient temperature > -15 °C
- Battery voltage OK

To start the convertible top opening cycle, pull the convertible top operating switch E137. The switch must remain pulled throughout the convertible top operating cycle. If the switch is released, the convertible top operating cycle will stop instantly. To restart the convertible top operating cycle (opening or closing), actuate (pull or push) the convertible top operating switch E137 again.

Convertible top operating switch E137



391_004

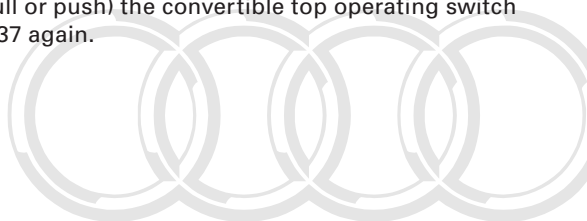

Audi

Protected by copyright. Copying for private or commercial purposes, in part or in whole, is not permitted unless authorised by AUDI AG. AUDI AG does not guarantee or accept any liability with respect to the correctness of information in this document. Copyright by AUDI AG

Convertible top opening and closing are indicated to the occupants by the convertible top operation warning lamp K215, which is incorporated in the control unit with display in the dash panel insert J285.

The warning lamp remains lit until the convertible top operating cycle is completed.

Convertible top operation warning lamp K215



391_005

During the opening cycle, the convertible top operation control unit J256 lowers the door glasses to a preset level, unlocks the convertible top lock and activates the convertible top operation warning lamp K215.

In addition to this, the onboard power supply control unit J519 deactivates the rear window defroster function.

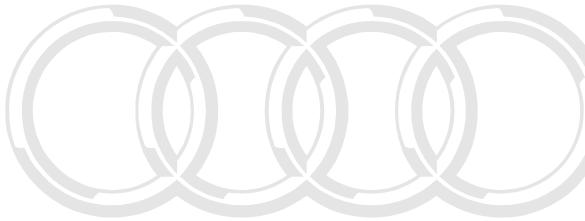

391_006

The convertible top operation control unit J256 then activates the convertible top operation hydraulic pump V118. The convertible top is opened. During the convertible top operating cycle, the engaging hooks of the convertible top locks located in the forward roof section are moved back into the "locked" position.

Protected by copyright. Copying for private or commercial purposes, in part or in full, is not permitted unless authorised by AUDI AG. AUDI AG does not guarantee or accept any liability with respect to the correctness of information in this document. Copyright by Audi AG.



391_007

After the convertible top has been stowed in the convertible top box, closing of the convertible top covers commences.

Once the convertible top covers are closed, the convertible top operation warning lamp K215 goes out.



391_008

If the convertible top operating switch is still being pulled after the convertible top covers are closed, the door glasses are closed again.



391_009

Electrical convertible top control system

Convertible top closing (automatic)

Requirements:

- Vehicle stationary/speed < 50 kph
- Ignition "on"
- Battery voltage OK

To start the convertible top closing cycle, push and hold down the convertible top operating switch. The closing cycle is performed in reverse order of opening. Once the door glasses have been lowered to the preset level, opening of the convertible top covers commences.

The convertible top operation warning lamp K215 informs the occupants that the convertible top operating cycle has been initiated.

The convertible top operation control unit J256 activates the convertible top operation hydraulic pump V118.

The convertible top is closed. The convertible top lock is opened during the convertible top operating cycle.

Once the front edge of the convertible top is resting on the windscreen frame, the convertible top lock is closed. The convertible top operation warning lamp K215 goes out.

The onboard power supply control unit is informed that the convertible top is closed.

The rear window defroster function is re-enabled.

If the convertible top operating switch is again pushed after closing the convertible top lock, the door glasses are closed again.



391_010



391_011



391_012



391_013

Protected by
patent law
with res

is not
any liability
AG.

Convenience opening/closing

The convertible top can also be operated via the locking cylinder in the driver's door.

To open the convertible top, the vehicle first has to be unlocked. Turn the lock cylinder towards the direction of travel using the ignition key.

To start the convertible top operating cycle, turn the ignition key again to the "open" position within two seconds and hold it engaged in this position.

To close the convertible top, lock the vehicle using the ignition key. Now turn the ignition key back to the "close" position within two seconds and hold it engaged in this position.

If the convertible top is in an intermediate position (neither closed nor open), the convertible top operating cycle can be started by actuating the lock cylinder once and holding the lock engaged.

If the vehicle has an anti-theft alarm, the vehicle must be opened with the remote control key before opening the convertible top. The anti-theft alarm is thereby deactivated. Please read and observe the information given in the vehicle's Owner's Manual.



391_014



391_015

Fully automatic convertible top operating cycle

The convertible top can be opened fully automatically while driving.

This function is active when the vehicle is travelling at a speed of > 6 kph and < 50 kph. To start the convertible top "opening" cycle, actuate the convertible top operating switch E137 briefly (for < 0.5 seconds).

If the convertible top "opening" cycle is started at a speed of < 50 kph and the vehicle is subsequently accelerated to a speed of > 50 kph, audible and visual warnings are issued to the driver while the convertible top is opening.

The convertible top "opening" cycle is not aborted.

Protected by copyright. Copying for private or commercial purposes, in part or in whole, is not permitted without the written permission of AUDI AG. AUDI AG is not liable for any errors or omissions with respect to the correctness of information in this document. Copyright by AUDI AG.

Unlike the fully automatic opening cycle, the convertible top can only close automatically.

This means: the convertible top operating switch E137 must be kept pressed down throughout the convertible top operating cycle.

If the vehicle exceeds a speed of 50 kph, the automatic convertible top closing cycle is aborted. The convertible top stops instantly, whatever its position at that moment.

Audible and visual warnings are issued to the driver. If the vehicle is travelling at a speed of less than 50 kph, the driver has to restart the convertible top closing cycle by actuating the convertible top operating switch.



391_062

Electrical convertible top control system

Emergency release

If the convertible top cannot be operated because of a malfunction, it is possible to close and open the convertible top manually.

Closing the convertible top

Requirements:

- Handbrake applied
- Door glasses lowered
- Ignition "off"
- Ignition key removed

Firstly, the hydraulic system must be depressurised. Using a screwdriver, turn the emergency release screw on the hydraulic unit approx. one half turn anticlockwise.

If the convertible top has been closed or opened manually, the emergency release screw must be closed again.



391_081



391_082

Protected by copyright. Copying for private or commercial purposes, in part or in whole, is not permitted unless authorised by AUDI AG. AUDI AG does not guarantee or accept any liability with respect to the correctness of information in this document. Copyright by AUDI AG.

The convertible top covers can be raised after disengaging the actuating rods between the left and right convertible top cover motors.

The convertible top can now be lifted out of the storage box and locked in place on the windscreen frame.

This work should be done by two persons. Do not reach into the linkage when closing the convertible top.



391_074



391_060

At the centre of the convertible top at the front there is a blanking cap which can be removed using a screwdriver.



391_078

In the spline shaft beneath, screw in the crank, threaded end first, until fully home. The spline shaft acts as the driving shaft between the convertible top lock motor V223 and the linkage of the convertible top locks.

Pull out the spline shaft downwards using the crank.

In place of the spline shaft, insert the crank, spline head first, as far as it will go. To open the convertible top lock, turn the crank clockwise.

Now press the convertible top down onto the windscreen frame by hand. To close and fully lock the convertible top lock, turn the crank anticlockwise.

Now insert the spline shaft until fully home and unscrew the crank by turning it anticlockwise.



Spline head

391_079

Spline shaft



391_080

The convertible top is opened in the reverse order of closing.

A complete automatic convertible top operating cycle (opening and closing) must be performed as a function test after all emergency operation and troubleshooting procedures.

The tools required for emergency operation are included in the car tool kit.

Note



For further information on emergency operation and operation of the convertible top, please refer to the vehicle's Owner's Manual.

Electrical convertible top control system

Components of the convertible top control system

The central element of the convertible top control system in the Audi TT Roadster is the convertible top operation control unit J256.

It controls and monitors the automatic convertible top operating cycle and is responsible for diagnostics.

If the diagnostics detect faulty components or if the signals from the individual components involved in the convertible top operating cycle fail are not received in time, the convertible top operating cycle is stopped.

Convertible top operating switch E137

To start the convertible top operating cycle, push or pull the convertible top operating switch E137.

- Push: the open convertible top is closed
- Pull: the closed convertible top is opened

If the switch is released during the convertible top operating cycle, the convertible top stops moving immediately.

To resume convertible top operation in any direction, actuate the switch again.

If the vehicle is travelling at a speed of between 6 and 50 kph, a short pull (< 0.5 seconds) of the convertible top operating switch is sufficient to start fully automatic opening of the convertible top. If the vehicle is travelling at faster than 50 kph, it is no longer possible to start the convertible top operating cycle.

The convertible top operating switch is located on the vehicle's centre console.

Convertible top operating switch E137



391_004

Convertible top front latch switch F172

The convertible top front latch switch F172 is integrated in the lock bottom part on the left-hand side of the windscreen frame.

The engaging hook of the left lock top part actuates the switch by means of a rocker.

The convertible top operation control unit J256 recognises from the position of the switch whether the convertible top lock is "closed" or "open".

Engaging hook
Rocker
Convertible top front latch switch F172



391_051

Convertible top right latch switch F170

The convertible top right latch switch F170 can be found in the lock bottom part on the right windscreen frame.

The engaging hook of right lock top part actuates the switch by means of a rocker.

The convertible top operation control unit J256 determines from the position of the switch whether the convertible top lock is "closed" or "open".

The convertible top front latch switch F172 and the convertible top right latch switch F170 are connected in series.

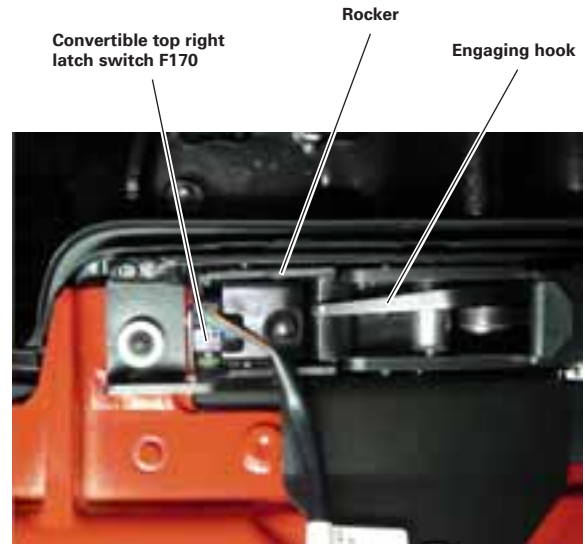

391_050



Convertible top stowed switch F171

The signal from the convertible top stowed switch F171 informs the convertible top operation control unit J256 whether the convertible top is stowed in the convertible top box or not.

The convertible top stowed switch F171 is a Hall sensor. The sensor is located on the left main bearing of the convertible top mechanism. When the convertible top is stowed in the convertible top box, a metal arm of the convertible top mechanism is positioned directly opposite the Hall sensor. The convertible top operation control unit J256 monitors the power supply of the Hall sensor. If the control unit measures a voltage of approx. 9 volts, then the convertible top is stowed in the convertible top box.

If the voltage drops to approx. 3.5 volts, the convertible top operation control unit J256 recognises that the convertible top is no longer stowed in the convertible top box.

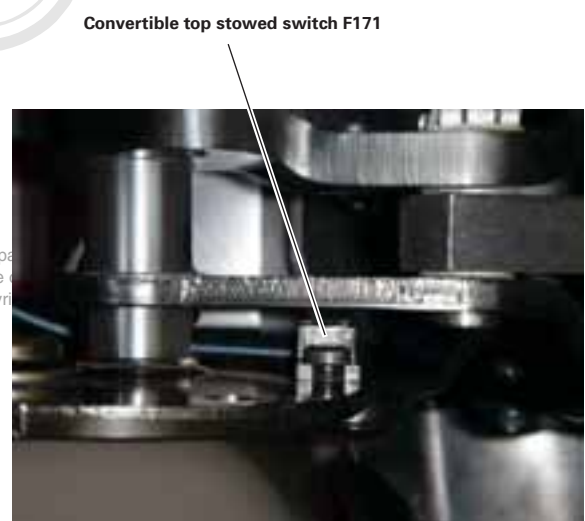

391_052

Electrical convertible top control system

Convertible top front switch F202

Like the convertible top stowed switch F171, the convertible top front switch F202 is a Hall sensor. This switch is also located on the left main bearing of the convertible top.

The convertible top operation control unit J256 monitors the power supply of the Hall sensor. If the control unit measures a voltage of approx. 9 volts, the convertible top is closed.

If the voltage drops to approx. 3.5 volts, the convertible top operation control unit J256 concludes that the convertible top is no longer closed.

Convertible top front switch F202

Metal arm



391_053



Convertible top lock closed switch F295

The convertible top lock closed switch F295 is located on the left and right lock top parts installed in the forward roof section (tip of the roof).

The signals the convertible top operation control unit J256 receives from the switches inform the former whether the locks are closed or not.

This information is used, among other things, for opening and closing the locks parallel to the convertible top operating cycle.

The two convertible top lock closed switches F295 are connected in series.

Convertible top lock closed switch F295
Left lock top part

Actuating linkage of convertible
top lock motor V223



391_057

Actuating linkage
of convertible top lock
motor V223



Convertible top lock
closed switch F295
Right lock top part

391_056

Convertible top lock open switch F294

Switch F294 is also mounted to the bracket to which the convertible top lock motor V223 is attached. The convertible top lock open switch F294 is actuated by the convertible top lock linkage. In this way, the convertible top operation control unit J256 is always informed when the convertible top lock motor V223 is in the "open" position.

Convertible top lock open switch F294

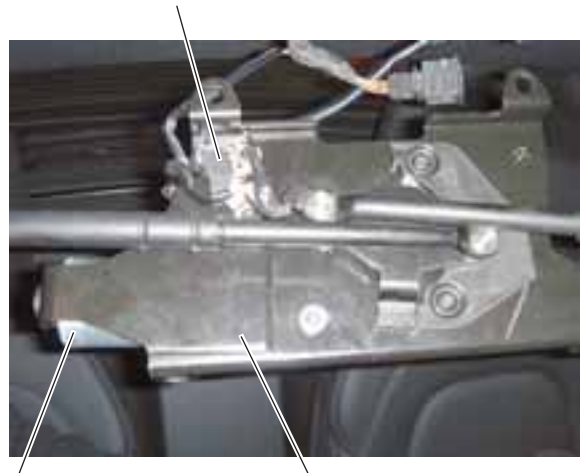

Convertible top lock motor V223

Bracket removed

391_055

Left convertible top cover sender G596 Right convertible top cover sender G597

The convertible top covers are located on the left and right-hand sides of the convertible top box and cover the main bearings of the convertible top mechanism when the convertible top is open. The convertible top covers are driven by the convertible top cover motors V381 and V383. Potentiometers G596 and G597 are integrated in the convertible top cover motors to inform the convertible top operation control unit J256 about the actual position of the convertible top covers.



Convertible top cover motor V383
with convertible top cover sender G596

391_059

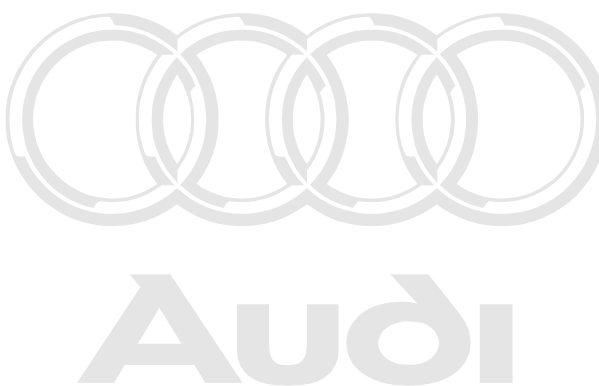

391_074

Protected by copyright. Copying for private or commercial purposes, in part or in whole, is not permitted unless authorised by AUDI AG. AUDI AG does not guarantee or accept any liability with respect to the correctness of information in this document. Copyright by AUDI AG.

Note



After repair work on the convertible top covers, convertible top cover senders G596 and G597 must be adapted to the convertible top operation control unit J256. This can only be accomplished using a VAS tester and the Guided Fault Finding or Guided Functions option.

Electrical convertible top control system

Convertible top operation control unit J256

Automatic or fully automatic convertible top operation is only possible using the convertible top operation control unit J256.

The convertible top operation control unit J256 gathers information from the sensors, evaluates this and activates the actuators.

The convertible top operation control unit J256 is also responsible for system diagnostics.

If a faulty actuator or a sensor is identified or if the signals from the sensors are not received in time, the control unit stops the convertible top operating cycle. A fault is stored in the fault memory.

In addition, the control unit monitors the operating time of the convertible top. In order to avoid overloading the hydraulic pump, the convertible top operation control unit J256 deactivates the convertible top after approx. three minutes, provided that the convertible top is closed.

The convertible top can be operated again until a time-out of approx. ten minutes has expired. If the convertible top does not meet the "closed" condition after approx. four minutes of continuous operation, the control unit stops the convertible top operating cycle immediately. The convertible top cannot be operated again until a 20 minute time-out has expired. The actuation time of the convertible top lock motor is also used for monitoring the operating time of the convertible top.

The convertible top operation control unit J256 is integrated in the convenience CAN bus and exchanges data with other vehicle systems across this bus.

The control unit is housed in the luggage compartment under the cargo floor.

Convertible top operation control unit J256



Convertible top operation hydraulic pump V118

The automatic convertible top is operated by a hydraulic mechanism.

The convertible top operation control unit J256 activates the convertible top operation hydraulic pump V118.

Oil flows along the hose to the two hydraulic cylinders.

The convertible top is opened or closed, depending on the direction of rotation of the pump.

The hydraulic system is self-locking. The pressure which is generated is retained in the system even after the ignition has been turned off.

The hydraulic pump is housed in the luggage compartment behind the driver's seat.



391_045

Protected by copyright. Copying for private or commercial purposes, in part or in whole, is not permitted unless authorised by AUDI AG. AUDI AG does not guarantee or accept any liability with respect to the correctness of information in this document. Copyright by AUDI AG.

Convertible top lock motor V223

The convertible top lock motor V223 actuates, by means of a linkage, the two engaging hooks in the lock top parts fitted in the forward section of the roof.



Convertible top lock motor V223

391_058

Electrical convertible top control system

Right convertible top cover motor V381 Left convertible top cover motor V383

The left and right convertible top covers are opened and closed by the two convertible top cover motors V381 and V383. The convertible top covers are held in the open or closed position by the motors.

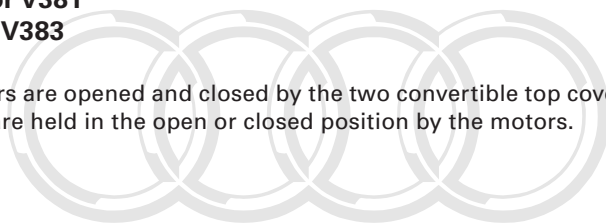

Audi

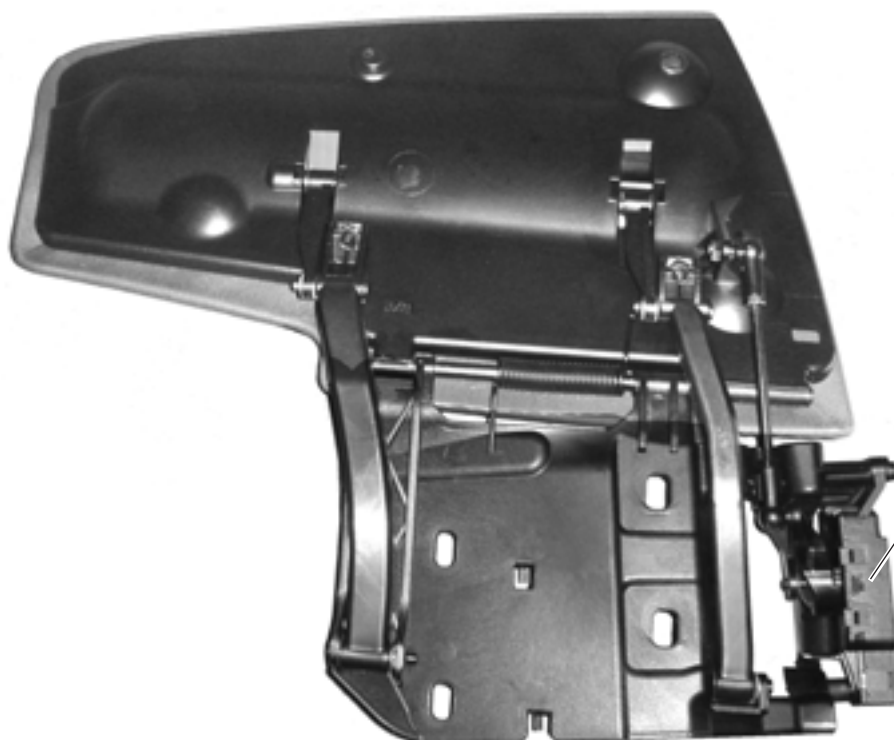

t or in whole, is not
accept any liability
ht by AUDI AG.

Convertible top cover motor

391_061



Convertible top cover motor

391_059

Convertible top operation warning lamp K215

Convertible top operation warning lamp K215

The convertible top operation warning lamp K215 is located in the dash panel insert and is activated by the control unit with display in dash panel insert J285.

After the ignition is turned on, the convertible top operation warning lamp K215 comes on for approx. two seconds and goes off again, this being a function test.

The warning lamp also has the following functions:

- It comes on when the automatic convertible top is opening and closing.
- It begins to flash when one of the conditions for automatic opening or closing of the convertible top is not met and the convertible top operation switch is actuated.
- It comes on when the convertible top is not fully open or closed.



Protected by copyright. Copying for private or commercial purposes, in part or in whole, is not permitted unless authorised by AUDI AG. AUDI AG does not guarantee or accept any liability for the correctness of information in this document. Copyright by AUDI AG.

391_005

Control unit with display in dash panel insert J285

Data exchange between the convertible top operation control unit J256 and the control unit with display in dash panel insert J285 takes place across the CAN data bus.

Based on the information received from the convertible top operation control unit J256, the control unit with display in dash panel insert J285 activates the convertible top operation warning lamp K215, the signal generator in the dash panel insert and/or displays a message text to this effect via the centre display.



391_072

Electrical convertible top control system

System overview

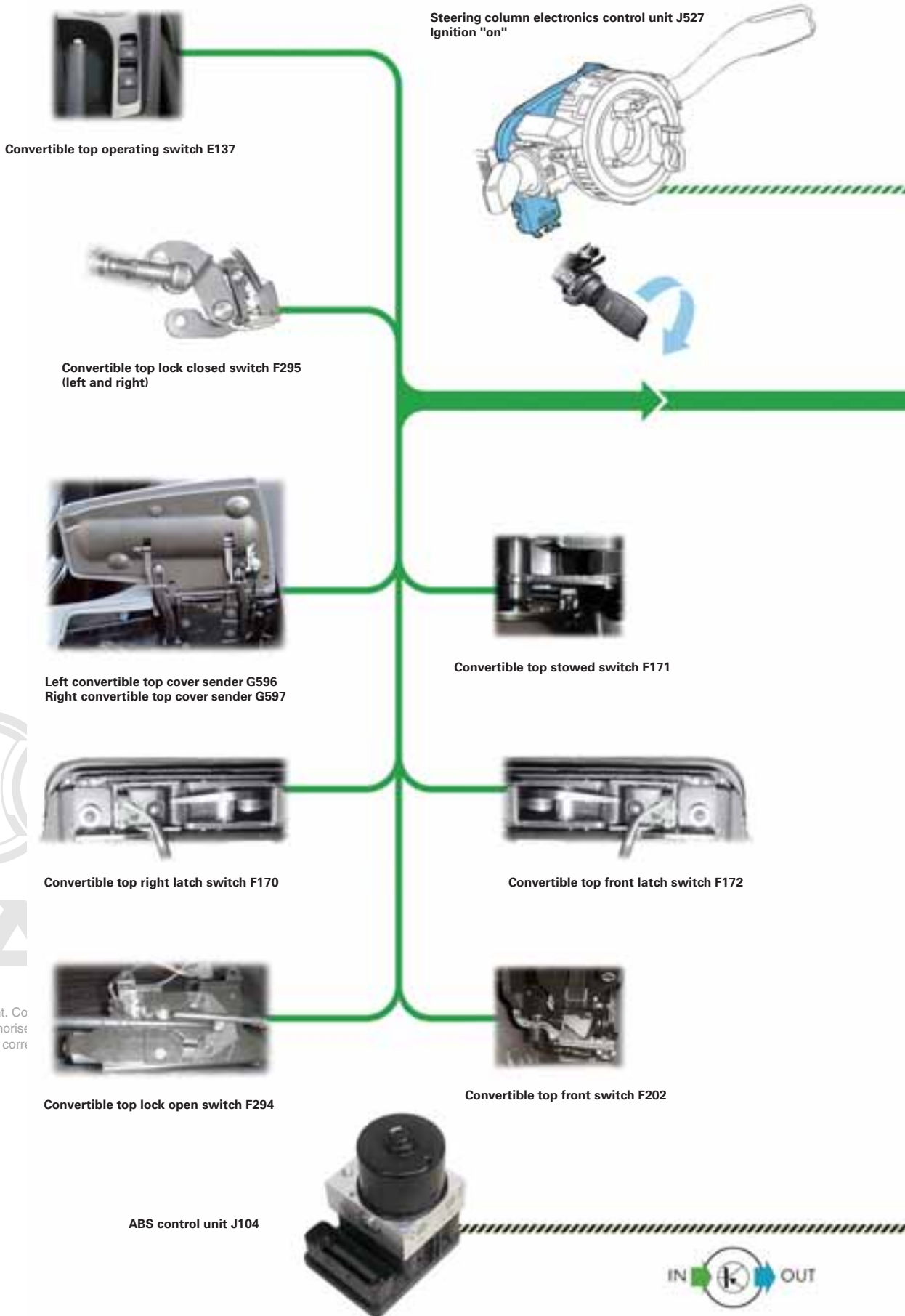

Protected by copyright. Co
permitted unless authorise
with respect to the corr

Control unit with display in dash panel insert
J285



Convertible top operation warning lamp
K215



Centre display
Dash panel insert



Convertible top operation control unit J256



Diagnostic port

Convenience system
central control unit J393



Convertible top convenience opening/closing

Onboard power supply control unit J519



Convertible top operation
hydraulic pump V118



Convertible top cover motor V381/V383

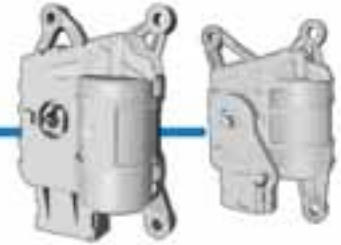

Convertible top lock motor V223



Door control units J386/J387



Heated rear window Z1

Electrical convertible top control system

Topology and networking

On the next two pages you will find an overview of the networking of the individual control units in the Audi TT Roadster. The convertible top operation control unit J256 is integrated in the convenience CAN bus.

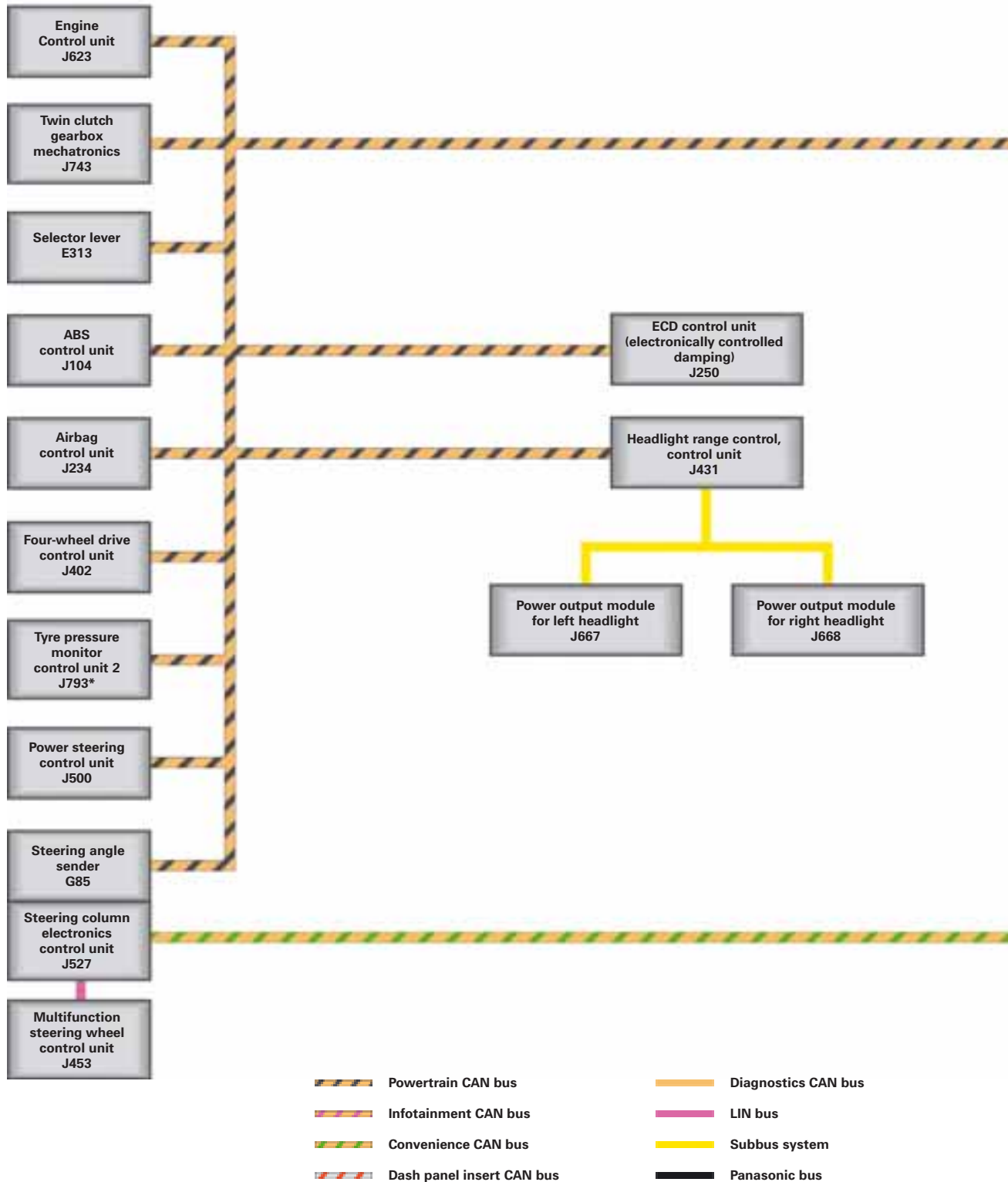

Diagnosis connection



Control unit with display in dash panel insert
J285

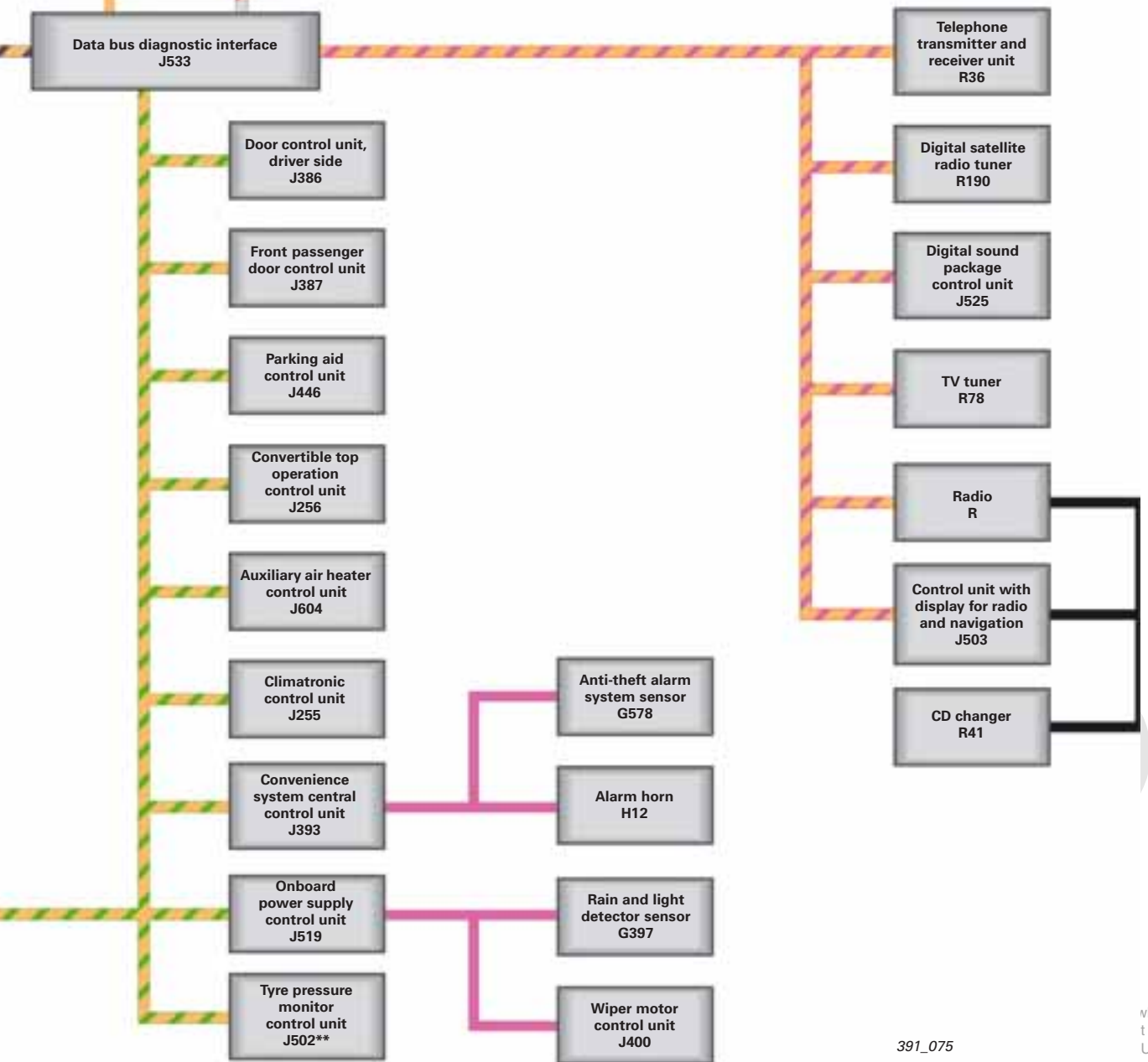

* for tyre pressure monitoring system 2 only (ECE = Europe)
** for tyre pressure monitor only (SAE = North America)

391_075

whole, is
t any lia
UDI AG

Electrical convertible top control system

Data exchange

To ensure smooth operation of the convertible top, the convertible top operation control unit J256 requires various information.

In addition to the information received from the system's sensors, the control unit requires information from other automotive systems, e.g. ESP.

Other control units are also dependent on the information supplied by the convertible top operation control unit. This information is exchanged across the CAN data bus.

The convertible top operation control unit is integrated in the convenience CAN bus and sends and receives data across this CAN bus.

Convertible top operation control unit J256



391_054

Protected by copyright. Copying for private or commercial purposes, in part or in whole, is not permitted unless authorised by AUDI AG. AUDI AG does not guarantee or accept any liability with respect to the correctness of information in this document. Copyright by AUDI AG.

Data exchange between the individual CAN data bus systems is effected via the data bus diagnostic interface J533.

There is an intensive and continuous exchange of data between the individual automotive systems.

The data bus diagnostic interface is located below the dash panel adjacent the pedal bracket. The control unit is accessible from the driver footwell.

Data bus diagnostic interface J533



391_076

Reference

For information on the CAN data bus, refer to Self-Study Programme 238 "Data exchange across CAN data bus I" and 269 "Data exchange across CAN data bus II".



CAN data bus interfaces

The overview shows by way of example the information exchanged across the CAN data bus. The individual control units send or receive data required for smooth operation of the convertible top.

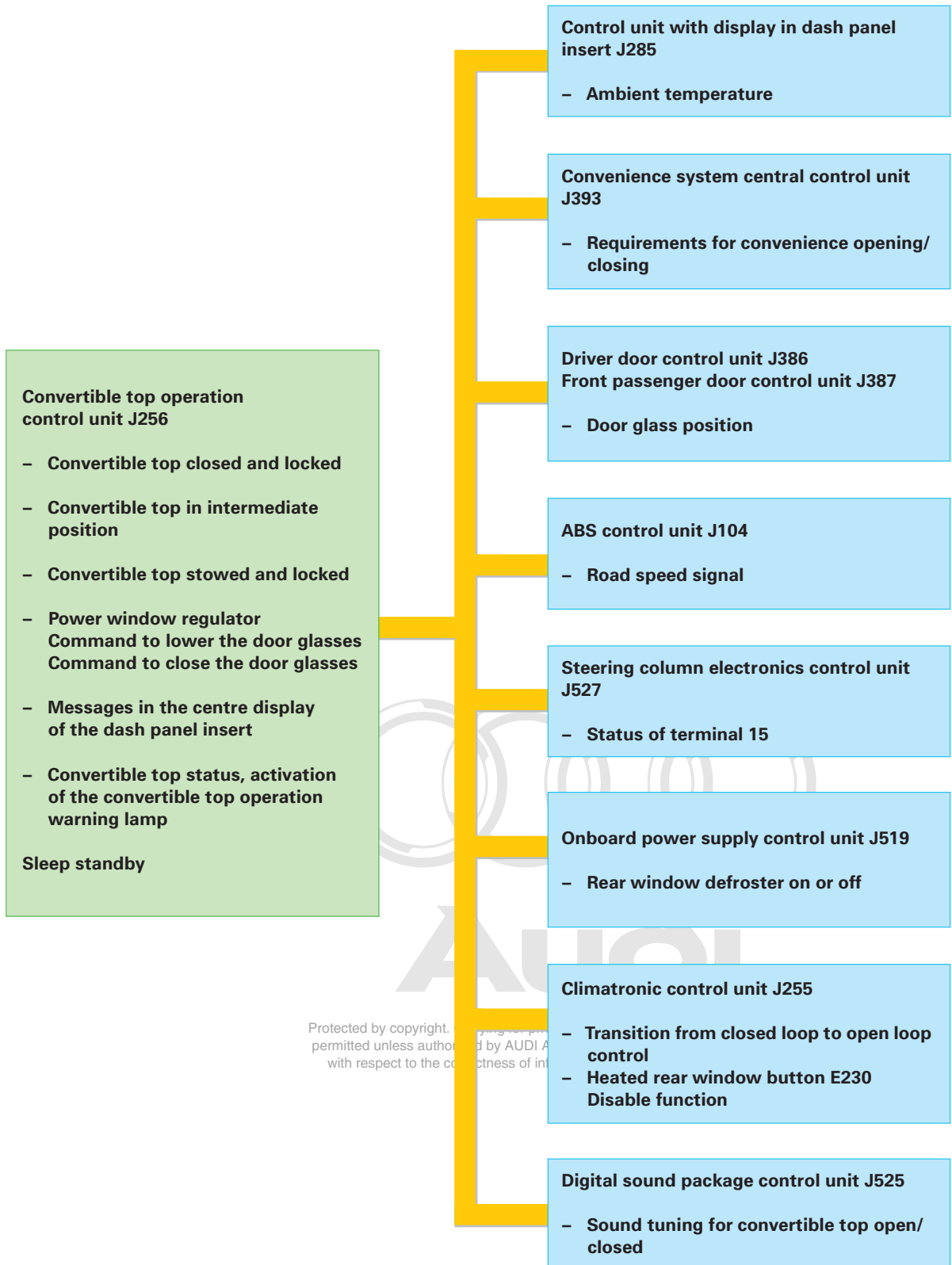

Protected by copyright. All rights reserved. No part of this publication may be reproduced, stored in a retrieval system, or transmitted, in any form or by any means, electronic, mechanical, photocopying, recording, or otherwise, without the prior written permission of Audi AG. Audi AG is not liable for any errors or omissions in this publication with respect to the correctness of information.

Electrical convertible top control system

Function diagram

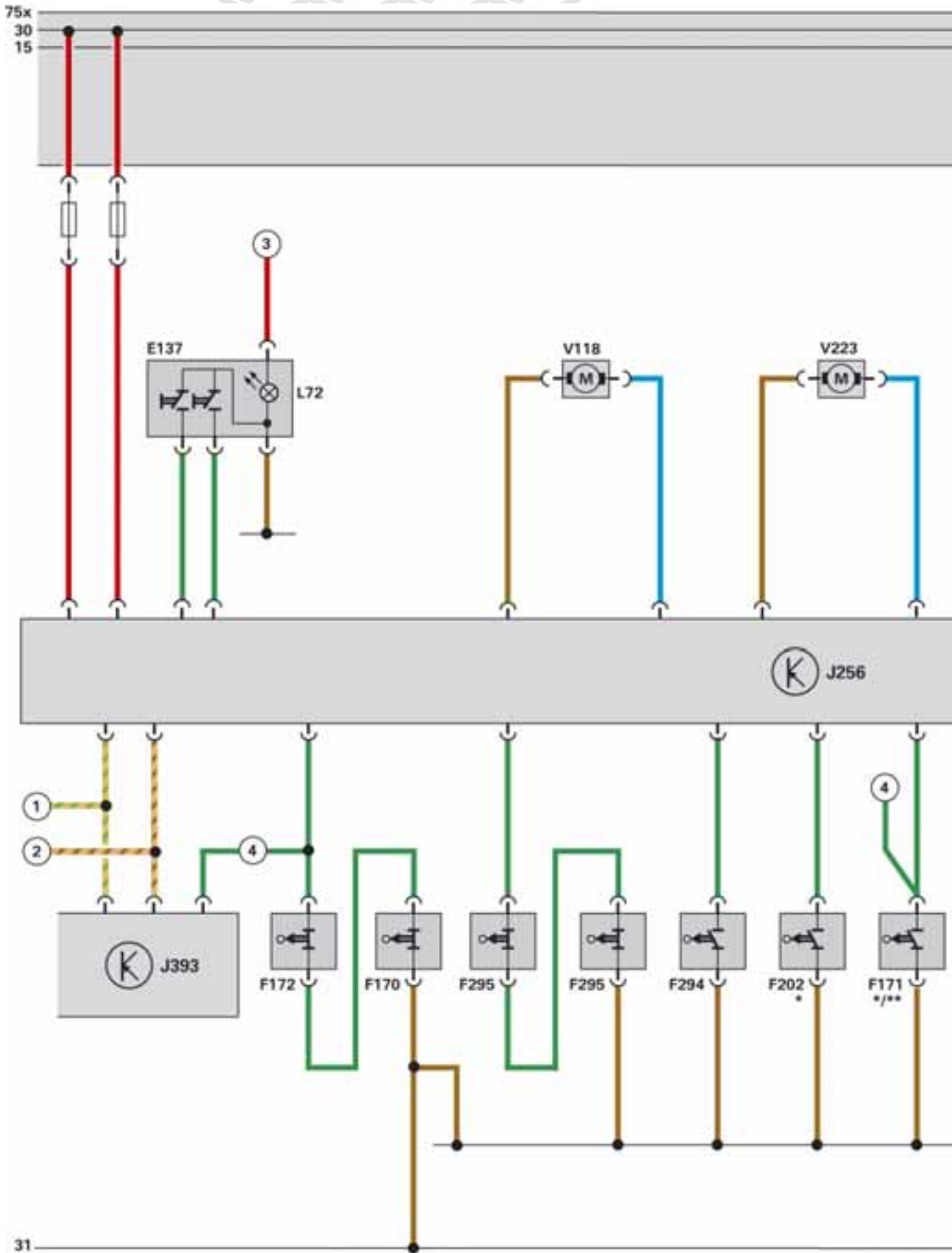

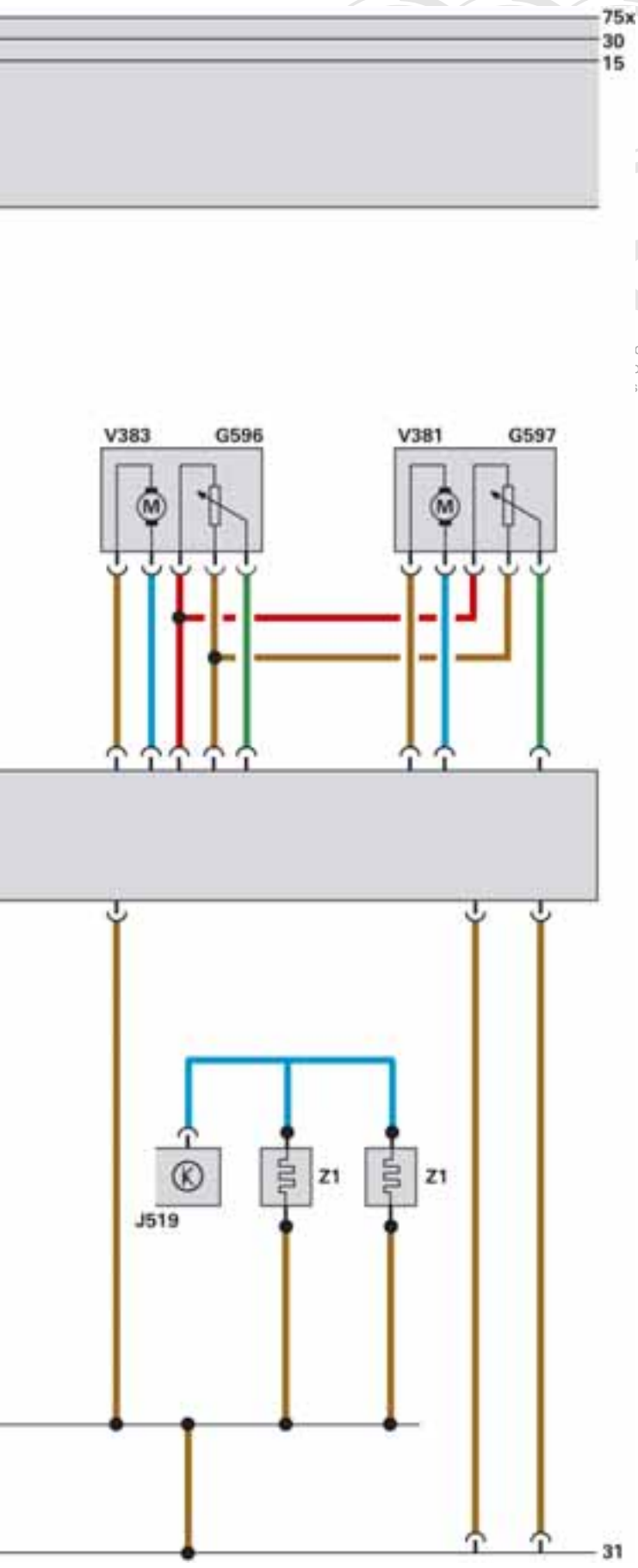

Legend:

- E137 Convertible top switch
- F170 Convertible top right latch switch
- F171 Convertible top stowed switch
- F172 Convertible top front latch switch
- F202 Convertible top front switch
- F294 Convertible top lock open switch
- F295 2x convertible top lock closed switch (left/right)
- G596 Left convertible top cover sender
- G597 Right convertible top cover sender
- J256 Convertible top operation control unit
- J393 Convenience system central control unit
- J519 Onboard power supply control unit
- L72 Convertible top operating switch illumination
- V118 Convertible top operation hydraulic pump
- V223 Convertible top lock motor
- V381 Right convertible top cover motor
- V383 Left convertible top cover motor
- Z1 Heated rear window

- ① Convenience CAN bus (high)
- ② Convenience CAN bus (low)
- ③ Terminal 58s
- ④ to J393 (manual convertible top only)

* Hall sensors are used with the automatic convertible top

** a microswitch is used with the manual convertible top

Hydraulic system

Convertible top opening cycle

The hydraulic system comprises an electric motor, a pump housing and the oil tank which are connected to the hydraulic cylinders by plastic sheathed lines. The convertible top is opened or closed by reversing the direction of rotation of the electric motor. When the convertible top switch is actuated, the hydraulic pump turns clockwise. The two-way valve closes the return line on the pressure side and simultaneously opens the pressureless return line on the opposite side. A slight excess pressure is applied to the check valve by increasing the pressure. The hydraulic pressure flows into the hydraulic cylinder above the piston rod and pushes it down, opening the convertible top.

At the same time, pilot pressure is applied to the pressure-controlled check valve on the pressureless side through a bypass port from the pressure side.

This causes the pressure relief valve to open and the hydraulic fluid displaced backwards by the cylinder flows to the pump or back into the oil pan.

If the dead centre position of the convertible top kinematics is exceeded, restrictor orifices create a backpressure which prevents the convertible top from lowering too quickly.

If the convertible top switch is still being actuated when the convertible top reaches its end position, the hydraulic pressure continues rising to a maximum of approx. 160 bar. A spring loaded valve opens and the excess hydraulic pressure flows back into the oil tank.

When the convertible top switch is released, the check valve closes and a residual pressure in the cylinder stabilises the convertible top linkage while driving.

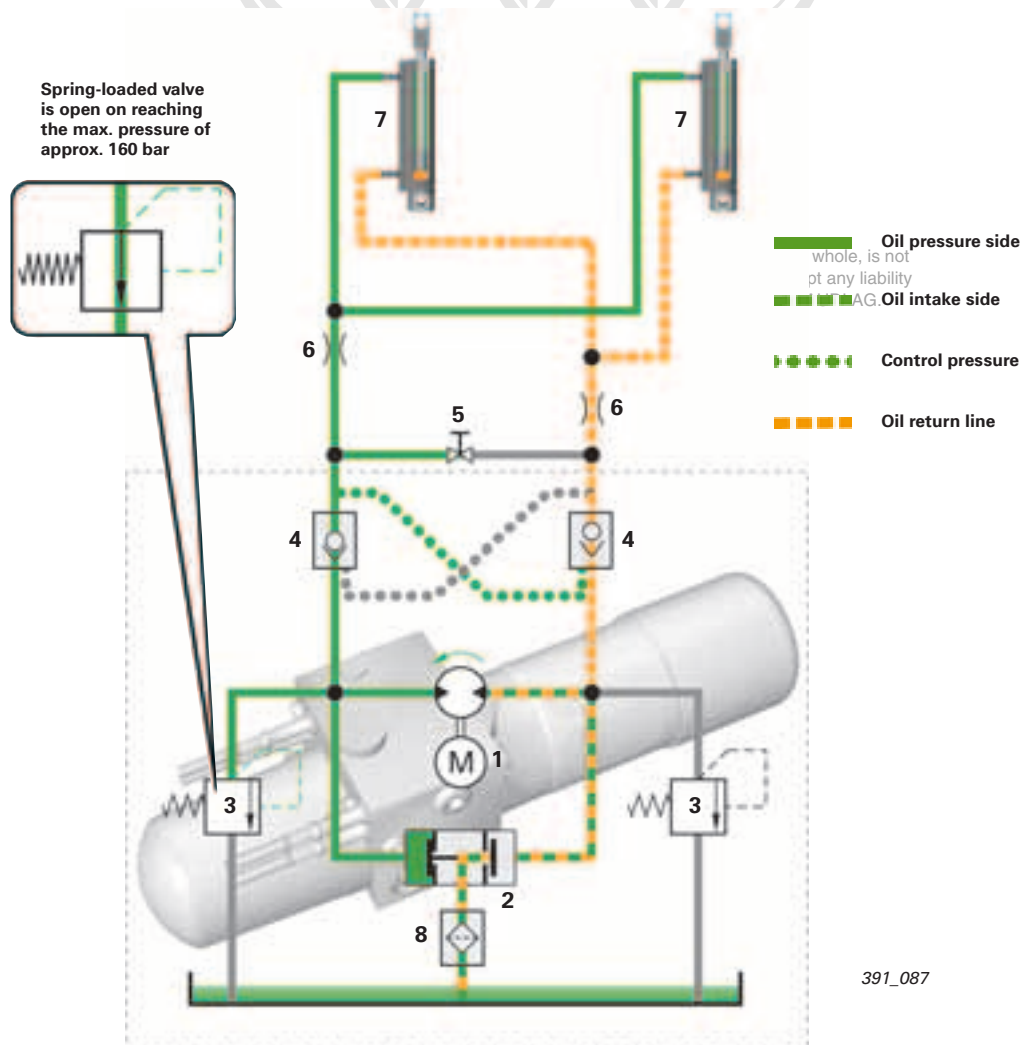

Legend:

- | | | | |
|---|-------------------------------------|---|----------------------------------|
| 1 | Electric motor with hydraulic pump | 5 | Emergency release |
| 2 | Two-way valve | 6 | Return flow restrictors |
| 3 | Spring-loaded pressure relief valve | 7 | Hydraulic cylinder |
| 4 | Pressure-controlled check valve | 8 | Oil filter in the hydraulic pump |

Convertible top closing cycle

When closing the convertible top, the hydraulic pump turns anticlockwise and the two-way valve now closes on the opposite side. The hydraulic pressure flows through the check valve to the hydraulic cylinder beneath the piston rod and pushes the piston rod upwards, closing the convertible top.

At the same time, pilot pressure is applied to the pressure-controlled check valve on the pressureless side through a bypass port from the pressure side.

If the convertible top switch is still being actuated when the convertible top reaches its end position, the hydraulic pressure continues rising to a maximum of approx. 160 bar.

A spring loaded valve opens and the excess hydraulic pressure flows back into the oil tank.

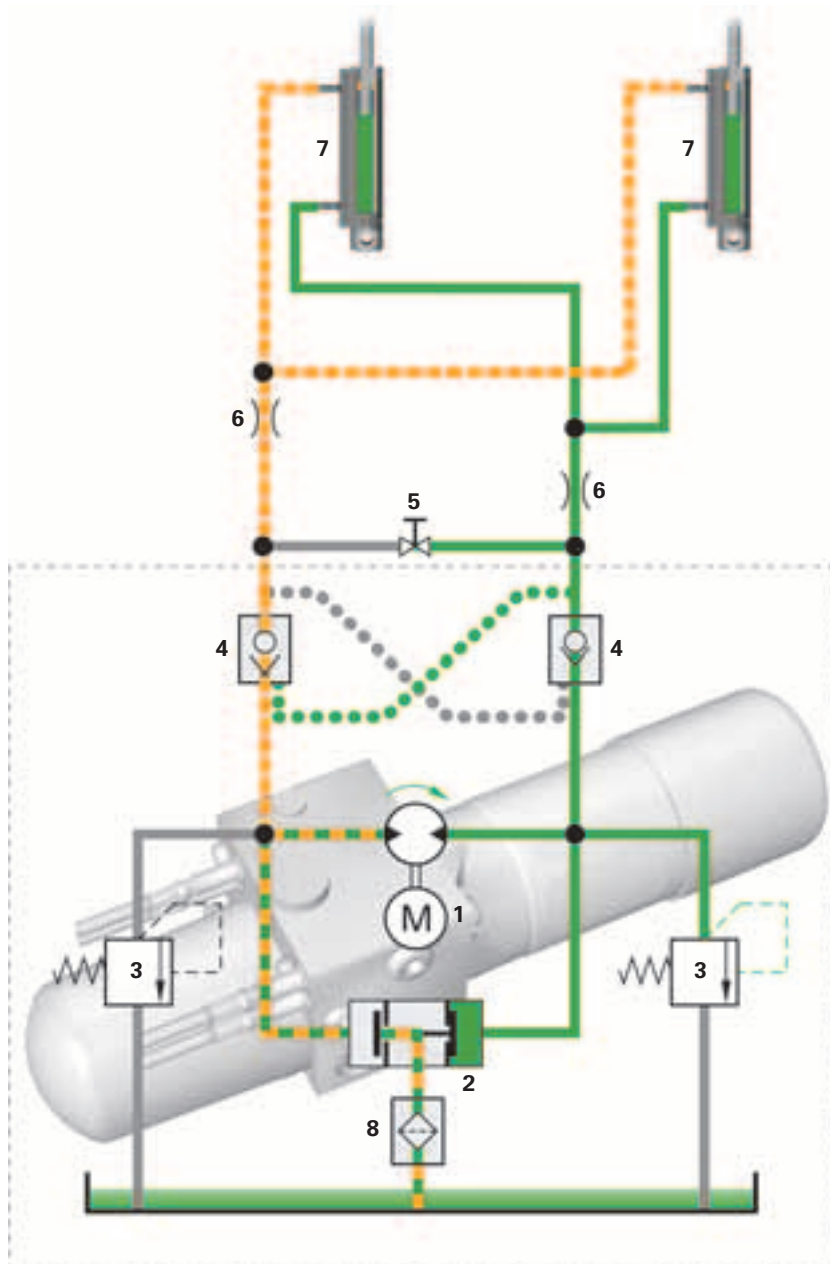

391_086



Convenience electronics

Windbreak

A windbreak is available as optional equipment for the Audi TT Roadster. The windbreak is located between the two roll bars and the convertible top box and can be raised and lowered electrically. Its task is to reduce air movement inside the occupant cell in order to enhance driving comfort.



391_066

Operating the windbreak

The windbreak can be raised and lowered by the driver using the windbreak operation switch. Switch E278 is located in the centre console below the convertible top operating switch E137. The switch must remain actuated throughout the windbreak lowering and raising cycle. An automatic cycle is not available for this function.



391_004

Windbreak switch, Cabrio E278

Electrical function

The "electrical windbreak operation" function is implemented by an illuminated button with two relays and a DC motor. The button can be moved into the "Up" and "Down" positions by the driver. Depending on operation, the button closes one of the two control current circuits of the relays, which thereupon close the load circuit and energise windbreak motor, Cabrio V186.

The two relays are mounted on a relay carrier above the onboard power supply control unit, which is located in the footwell at the front left. They can be replaced separately.

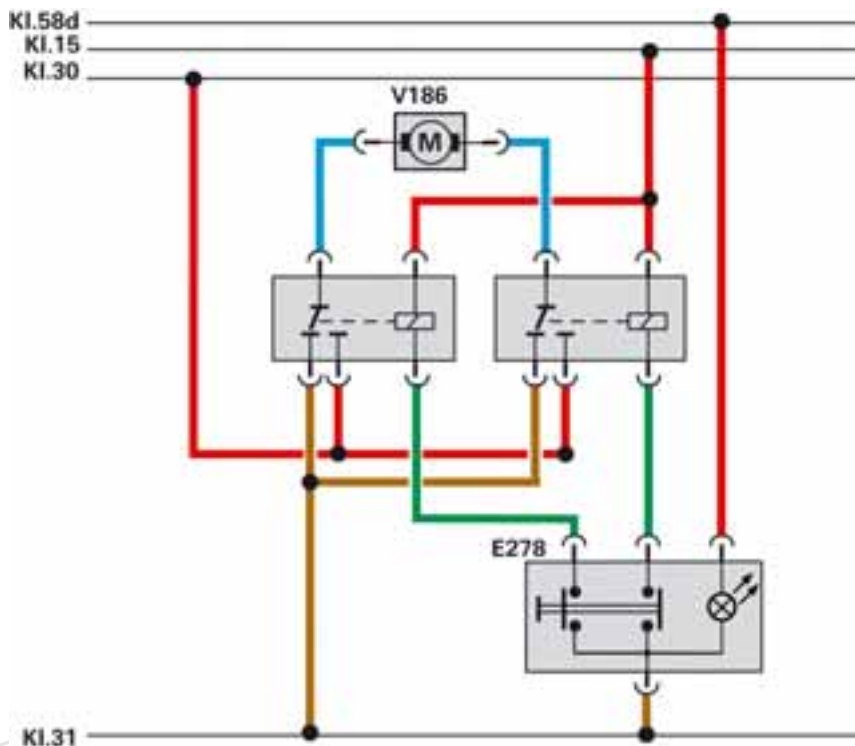

391_068

Legend:

E278 Windbreak switch, Cabrio
V186 Windbreak motor, Cabrio

Audi

Protected by copyright. Copying for private or commercial purposes, in part or in whole, is permitted unless authorised by AUDI AG. AUDI AG does not guarantee or accept any liability with respect to the correctness of information in this document. Copyright by AUDI AG.

Note



Diagnostics:

There is no control unit between the sensor and actuator (DC motor). This task is performed by two relays. No diagnosis is given for this reason. Hence, no entries are made in the fault memory in the event of a fault.

Consequently, no data blocks, adaptations, codings or final control diagnostics are available for this function in the diagnostic tester.

Suspension system

Overview

The running gear is basically identical to that of the Audi TT Coupé, except for the modifications shown.

Front and rear axle damper set-ups
for front-wheel drive and quattro drive

Set-up of suspension strut bearing
for front-wheel drive and quattro drive



391_030

Front and rear axle suspension set-ups
for quattro four-wheel drive

Steel axle carrier for quattro four-wheel drive,
to be introduced in the Roadster and in the TT Coupé

Axle carrier for front-wheel drive
Part adopted from VW EOS, rigidly bolted

Rear suspension



Rear axle for front-wheel drive

For information purposes, in part or in whole, is not a guarantee or accept any liability for the information. Copyright by AUDI AG.

391_024



Rear axle for quattro four-wheel drive

391_040

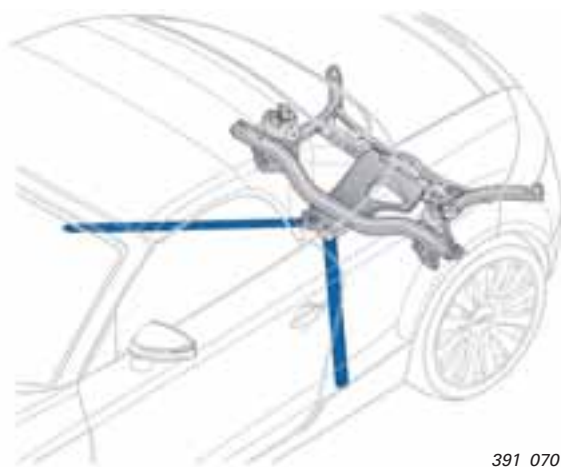

Attachment of the diagonal struts for front-wheel drive



Attachment of the diagonal struts for quattro four-wheel drive

To increase vehicle rigidity, additional diagonal struts are fitted in the rear section of the Audi TT Roadster. The struts connect the rear axle carriers to the body through additional mounting points. The threaded couplings on the axle carriers are different for front-wheel drive or quattro drive.

Heating and air conditioning system

Heating system

The entry-level engines of the Audi TT Roadster are equipped as standard with a heating and ventilation system.

Heater control unit, Climatronic control unit J255, differs from the control unit with air conditioning system in regard to its design.

The rotary temperature control has neither degrees nor units of temperature.

The designations of the Climatronic control unit J255 of the heating system and the air conditioning system in the Audi TT Coupé '07 and Audi TT Roadster are identical.

The name has been adapted and the heating system is now:

Heating control unit, Climatronic control unit J255. Of course, both air conditioner control units have different part numbers.

Seat heating is likewise an optional extra in the Audi TT Roadster.

Three heater settings can be selected at the touch of a button. The selected heat output setting is indicated by LEDs above the button.

Heating control unit, Climatronic control unit J255

Rotary control "Temperature"

Rotary control "Air flow"

Rotary control "Air distribution"



Function key "Air recirculation"

Seat heating button with LEDs

in whole, is not permitted unless authorised by AUDI AG. AUDI AG does not guarantee or accept any liability with respect to the correctness of information in this document. Copyright by AUDI AG.

391_016

Vehicles equipped with a heating system only are not fitted with various components which are required for temperature control in vehicles equipped with an air conditioning system.

Vehicles equipped with a with heating system only do not, for example, have the temperature flap control motor, right V159, the front left chest vent temperature sender G385, the vent temperature sender, left and right footwells G261, G262, the evaporator out-flow temperature sender G263, the dash panel temperature sensor G56 and its temperature sensor blower V42, the sunlight penetration photo sensor G107, the high pressure sender and, finally, the air conditioner compressor.

The heating system and the air distribution housing differ from one another in that certain components are not present heating systems, as compared to air conditioning systems.

Refer to the Workshop Manual for further information.

The heating control unit, Climatronic control unit J255, can only send the fan(s) on command to the engine control unit in the final control diagnostics function.

When the engine is running, the engine control unit activates the radiator fan(s) directly or via the radiator fan control unit J293.

In Audi TT Roadster vehicles which are equipped with a heating system only, the two radiator fans (number of fans depends on engine specification) are not controlled by the heating control unit, Climatronic control unit J255.

Radiator fan V7 with radiator fan control unit J293



391_017

Audi

Water drains

The two water drains in the plenum chamber are located on the outer left and right sides of the plenum chamber. The condensation drain hose of the air conditioning system is not required.

The port on the centre tunnel of the body must be sealed with a plug in vehicles equipped with a heating system only.

Ambient temperature sensor G17

In the heating system, ambient temperature sensor G17 serves only to calculate the "on" time of the heated rear window Z1.

Interior monitor

Anti-theft alarm system

The TT Roadster '07 has adopted the anti-theft alarm sensor G578 from the TT Coupé '07. This sensor incorporates both the interior monitoring sensors and the tilt sensor. The interior monitoring sensors of the TT Roadster '07 now use ultrasound. The predecessor model of the TT Roadster used microwaves.

The anti-theft alarm sensor G578 is again integrated in the overhead module. Both the sensor G578 and the overhead module are parts adopted from the TT Coupé '07.

Despite the use of identical components, the anti-theft alarm sensor G578 must know what vehicle it is installed in.

This information is provided by a bit using the coding of the convenience system central control unit J393, which differentiates between the TT Coupé and the TT Roadster.

Protected by copyright. This document, in whole or in part, is not permitted unless authorized by AUDI AG. AUDI AG does not guarantee or accept any liability with respect to the correctness of information in this document. Copyright by AUDI AG.

Overhead module with anti-theft alarm sensor G578

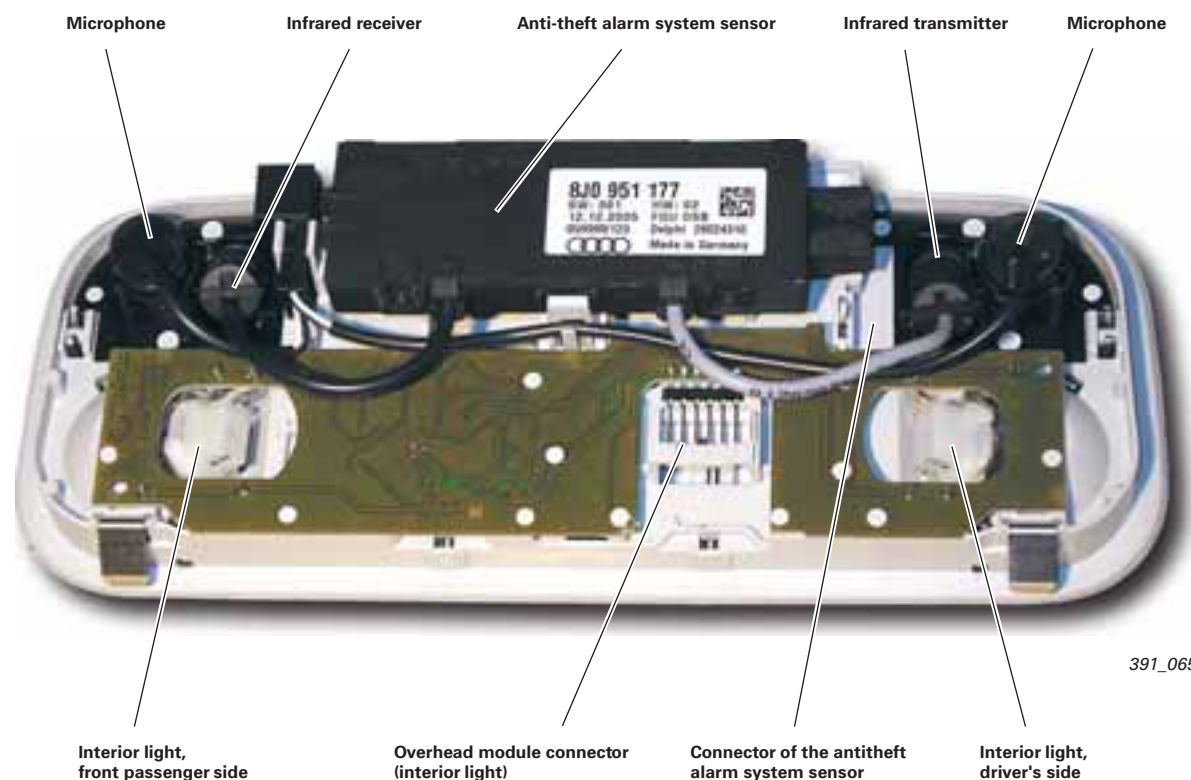

391_065

With regard to the functional principle of the anti-theft alarm, please note that the alarm system cannot be activated unless the convertible top is closed.

If the convertible top is closed and one of the windows in the vehicle is open, the anti-theft alarm can be activated, but will operate at a lower sensitivity level.

Radios and radio navigation systems

In this regard, the TT Roadster has the same hardware specification as in the TT Coupé '07. For an overview of the basic functions, refer to SSP 380, page 48 onwards.

chorus, concert and symphony radios in the 2-DIN housing

The following new functions will be available from autumn 2006:

- CD pause while radio is in mute mode (manual or via telephone)
- LOADING is displayed while changing the selected CD in the CD changer
- Seek function configuration in the MENU:
 - normal seek according to station frequency or comfort seek across RDS station family.
 - During the comfort seek, the RDS service PI (= programme information) is evaluated.
- Clock time display on the radio display (North America only): when the radio is OFF or if the radio is not operated for some time, the clock time of the dash panel insert is shown on the radio display. This function can be turned ON and OFF using the MENU key.

The radio software is non-flashable, which means that the new functions cannot be installed in older systems.

Navigation System Plus

The new TT Roadster also includes Navigation System Plus (RNS-E), both in the TT Coupé and in the TT Roadster. The following features of Navigation System Plus have been adapted for the Audi TT:

- New **front trim design** adapted to match the interior of the TT.
- **Transport mode:** Transport mode has been extended to include a DVD eject button lock. The navigation DVD is loaded into the system during production. The locked eject button prevents removal of the DVD from the vehicle while the vehicle is in transit to the dealer.
- **Power-up screen:** The power-up screens adapted to the vehicle can be selected using the diagnostic tester.

- Support for the **BOSE Surround amplifier** in the Premium sound system. Navigation System Plus sends a CAN message indicating whether the audio output signal to the amplifier is from an analog source (FM, AM, TV) or a digital source (CD, MP3). The BOSE amplifier reproduces only digital audio sources in surround sound, as only digital sources are true stereo sources. Analog sources are not reproduced in surround sound. It is possible to receive mono signals when using analog sources. Surround sound is not possible with mono signals, since a stereo signal with differences between the left and right audio channels is needed to create the 3D sound effect. As with the current radios or the navigation system (BNS 5.0), surround sound is not configurable.

The navigation system (BNS 5.0) is unchanged from that in the TT Coupé.



391_097

Sound system

The sound systems are based on the sound systems in the TT Coupé '07 (refer to SSP 382).

Basic sound

The basic sound system with four loudspeakers in combination with the chorus radio is identical to the basic sound system in the TT Coupé. It uses the audio amplifier in the Chorus radio.

The Chorus radio does not evaluate the convertible top position. The loudspeakers cannot be muted during convertible top operation.

Standard sound

The standard sound system has been slightly modified compared to the system in the TT Coupé. The software of the "digital sound package control unit J525" (amplifier) has been extended for the roadster to include the following features:

- **Sound tuning for convertible top open and closed**

To ensure an optimum sound both when the convertible top is open and closed, sound tunings have been configured for these convertible top conditions. In the case of the manual convertible top, the digital sound package control unit J525 evaluates a CAN message from the onboard power supply control unit J519. In the case of the automatic convertible top, the digital sound package control unit J525 evaluates a message from the convertible top operation control unit J256. The sound set-up is changed over when opening and closing the convertible top at the start of the door glass operating cycle. Sound output is muted briefly to ensure a pleasant transition for the listener. The duration of muting is similar to that when changing radio stations using the station keys.

- **Sound correction during phone calls or voice control of the Navigation plus**

The digital sound package control unit J525 evaluates CAN messages from the telephone transmitter and receiver unit R36 or the Navigation plus system with voice control and thereupon sets the sound system to optimum voice quality.

This amplifier will also be installed in the TT Coupé from autumn 2006.

The loudspeakers are identical to the loudspeakers in the TT Coupé.

BOSE Surround Sound

The amplifier in the BOSE sound system has also been adapted for use in the Roadster. The software modifications are identical to the modifications to the standard amplifier (see above). This amplifier will also be installed in the TT Coupé in combination with software version 120 or higher. The BOSE Audio Pilot technology is ideal for a roadster. It measures the ambient noise with a microphone and the adjusts volume and sound in the amplifier so that the listener does not perceive any change in sound quality.

The subwoofer is built into the TT Roadster in the rear bulkhead of the occupant cell, on the right adjacent the optional ski bag. All other loudspeakers are identical to the loudspeakers in the TT Coupé.

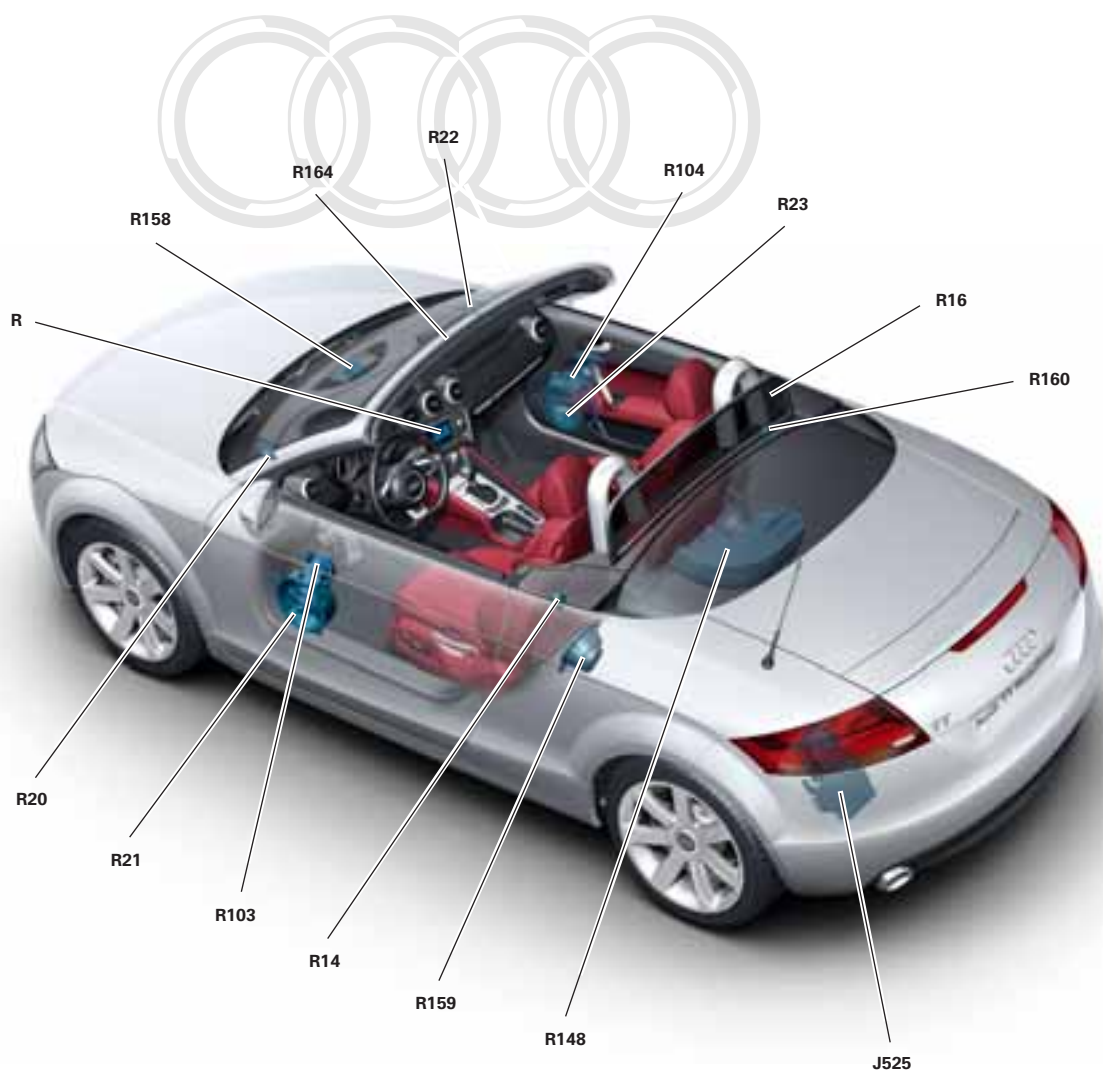

391_035

Legend:

- | | | | |
|------|-------------------------------------|------|---|
| J525 | Digital sound package control unit | R103 | Front left mid-range loudspeaker (BOSE Surround Sound only) |
| R | Radio | R104 | Front right mid-range loudspeaker (BOSE Surround Sound only) |
| R14 | Rear left treble loudspeaker | R148 | Centre loudspeaker - subwoofer (BOSE Surround Sound only) |
| R16 | Rear right treble loudspeaker | R158 | Mid-range/treble loudspeaker, centre |
| R20 | Front left treble loudspeaker | R159 | Mid-range/treble loudspeaker, rear left |
| R21 | Bass loudspeaker, front left | R160 | Mid-range/treble loudspeaker, rear right |
| R22 | Front right left treble loudspeaker | R164 | Microphone unit in front overhead module (BOSE Surround Sound only) |
| R23 | Bass loudspeaker, front right | | |

Aerials

All-new aerial systems have been developed for the Audi TT Roadster. A compact solution as implemented in the Coupé in the boot lid and in the roof was not possible for the TT Roadster.

The aerials for the TT Roadster are a stub aerial at the rear left, a metal-plate aerial behind the rear cross panel on the right and, in vehicles equipped with a TV tuner, in the windscreen on the right, left and behind the interior light on the front windscreen frame.

Aerial amplifiers for radio and TV are installed at the base of the stub aerial, in the luggage compartment at the rear right and behind the A-post trims in vehicles equipped with a TV tuner.



391_023



Common solution for all vehicles
 Protected by copyright. Copying for private or commercial purposes, in part or in whole, is not permitted without the prior written consent of AUDI AG. AUDI AG does not guarantee or accept any liability with respect to the correctness of information in this document. Copyright by AUDI AG.

The central locking aerial is integrated in the stub aerial. The aerial amplifier R24 is integrated in the base of the stub aerial. The signal is transmitted from the aerial amplifier R24 to the convenience system central control unit J393. The telephone aerial R65 and the navigation system aerial R50 are always integrated in the windscreen frame behind the interior light W1.

The telephone and navigation aerials are only fitted in vehicles equipped ex works with a navigation system or a mobile phone adapter. In all markets except North America, the aerial amplifier, mobile telephone R86 is installed behind the right dash panel cover in order to compensate for telephone signal loss. The aerial amplifier, mobile telephone R86 boosts signals for GSM 900 and GSM 1800 telephone networks.

Aerial system for radios

The chorus, concert and symphony radios have FM tuners with phase diversity (refer to SSP 382, TT Coupé '07 - Infotainment). These radios have two aerial inputs. The aerial amplifier R24 is connected to aerial input 1. Both FM and AM aerial signals are received via this connection.

Aerial amplifier R24 is integrated in the base of the stub aerial.

Aerial input 2 receives only FM signals and is not connected to aerial amplifier -2- in the luggage compartment on the rear right. Aerial amplifier -2- receives signals from the metal-plate aerial behind the rear cross panel on the right.

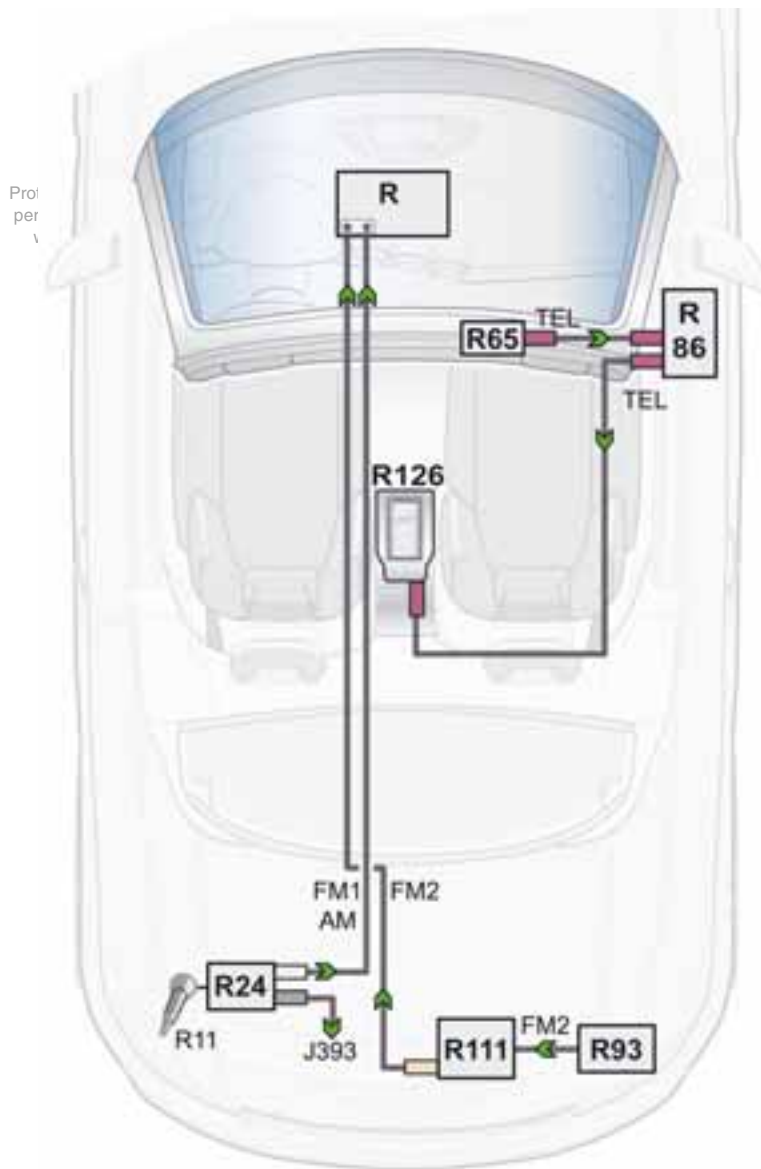

391_019

Legend:

J393 Convenience system central control unit
 R Radio
 R24 Aerial amplifier
 R65 Telephone aerial

R86 Aerial amplifier, mobile telephone
 R93 Radio aerial 2
 R111 Aerial amplifier -2-
 R126 Telephone bracket

Aerial system for radio navigation systems (without TV tuner)

The BNS 5.0 and RNS-E radio navigation systems have FM tuners with switched diversity. In these radios, aerial switching takes place in an external aerial amplifier with aerial selection. The radio has an aerial input (HF signal) and a signal output (IF signal). The IF signal is evaluated by an aerial amplifier. If the signal is too weak, this aerial amplifier switches to the other aerial.

In vehicles equipped with a radio navigation system without TV tuner, the serial selection function is integrated in aerial amplifier -2- R111. Aerial amplifier -2- R111 receives signals from both radio aerials and can switch between both aerials when FM reception is desired. When AM reception is desired, aerial amplifier -2- R111 is always switched to the stub aerial.

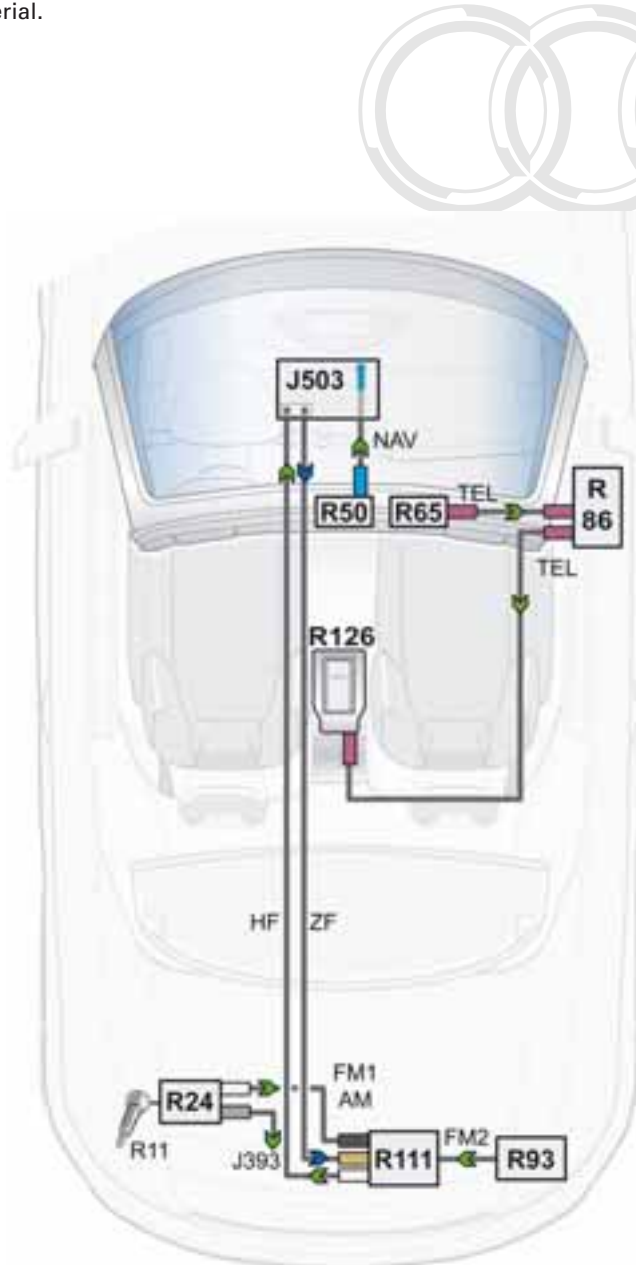

commercial purposes, in part or in whole, is not DI AG does not guarantee or accept any liability on in this document. Copyright by AUDI AG.

391_077

Legend:

J393	Convenience system central control unit	R65	Telephone aerial
J503	Control unit with display for radio and navigation	R86	Aerial amplifier, mobile telephone
R24	Aerial amplifier	R93	Radio aerial 2
R50	Navigation aerial	R111	Aerial amplifier -2-
		R126	Telephone bracket

Aerial system for Navigation plus (RNS-E) and TV tuner

The Navigation plus system (RNS-E) has an FM tuner with switched diversity. If an auxiliary TV tuner is fitted in the vehicle, an aerial selection control unit J515 for switching the radio aerials is installed in the luggage compartment at the front right.

The aerial selection control unit receives signals from the two aerial amplifiers R24 and R111 and can switch between the two aerial amplifiers when FM reception is desired. When AM reception is desired, the aerial selection control unit J515 is always switched to the aerial amplifier R24.

For TV reception, a total of 3 aerials with 3 aerial amplifiers are fitted. The metal-plate aerial serving as FM aerial 2 is also used as aerial 1.

Aerial amplifier -2- R111 splits radio and TV signals and sends the TV signals to aerial input 1 of the TV tuner.

TV aerials 2 and 3 are integrated in the windscreen. There is an aerial amplifier in each of the A-posts. These amplifiers send the aerial signals to the TV tuner in the luggage compartment at the rear right.

A TV tuner is not available yet, and likewise this aerial system.

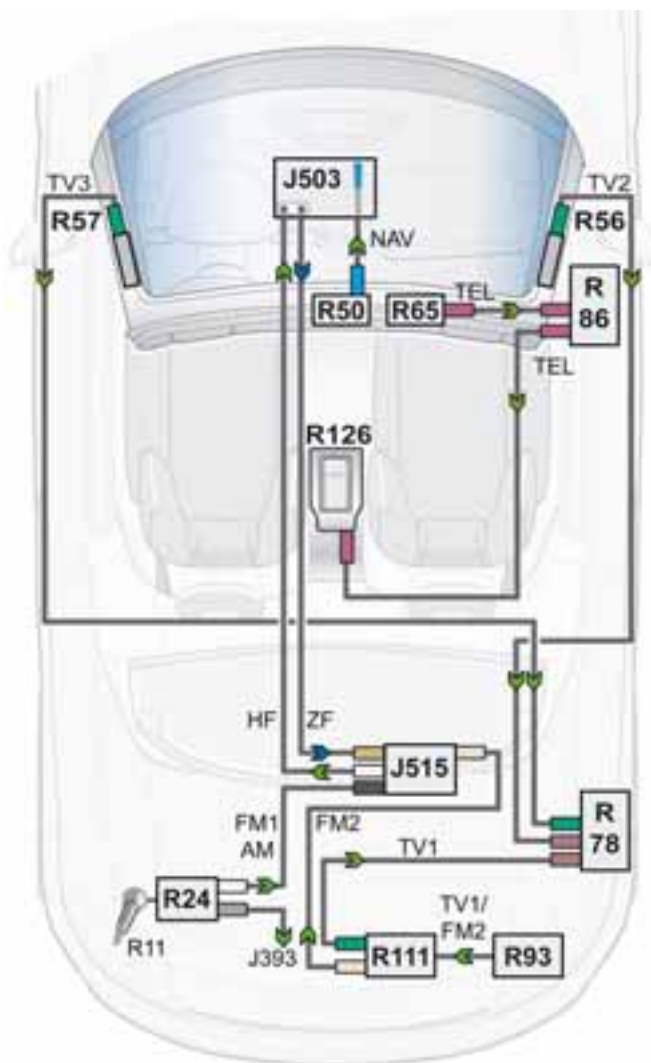

Legend:

J393	Convenience system central control unit	R57	TV aerial -3-
J503	Control unit with display for radio and navigation	R65	Telephone aerial
J515	Aerial selection control unit	R78	TV tuner
R24	Aerial amplifier	R86	Aerial amplifier, mobile telephone
R50	Navigation aerial	R93	Radio aerial 2
R56	TV aerial -2-	R111	Aerial amplifier -2-
		R126	Telephone bracket



391 020
 * commercial purposes, in part or in whole, is not permitted. JDI AG does not guarantee or accept any liability for errors in this document. Copyright by AUDI AG.

All rights reserved. Technical specifications subject to change without notice.

Copyright
AUDI AG
I/VK-35
Service.training@audi.de
Fax +49-841/89-36367

AUDI AG
D-85045 Ingolstadt
Technical status: 12/06

Printed in Germany
A07.5S00.33.20