



Protected by copyright. Copying for private or commercial purposes, in part or in whole, is not permitted unless authorised by AUDI AG. AUDI AG does not guarantee or accept any liability with respect to the correctness of information in this document. Copyright by AUDI AG.

New data bus systems –

LIN, MOST, Bluetooth™

Self Study Programme 286

The constantly increasing demand for additional functions and convenience in the vehicle calls for the use of ever more wide ranging electronics.

Whereas the first Audi A8 model introduced in 1994 required a maximum of only 15 control units for implementation of all vehicle functions, this number will increase five-fold in the Audi A8 '03.

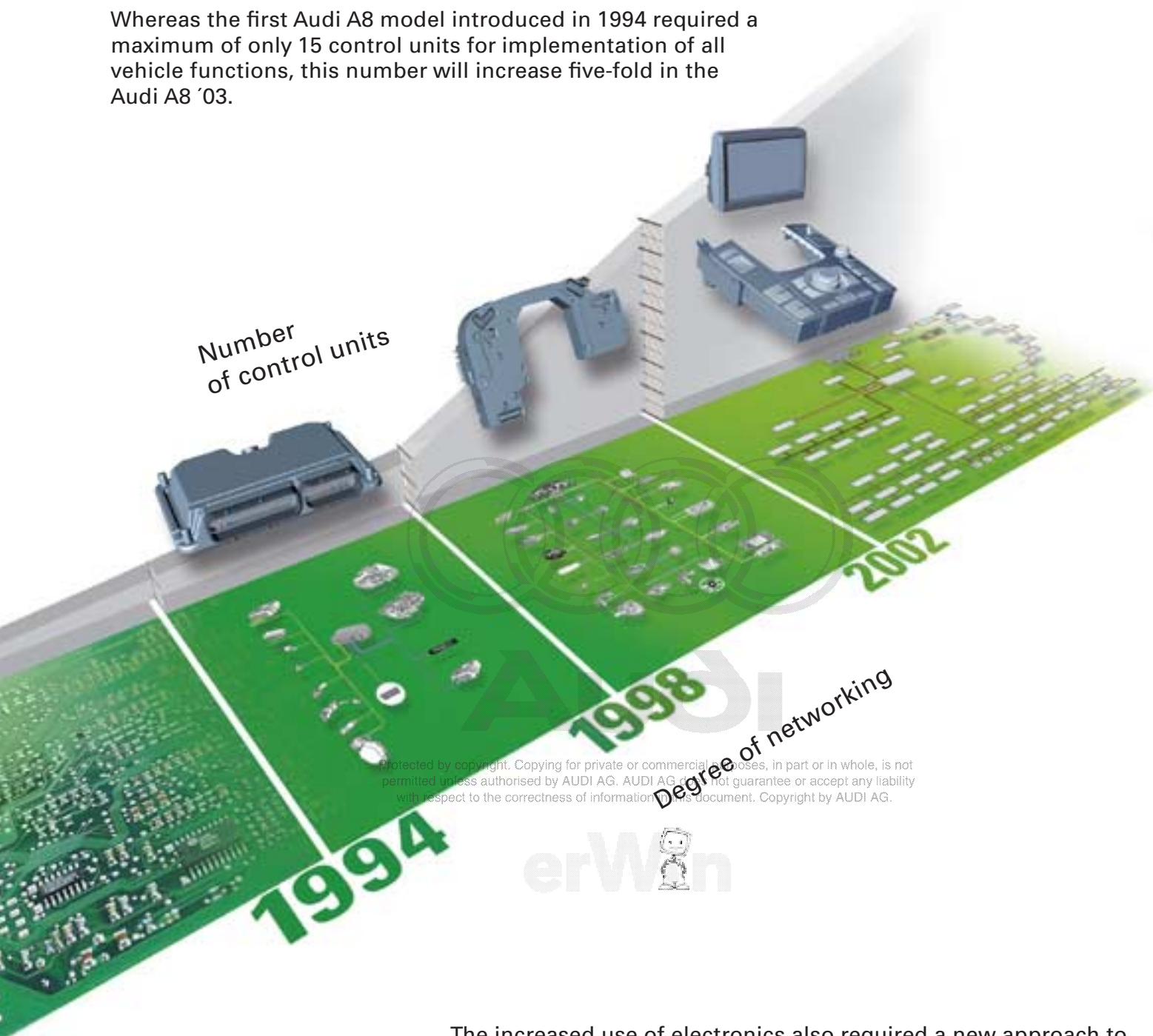

The increased use of electronics also required a new approach to data transfer between the individual control units.

A first important step towards this was the introduction of the CAN data bus at Audi in the mid 1990s. This system does however have its limitations, particularly with regard to the transmission rates involved in the infotainment sector. The only solution is therefore to employ transmission systems designed to deal with specific requirements. Service and diagnosis functions will also benefit from this development.

	Page
Introduction	4
 LIN bus - The single-wire data bus	
Introduction	6
Data transfer	9
Messages	11
Diagnosis	16
 MOST bus - The optical data bus	
Introduction	17
Design of control units	20
Optical fibre	23
Attenuation in optical bus	27
Ring configuration of MOST bus	30
MOST bus system statuses	31
Frames	33
Operating sequences in MOST bus	36
Diagnosis	41
 Bluetooth™ - The wireless data bus	
Introduction	44
Operation	46
Diagnosis	49
Diagnosis bus	50

Protected by copyright. Copying for private or commercial purposes, in part or in whole, is not permitted unless authorised by AUDI AG. AUDI AG does not guarantee or accept any liability with respect to the correctness of information in this document. Copyright by AUDI AG.



The Self Study Programme contains information on design features and functions.

The Self Study Programme is not intended as a Workshop Manual! Values given are only intended to help explain the subject matter and relate to the software version applicable at the time of SSP compilation.

Use should always be made of the latest technical publications when performing maintenance and repair work.

New!



**Attention!
Note!**



Introduction



Topology

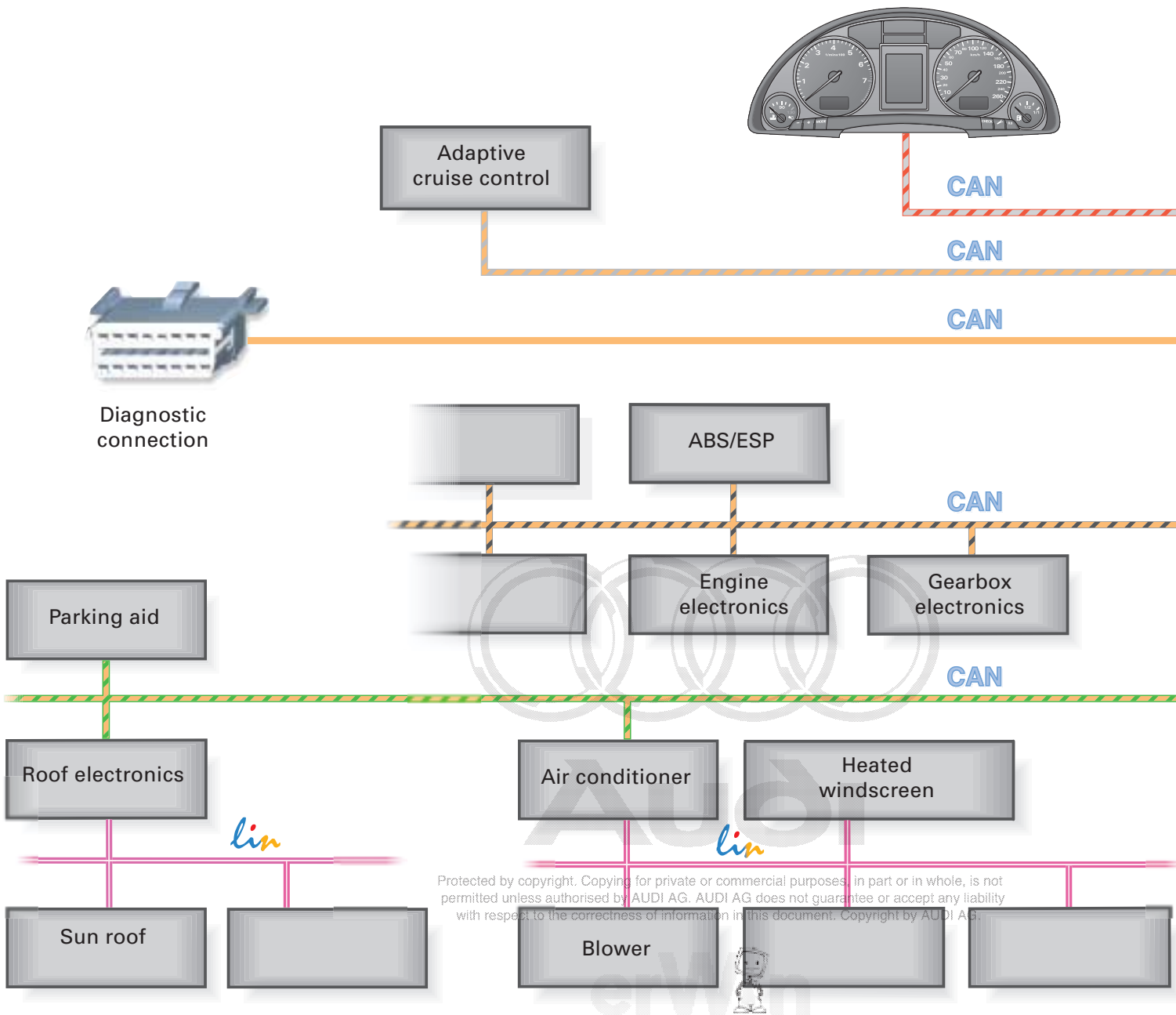

Working on the basis of the existing level of networking, improved transmission technology is required to deal with the great number of control units and their range of functions as well as the increasing volume of data exchange.

This involves the use of

- The LIN bus (single-wire bus)
- The MOST bus (optical bus)
- The wireless Bluetooth™ bus

in addition to the familiar CAN bus.

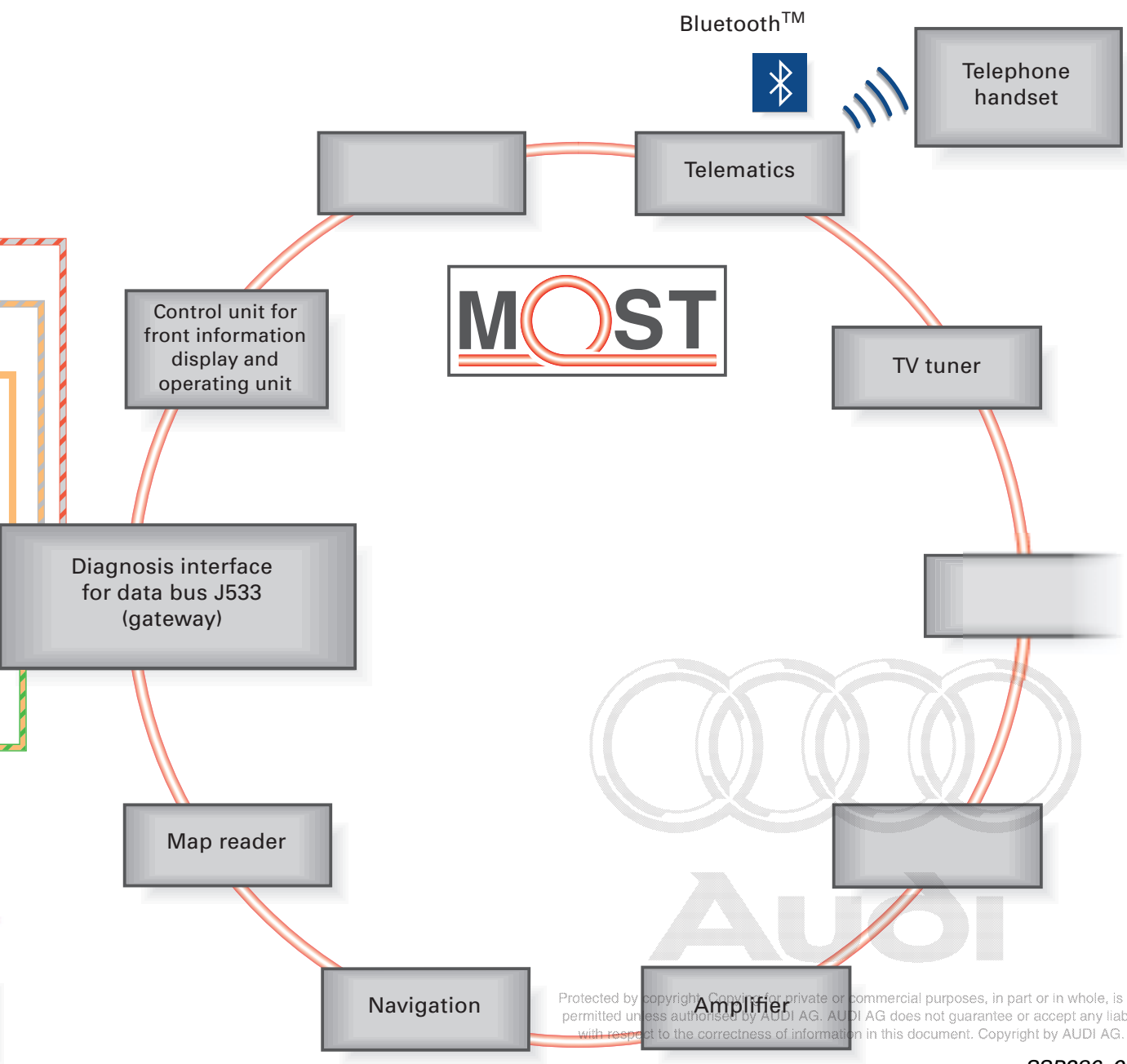

Protected by copyright. Copying for private or commercial purposes, in part or in whole, is not permitted unless authorised by AUDI AG. AUDI AG does not guarantee or accept any liability with respect to the correctness of information in this document. Copyright by AUDI AG.

SSP286_001

- Drive system CAN
- Dash panel insert CAN
- Adaptive cruise control CAN
- Diagnosis CAN
- Convenience CAN
- LIN bus
- Optical bus - MOST

LIN bus

Introduction

LIN stands for **Local Interconnect Network**.

Local Interconnect means that all control units are located within a limited structural space (e.g. roof). This is also referred to as "local sub-system".

Data are exchanged between the individual LIN bus systems in a vehicle by one control unit in each case using the CAN data bus.

The LIN bus system is a single-wire bus. The wire has a basic colour (violet) and a code colour. The wire cross-section is 0.35 mm². A screen is not necessary.



LOCAL INTERCONNECT NETWORK

The system permits data exchange between one LIN master control unit and up to 16 LIN slave control units.



LIN master 1
Air conditioner control unit

lin air conditioner

LIN slave 1
Heated windscreen

LIN slave 3
PTC additional
heater (right)

LIN slave 2
Fresh-air blower

Protected by copyright. Copying for private or commercial purposes, in part or in whole, is not permitted without the prior written consent of AUDI AG. AUDI AG does not guarantee or accept any liability with respect to the correctness of information in this document. Copyright © 2008 Audi AG

LIN slave 4
PTC additional
heater (left)

LIN master 2
Front roof module

lin roof module

LIN slave 1
Sun roof motor

SSP286_014

LIN master control unit

The control unit connected to the CAN data bus implements the LIN master functions.

Functions

- Monitoring of data transfer and data transfer rate.
The LIN master control unit transmits the header (refer to Page 12).
- The software contains a cycle specifying when and how often which message is transmitted to the LIN data bus.
- Implementation of translation function between the LIN control units of the local LIN bus system and the CAN data bus. It is thus the only control unit in the LIN bus system which is connected to the CAN data bus.
- Diagnosis for the connected LIN slave control units takes place via the LIN master control unit.

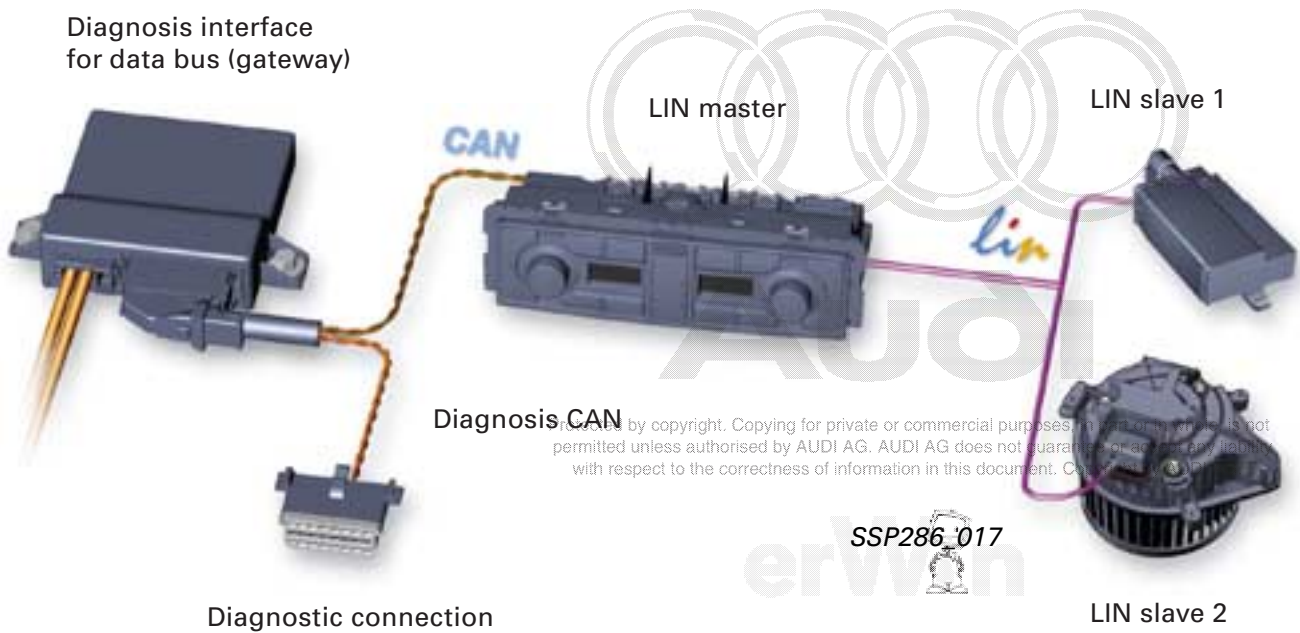

LIN bus

LIN slave control units

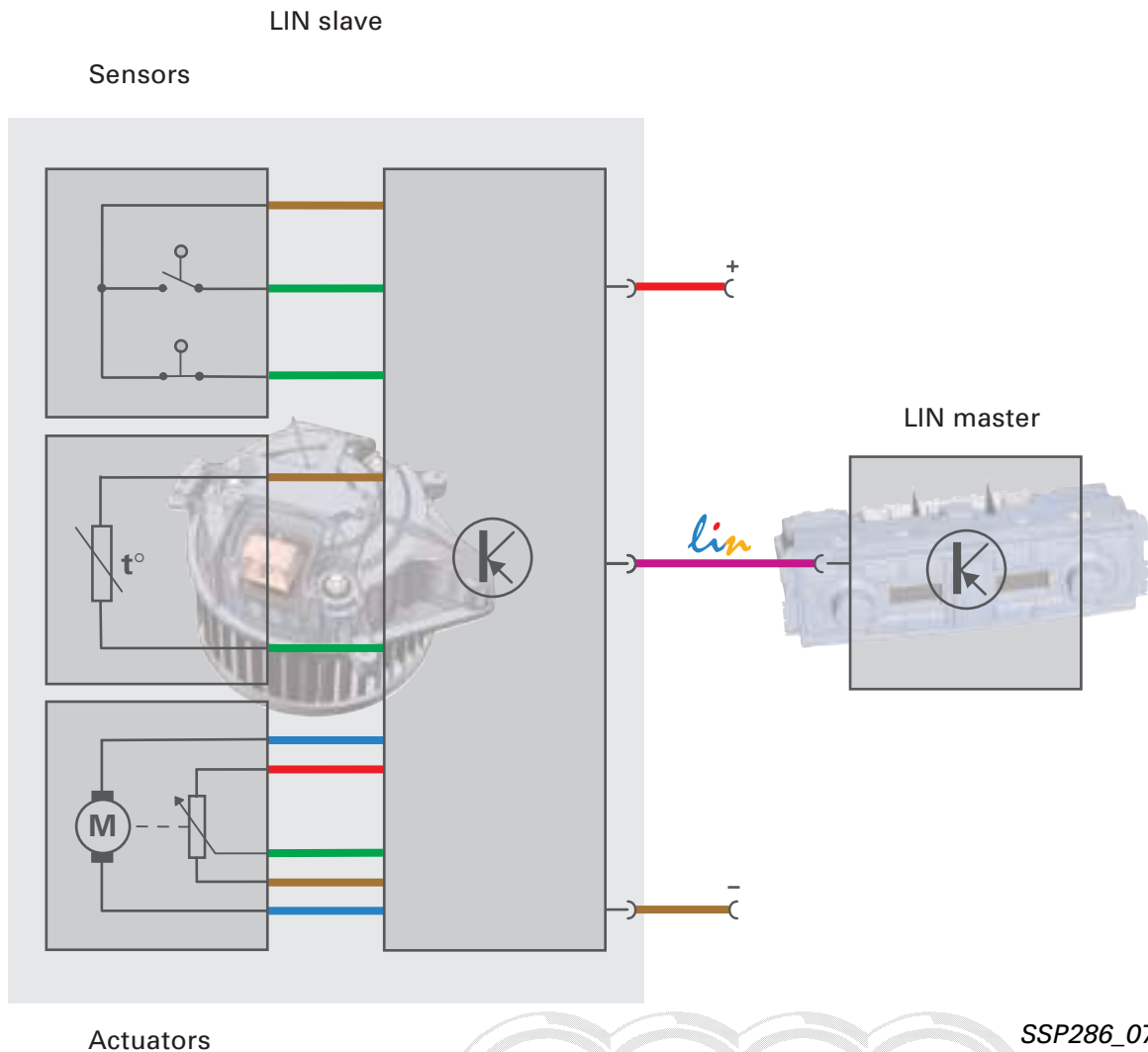

SSP286_070

Individual control units, such as the fresh-air blower, or sensors and actuators, for instance tilt sensor or anti-theft alarm sounder, can be used as LIN slave control units within a LIN data bus system.

Integrated sensor electronics evaluate the measured values. The values are then transmitted as a digital signal by the LIN bus.

Only one pin of the LIN master socket is required for several sensors and actuators.

The LIN actuators are intelligent electronic or electromechanical assemblies which are informed of their tasks by the LIN master control unit in the form of the LIN data signal. The LIN master can interrogate the actual status of the actuators by way of integrated sensors, thus permitting desired/actual comparison.

Protected by copyright. Commercial use, in part or in whole, is not permitted unless authorised by AUDI AG. AUDI AG does not guarantee or accept any liability for the correctness of information in this document. Copyright by AUDI AG.

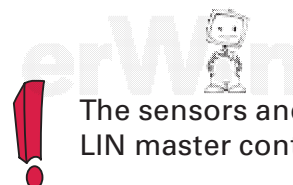

The sensors and actuators only react if the LIN master control unit transmits a header.

Data transfer

The data transfer rate is 1 - 20 kbit/s and is specified in the software of the LIN control units. This corresponds to a maximum of one fifth of the data transfer rate of the convenience CAN.

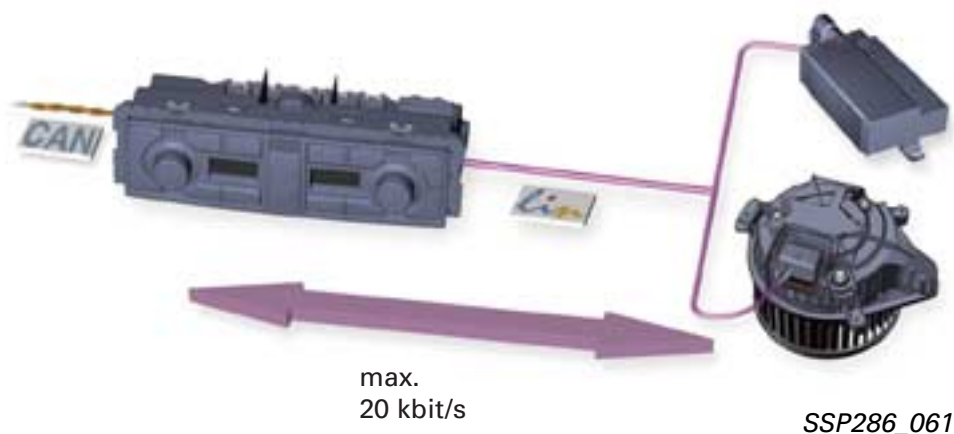

Signal

Recessive level

If no message or a recessive bit is being transmitted on the LIN data bus, the voltage at the data bus wire is roughly equivalent to battery voltage.

Dominant level

For transfer of a dominant bit on the LIN data bus, the data bus wire is connected to earth by a transceiver in the transmitter control unit.

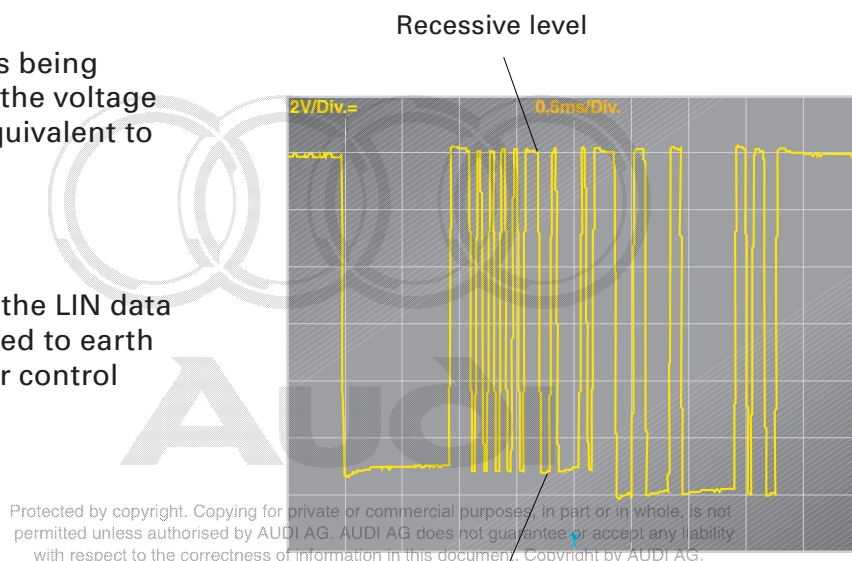

SSP286_071



Differences may be seen between the dominant levels on account of different transceiver designs in the control units.



Dominant level

LIN bus

Reliability

Stable data transfer is guaranteed by specified transmission and reception tolerances with regard to both the recessive and dominant levels.

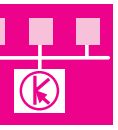

Transmission voltage range

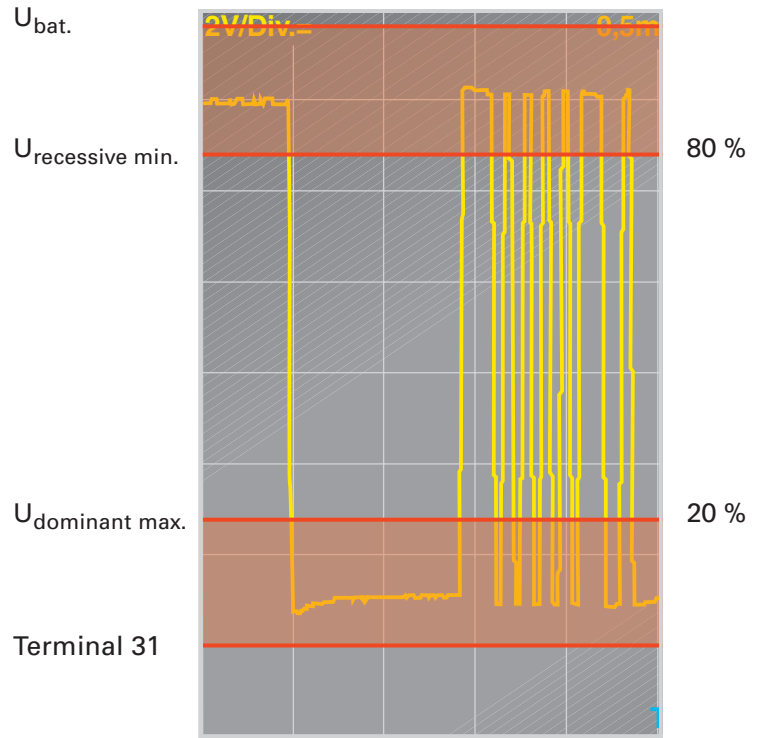

SSP286_016

In order to obtain reception of valid signals in spite of interference, the permissible voltage ranges on the reception end are larger.

Reception voltage range

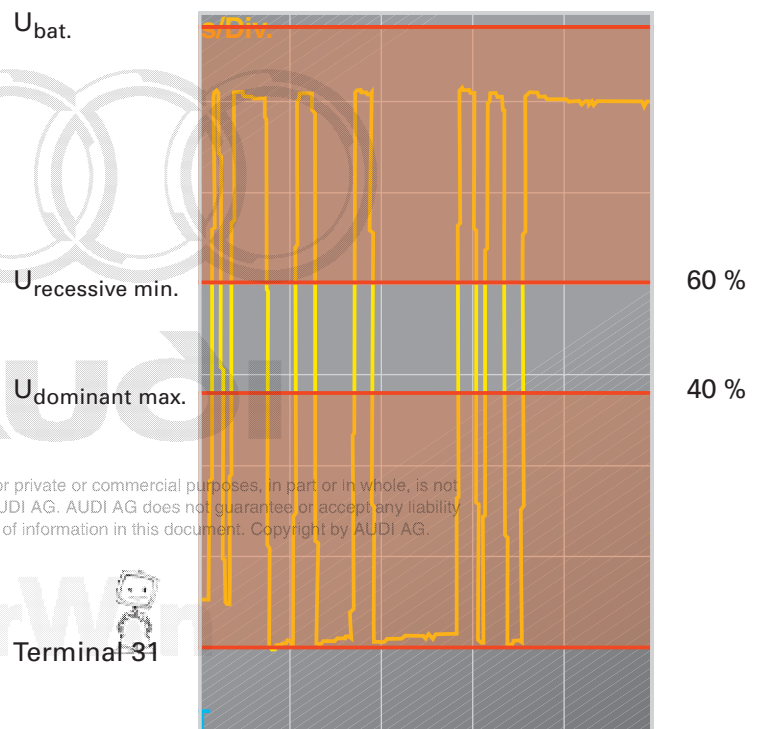

Protected by copyright. Copying for private or commercial purposes, in part or in whole, is not permitted unless authorised by AUDI AG. AUDI AG does not guarantee or accept any liability with respect to the correctness of information in this document. Copyright by AUDI AG.



Messages

Header
(refer to Page 12)
Transmitter: LIN master

Response
(refer to Page 13)
Transmitter: LIN master or LIN slave

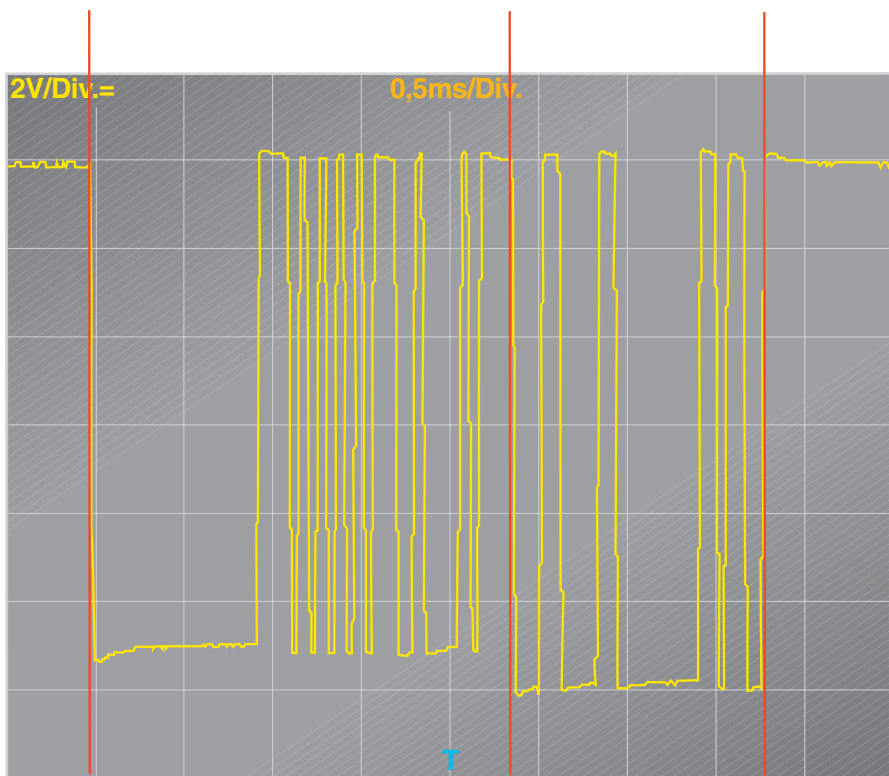

SSP286_072

Message with slave response

In the header, the LIN master control unit requests a LIN slave control unit to transmit information (e.g. switch statuses or measured values).

The response is transmitted by the LIN slave control unit.

Message with master command

By way of the identifier in the header, the LIN master control unit requests the corresponding LIN slave control units to process the data contained in the response.

The response is transmitted by the LIN master control unit.

Protected by copyright. Copying for private or commercial purposes, in part or in whole, is not permitted unless authorised by AUDI AG. AUDI AG does not guarantee or accept any liability with respect to the correctness of information in this document. Copyright by AUDI AG.

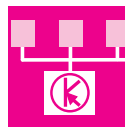

Header

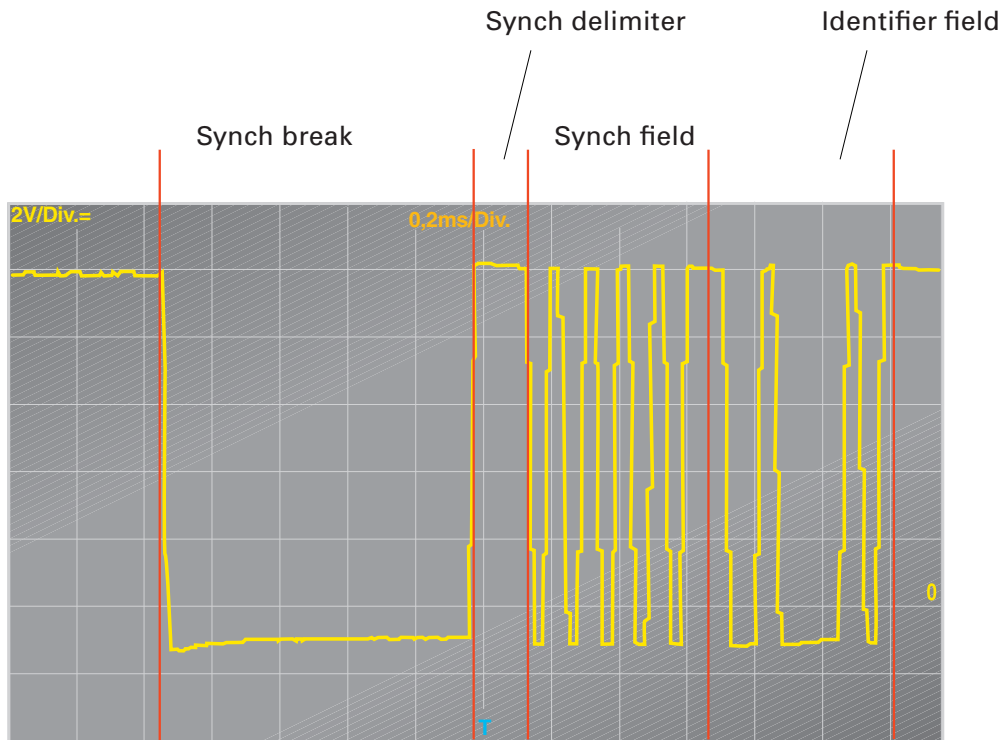

SSP286_073

The header is transmitted cyclically by the LIN master control unit.

It can be divided into four sections:

- Synch break
- Synch delimiter
- Synch field
- Identifier field

The **synch break** has a length of at least 13 bit periods and is transmitted with dominant level.

The 13 bit period is necessary to unequivocally indicate the start of a message to all LIN slave control units.

A maximum of 9 dominant bits are consecutively transmitted in the other message sections.

The **synch delimiter** has a length of at least 1 bit and is recessive ($\approx U_{bat.}$).

The **synch field** consists of the bit sequence 0 1 0 1 0 1 0 1. This bit sequence enables all LIN slave control units to adapt to (become synchronised with) the system clock of the LIN master control unit.

The synchronisation of all control units is essential to proper data exchange. Without synchronisation, the bit values would be inserted at an incorrect location in the message at the receiver. Data transfer errors would result.

The **identifier field** has a length of 8 bit periods. The first 6 bits contain the identification and the number of data fields (refer to Page 14) of the response.

The number of data fields in the response can be between 0 and 8.

The last two bits contain the checksum of the first 6 bits for detection of transmission errors. The checksum is required to prevent assignment to an incorrect message in the event of identifier transmission errors.

Protected by copyright. Copying for private or commercial purposes is prohibited. Audi AG does not accept any liability with respect to the correctness of information in this document. Copyright by AUDI AG.



Response

In the case of a message with slave response, a LIN slave control unit supplies the response with information on the basis of the identifier.

Example:

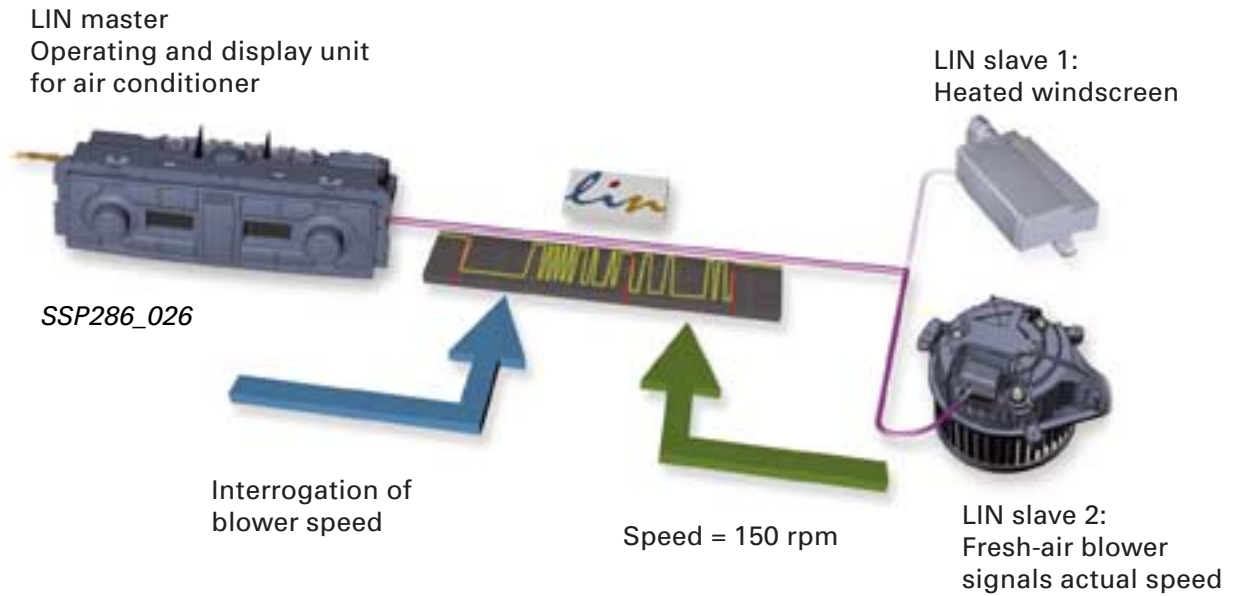

In the case of a message with a data request from the master, the LIN master control unit supplies the response.

In line with the identifier, the corresponding LIN slave control units process the data for implementation of functions.

Example:

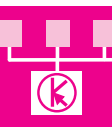
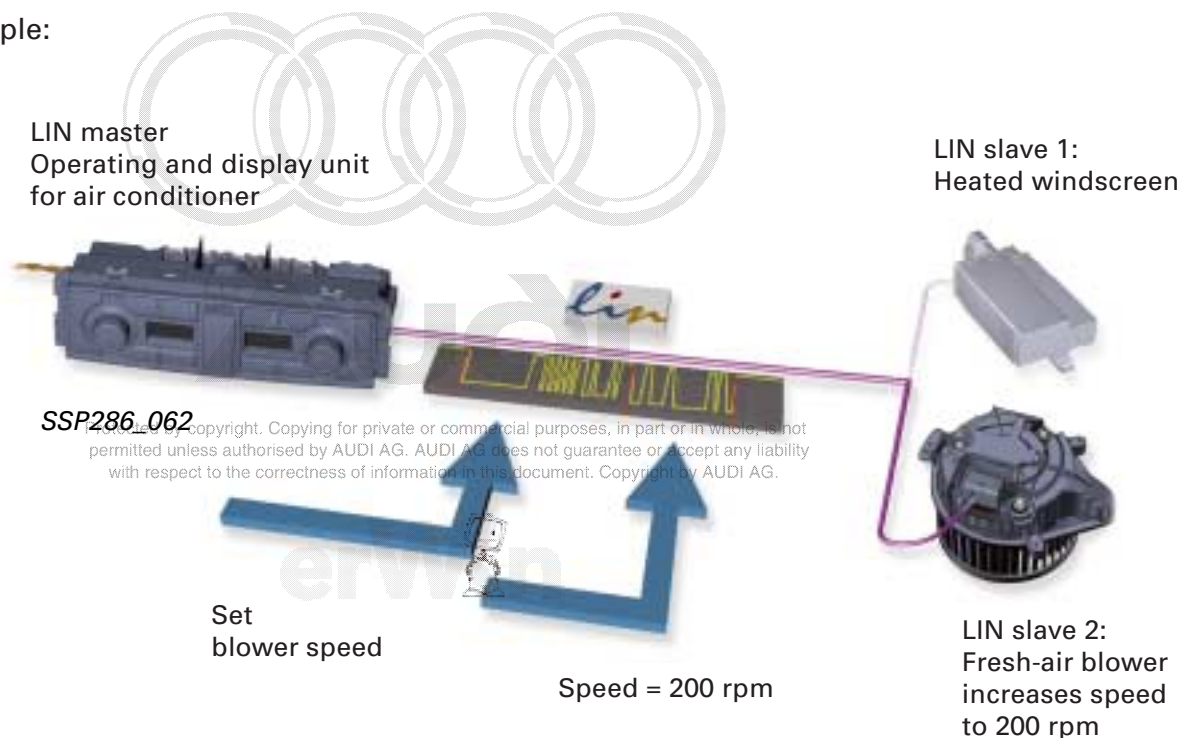

LIN bus

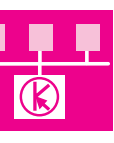

The response consists of 1 to 8 data fields. One data field is made up of 10 bits. Each data field comprises a dominant start bit, a data byte (containing the information) and a recessive stop bit. The start and stop bit are used for post-synchronisation and thus to avoid transmission error.

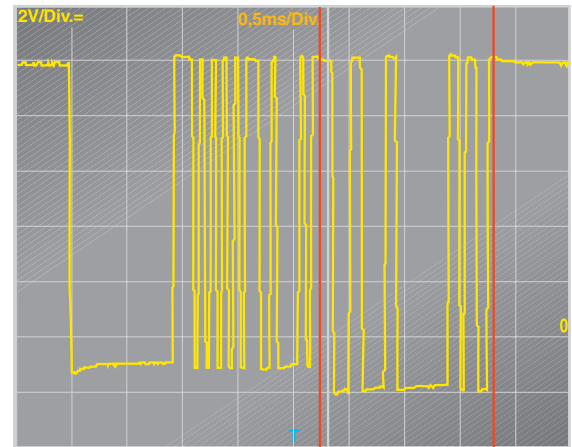

SSP286_074

Response

Sequence of messages

The LIN master control unit transmits the headers and, in the case of master messages, the responses, cyclically to the LIN bus in accordance with a sequence specified in its software.

Frequently required information is transmitted several times.

Statuses affecting the LIN master control unit may alter the message sequence.

Examples:

- Ignition ON/OFF
- Diagnosis active/inactive
- Side lights ON/OFF

In order to reduce the number of LIN master control unit component options, the master control unit transmits the headers for the control units of a fully equipped vehicle to the LIN bus.

Control units for special equipment not fitted result in headers with no responses on the oscillogram.

This has no effect on system operation.



Audi

Protected by copyright. Copying for private or commercial purposes, in part or in whole, is not permitted unless authorised by AUDI AG. AUDI AG does not guarantee or accept any liability with respect to the correctness of information in this document. Copyright by AUDI AG.

erW



Dominant

Recessive

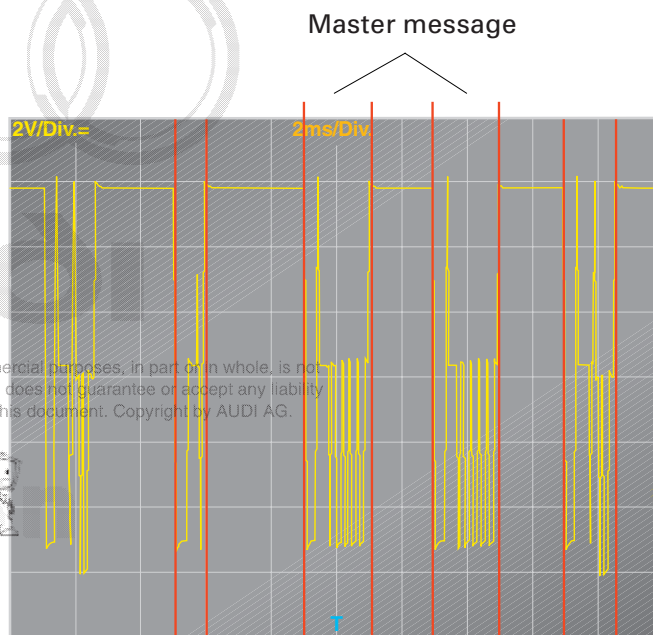

SSP286_075

Header with no response

Slave message (characterised by different dominant levels)

Anti-theft system

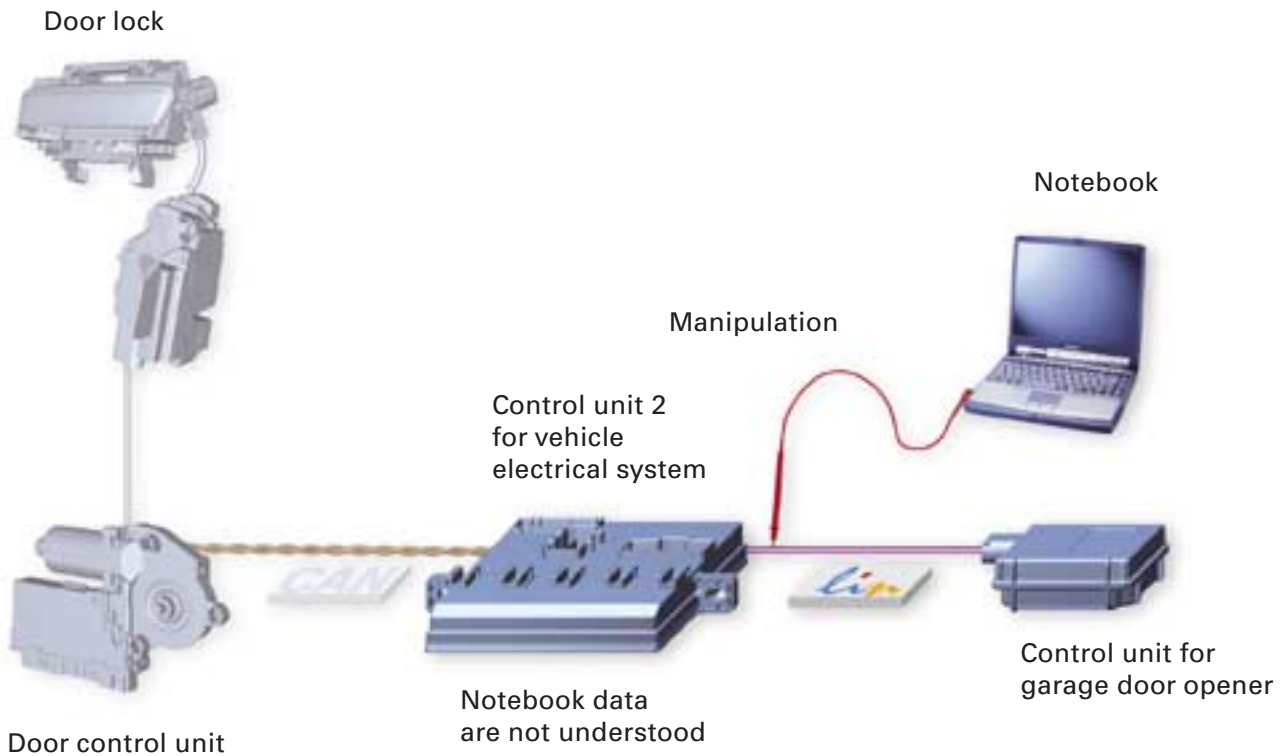

SSP286_065

Data are only transferred in the LIN bus system if the LIN master control unit transmits a header with the appropriate identifier.

The full monitoring of all messages by the LIN master control unit makes it impossible to manipulate any LIN wire on the outside of the vehicle. The LIN slave control unit can only respond.

Thus, for example, the doors cannot be unlocked by way of the LIN bus.

This arrangement makes it possible to install LIN slave control units (e.g. garage door opener control unit in front bumper) on the outside of the vehicle.

Protected by copyright. Copying for private or commercial purposes, in part or in whole, is not permitted unless authorised by AUDI AG. AUDI AG does not guarantee or accept any liability for the content of this document. All rights reserved. Copyright by AUDI AG.

erWin

LIN bus

Diagnosis

LIN bus system diagnosis is performed by way of the LIN master control unit address word.

All self-diagnosis functions can be implemented for the LIN slave control units.

The diagnostic data are transferred from LIN slave control units to the LIN master control unit by the LIN bus.

Fault location	Fault message	Cause of fault entry
LIN slave control unit e.g. blower control	No signal/ no communication	No data transfer by LIN slave control unit over a period stipulated in LIN master software - Open circuit in wiring or short circuit - Fault in power supply of LIN slave control unit - Incorrect LIN slave or LIN master component option - Fault in LIN slave control unit
LIN slave control unit e.g. blower control	Implausible signal	Checksum error Incomplete message transmission - Electromagnetic interference on LIN wire - Change in capacitance and resistance on LIN wire (e.g. moisture/ dirt at connector housing) - Software problem (incorrect component options)

Introduction

In addition to the familiar CAN bus systems, use has been made for the first time in the Audi A8 '03 of an optical data bus system.

The name of this data bus system is derived from "Media Oriented Systems Transport (MOST) Cooperation". This is an association formed by various motor vehicle manufacturers, their suppliers and software companies with a view to developing a standard high-speed data transfer system.



The term "Media Oriented Systems Transport" signifies a network featuring media-oriented data transport. This means that, in contrast to the CAN data bus, address-oriented messages are transmitted to a specific receiver.

This technique is used in Audi vehicles for the transfer of infotainment system data.

The infotainment system offers a wide range of modern **information and entertainment** media as outlined below.



Protected by copyright. Copying for private or commercial purposes, in part or in whole, is not permitted unless authorised by AUDI AG. AUDI AG does not guarantee or accept any liability with respect to the correctness of information in this document. Copyright by AUDI AG.

MOST bus

Transfer rates of media

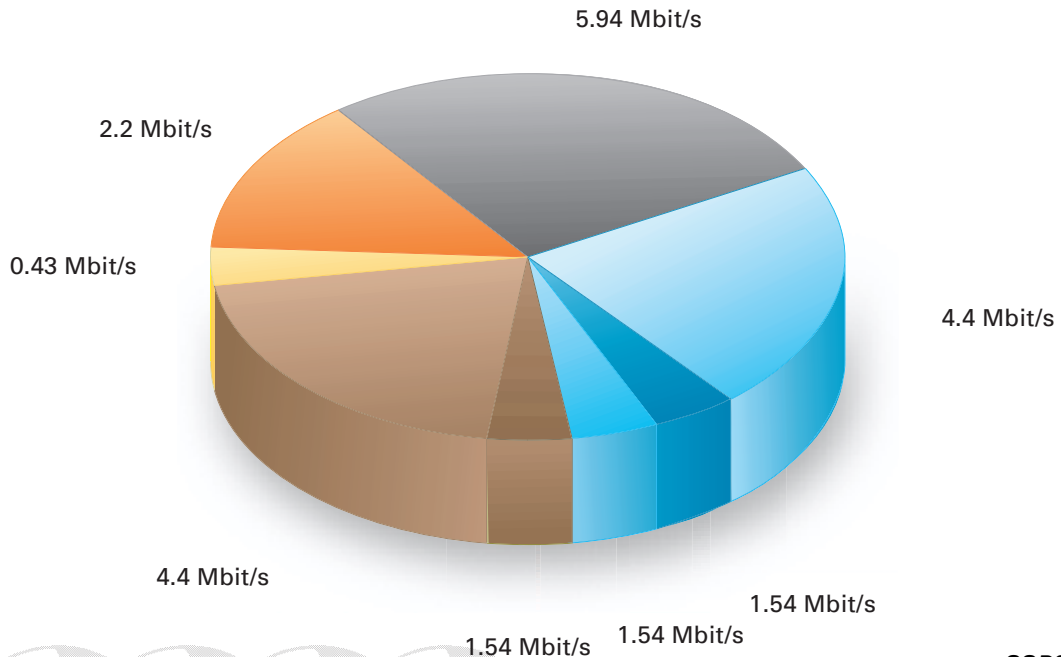

SSP286_010

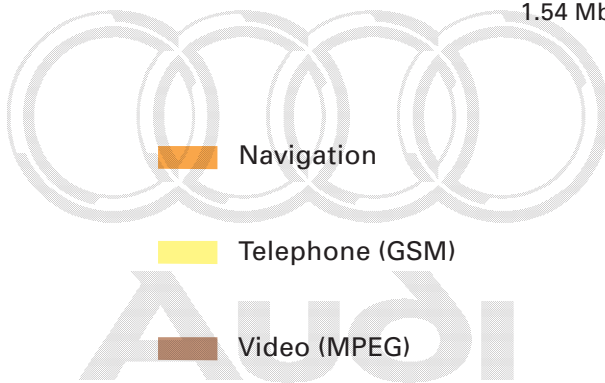

- Navigation
- Telephone (GSM)
- Video (MPEG)
- Audio source 1 (stereo)
e.g. via rear right headphones
- Audio source 2 (stereo)
e.g. via rear left headphones
- Audio source 3 (surround sound)
e.g. via digital sound system
- Not used

Protected by copyright. Copying for private or commercial purposes, in part or in whole, is not permitted unless authorized by Audi AG. Audi AG does not accept any liability with respect to the correctness of information in this document. Copyright by AUDI AG.



Optical data transfer is an appropriate means of implementing a complex infotainment system as the CAN data bus systems used to date cannot transmit data quickly enough and thus not in the volume required.

A transfer rate of roughly 6 Mbit/s is required just to transmit a digital TV signal with stereo sound.

The video and audio applications result in transfer rates of many Mbit/s.



The MOST bus permits transfer rates of 21.2 Mbit/s.

In the past such information (e.g. video and audio) could only be transmitted in the form of an analog signal, increasing the scope of harness wiring required.

CAN bus systems have a maximum data transfer rate of 1 Mbit/s. Consequently, it was only possible to use CAN bus systems to transmit the control signals.



SSP286_002

The optical MOST bus enables data to be exchanged between the components concerned in digital form.

In addition to fewer wires and less weight, light wave transmission provides a far higher data transfer rate.

In comparison to radio waves, light waves have very short wavelengths. In addition, they neither generate nor are susceptible to electromagnetic interference waves.

These factors permit a high data transfer rate and a high level of interference immunity.

Protected by copyright. Copying for private or commercial purposes, in part or in whole, is not permitted unless authorised by AUDI AG. AUDI AG does not guarantee or accept any liability with respect to the correctness of information in this document. Copyright by AUDI AG.



SSP286_003

MOST bus

Design of control units

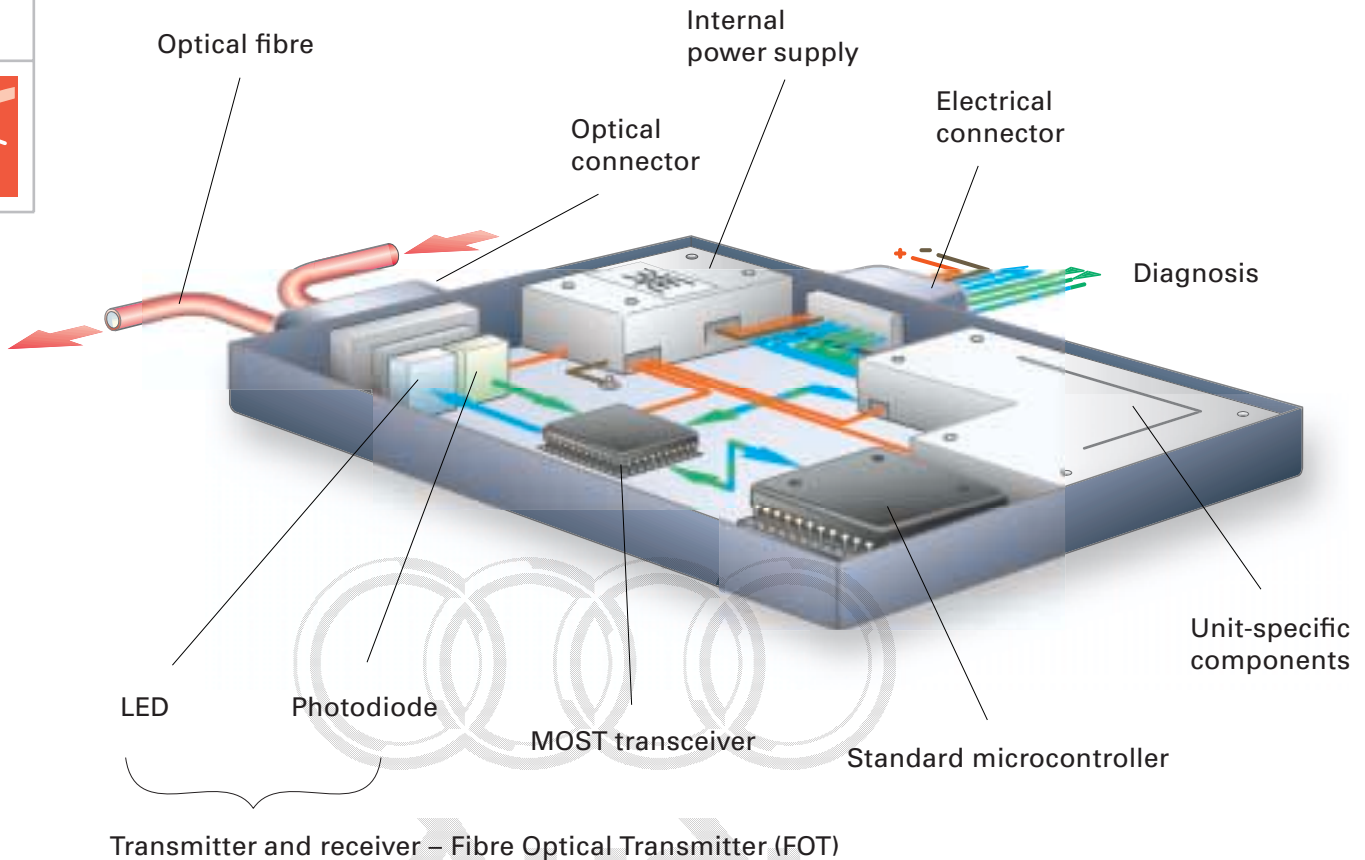

Transmitter and receiver – Fibre Optical Transmitter (FOT)

SSP286_011

Protected by copyright. Copying for private or commercial purposes, in part or in whole, is not permitted unless authorised by AUDI AG. AUDI AG does not guarantee or accept any liability with respect to the correctness of information in this document. Copyright by AUDI AG.

Components of control units in MOST bus

- Optical fibre - optical connector

By way of this connector, the light signals pass into the control unit or the light signals generated are conveyed to the next bus user.

- Electrical connector

This connector is responsible for the power supply, ring fault diagnosis (refer to Page 41 onwards) and input and output signals.

- Internal power supply

The supply voltage fed into the control unit by the electrical connector is distributed to the components by the internal power supply system. This enables individual components in the control unit to be deactivated to reduce closed circuit current.

- Transmitter and receiver – Fibre Optical Transmitter (FOT)

This consists of a photodiode and a light-emitting diode. Incoming light signals are converted by the photodiode into a voltage signal which is relayed to the MOST transceiver. The function of the light-emitting diode is to convert MOST transceiver voltage signals into light signals.

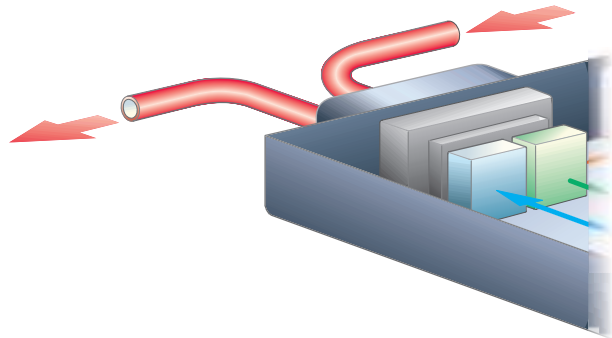

SSP286_063

The light waves generated have a wavelength of 650 nm and are visible as red light.

The data are transmitted by means of light wave modulation.

This modulated light is then conducted through the optical fibre to the next control unit.



- MOST transceiver

The MOST transceiver consists of two components, namely the **transmitter and receiver**.

The transmitter conveys the messages to be transmitted to the FOT in the form of a voltage signal.

The receiver accepts the voltage signals from the FOT and conveys the required data to the standard microcontroller (CPU) of the control unit.

Non-required messages from other control units pass through the transceiver without data being conveyed to the CPU. The messages are transmitted in unaltered form to the next control unit.

- Standard microcontroller (CPU)

The standard microcontroller (CPU) is the **central processing unit** of the control unit. It contains a microprocessor which controls all the major functions of the control unit.

- Unit-specific components

These components are responsible for the implementation of functions specific to the control unit, e.g. CD drive, radio tuner.



MOST bus

Photodiode

This is designed to convert the light waves into voltage signals.

Design

The photodiode has a p-n junction, onto which light can be focused. On account of a heavily doped p-layer, the depletion layer extends almost exclusively into the n-layer.

There is a contact (anode) at the p-layer. The n-layer is applied to the metallic base (cathode).

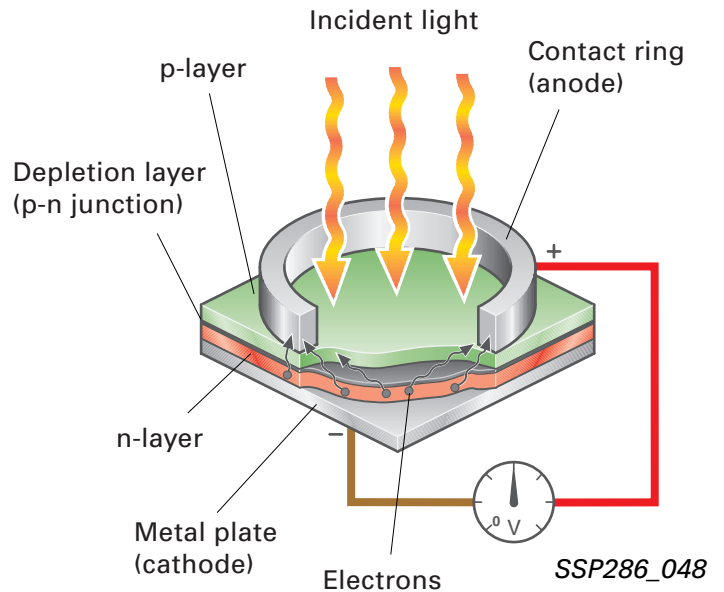

Function

The energy associated with the penetration of light or infrared rays into the p-n junction results in the formation of free electrons and holes. These give rise to a flow of current across the p-n junction.

Consequently, the more light which strikes the photodiode the higher will be the current flowing through it.

In reverse direction, the photodiode is connected in series with a resistor.

An increase in the current flowing through the photodiode on account of more light striking it increases the drop in voltage at the resistor. The light signal has thus been converted to a voltage signal.

This process is referred to as the **internal photoelectric effect**.

Protected by copyright. Copying for private or commercial purposes, in part or in whole, is not permitted unless authorised by AUDI AG. AUDI AG does not guarantee or accept any liability with respect to the correctness of information in this document. Copyright by AUDI AG.

Low incident light

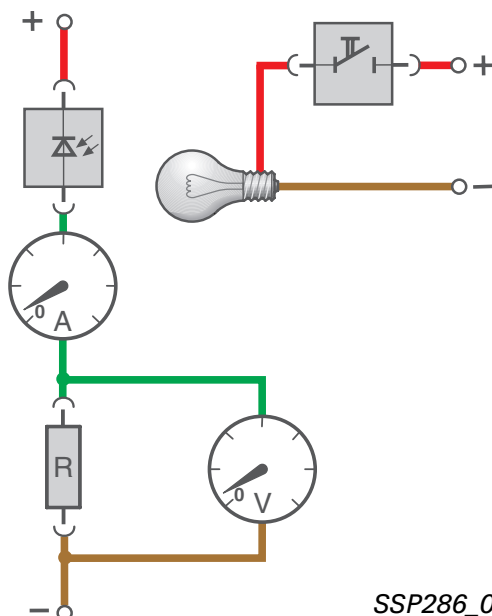

High incident light

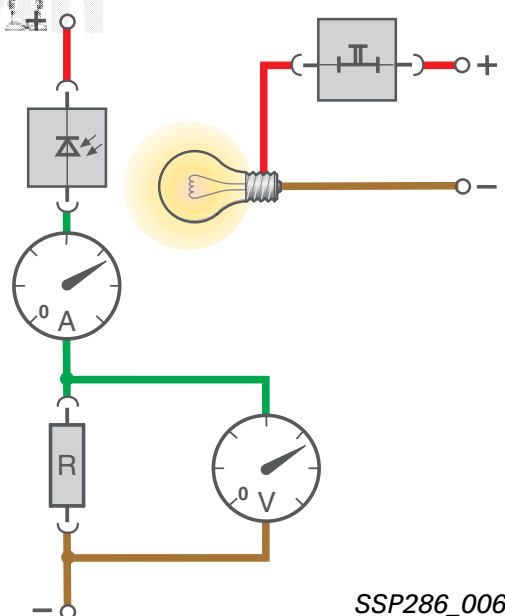

Optical fibre

The optical fibre is designed to convey the light waves generated in the transmitter of one control unit to the receiver of another control unit.

Development of the optical fibre was based on the following criteria:

- Light waves travel in straight lines and cannot be bent. However, they have to be routed through bends in the optical fibre.
- The distance between transmitter and receiver may be several metres – Attenuation (refer to Page 27).
- The optical fibre must not be susceptible to damage caused by mechanical impact (vibration, assembly work).
- The optical fibre must operate reliably despite the great temperature fluctuations in the vehicle.

Requirements to be met by optical fibres used for transmitting light signals:

- The optical fibre must conduct the light waves with a low level of attenuation.
- The light waves have to be routed through bends in the optical fibre.
- The optical fibre must be flexible.
- The optical fibre must operate reliably in the temperature range between - 40 °C and 85 °C.

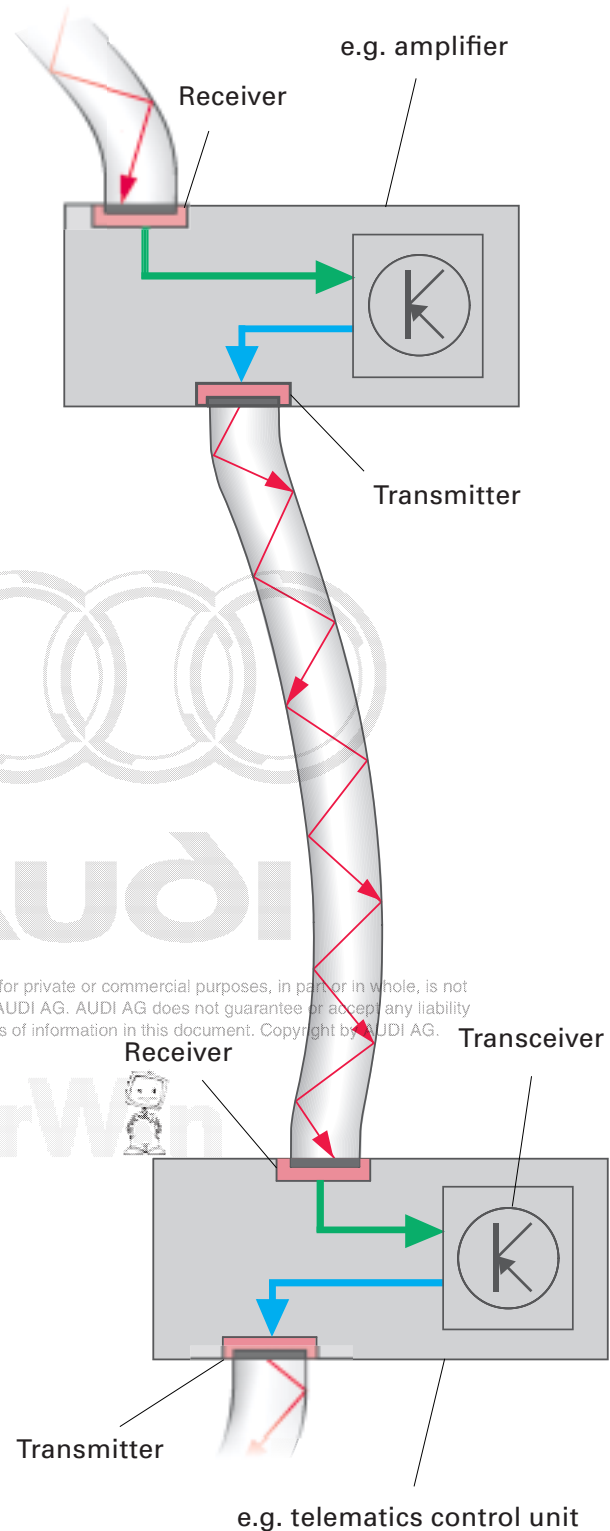

SSP286_020

MOST bus

Design of optical fibre

The optical fibre consists of several layers.

The core forms the central part of an optical fibre. It is made of polymethyl methacrylate and represents the actual light conductor, through which the light passes with virtually no losses by way of the total reflection principle. This principle is explained in greater detail in the following.

The optically transparent fluoropolymer cladding around the core is required for total reflection.

The black polyamide cladding protects the core against external incident light.

The coloured cladding is used for identification, protection against mechanical damage and thermal protection.

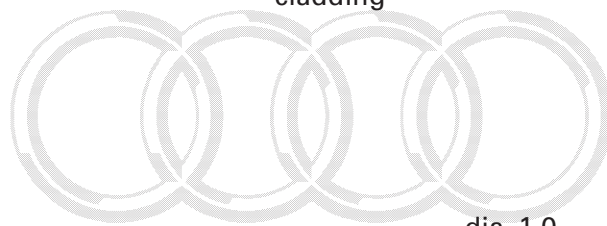
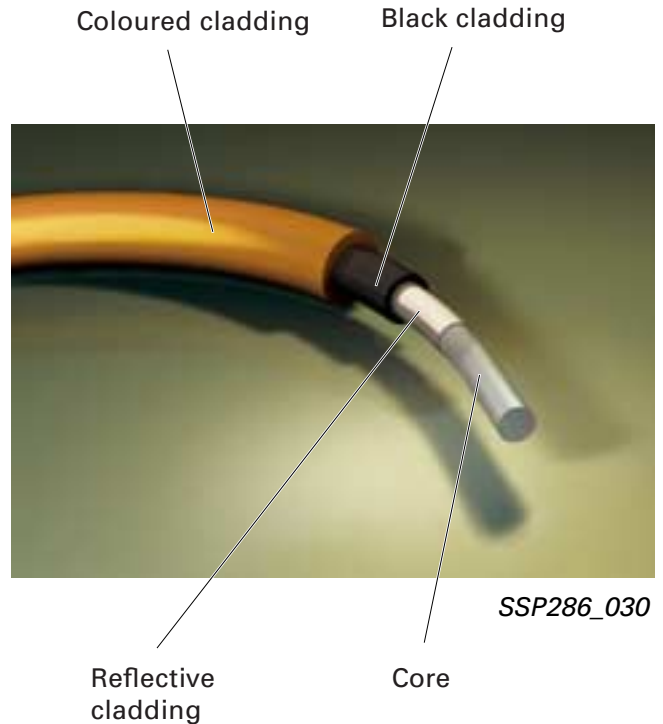

Audi

Protected by copyright. Copying for private or commercial purposes, in part or in whole, is not permitted unless authorised by AUDI AG. AUDI AG does not guarantee or accept any liability with respect to the correctness of information in this document. Copyright by AUDI AG.

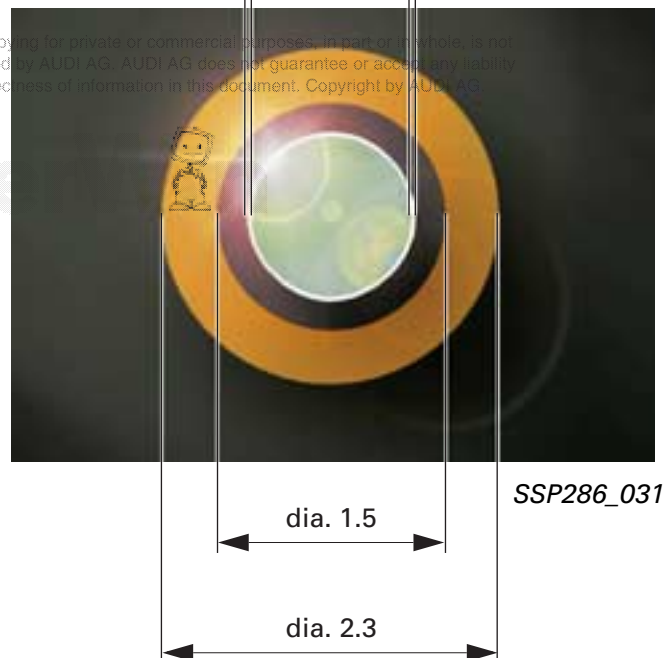

Transmission of light waves in optical fibre

Straight optical fibre

The optical fibre conducts some of the light waves in a straight line through the core.

Most of the light waves are conveyed in a zigzag pattern as a result of the total reflection occurring at the core surface.

Curved optical fibre

The total reflection occurring at the core cladding boundary causes the light waves to be reflected and thus conducted through the bend.

Total reflection

If a beam of light strikes a boundary layer between materials with higher and lower refractive indices at a shallow angle, the beam is fully reflected, i.e. total reflection takes place.

In an optical fibre, the material of the core has a higher refractive index than that of the cladding, with the result that total reflection takes place within the core.

This effect is governed by the angle of the light waves striking the boundary from inside. If this angle becomes too steep, the light waves will leave the core and high losses will occur.

This situation is encountered if the optical fibre is excessively bent or kinked.



The bending radius of the optical fibre must not be less than 25 mm.

Total reflection

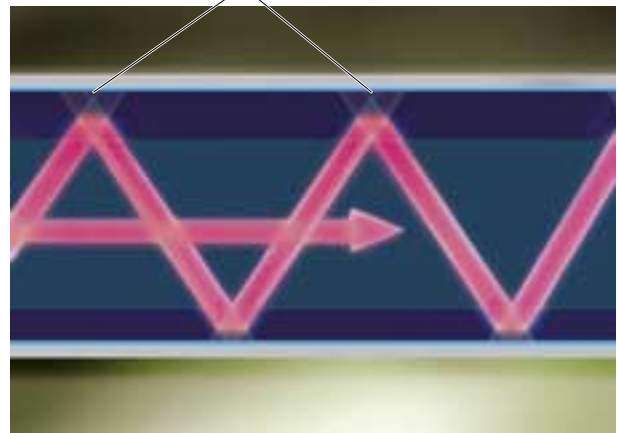

SSP286_032

Radius > 25 mm

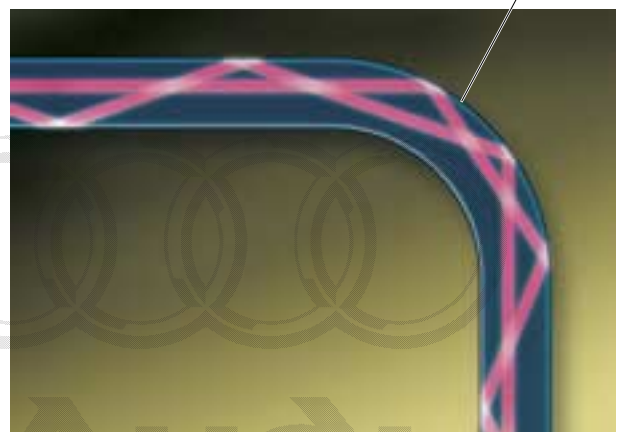

SSP286_033

Radius < 25 mm

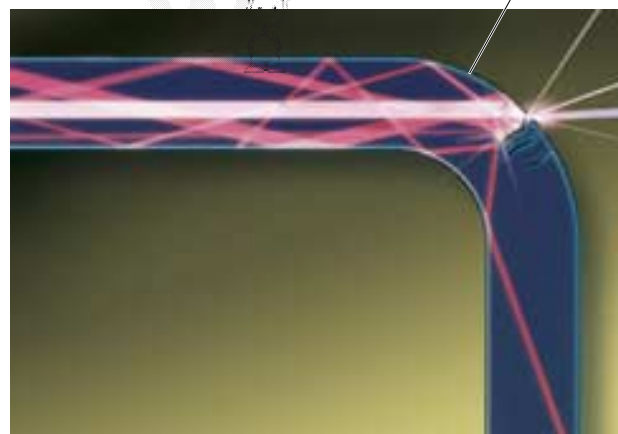

SSP286_034

Protected by copyright. Copying for private or commercial purposes, in part or in whole, is not permitted unless authorised by AUDI AG. AUDI AG does not guarantee or accept any liability with respect to the correctness of information in this document. Copyright © Audi AG



MOST bus

Connector

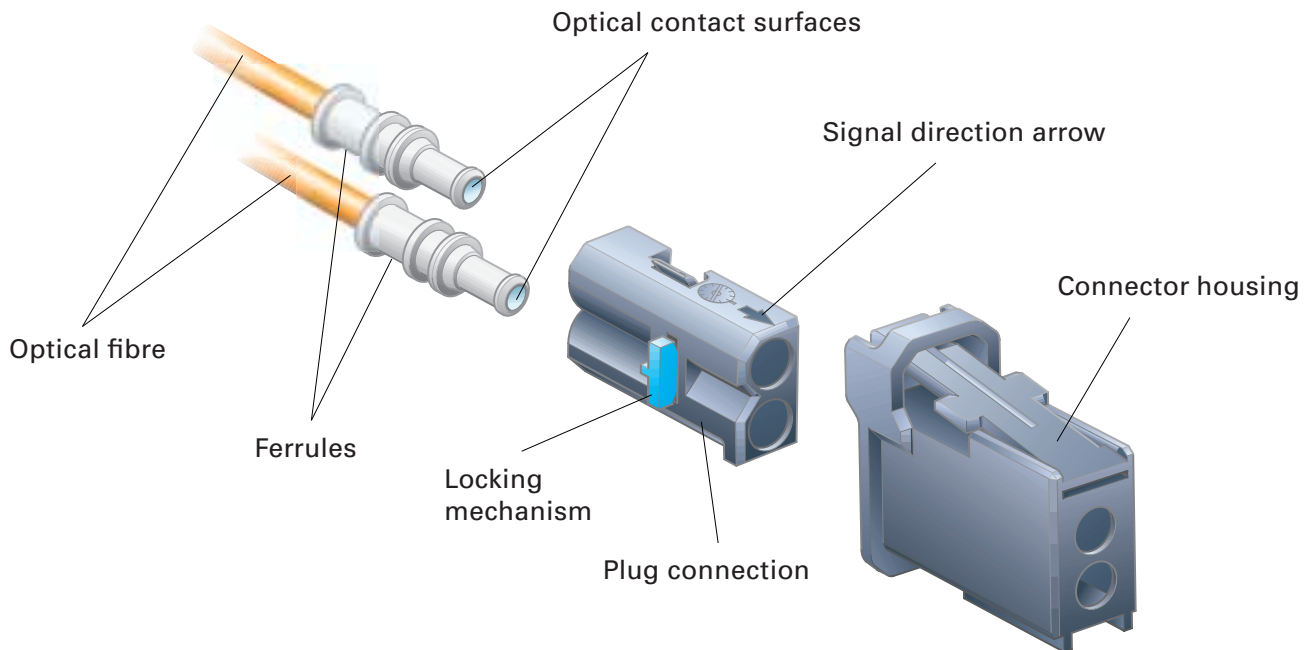

SSP286_035

Use is made of special optical connectors to link the optical fibres to the control units. A signal direction arrow on the plug connection indicates the input (to the receiver).

The connector housing creates the link with the control unit.

The light is transmitted by the end face of the core to the transmitter/receiver in the control unit.

At the optical fibre production stage, laser-welded plastic ferrules or crimp-type brass ferrules are fitted to secure the optical fibre in position in the connector housing.

Optical end face

To minimise transmission losses, the end face of the optical fibre must be

- smooth
- perpendicular and
- clean.

This can only be achieved using a special cutting tool.

Dirt and scratches on the cut face cause higher losses (attenuation).



Protected by copyright. Copying for private or commercial purposes, in part or in whole, is not permitted unless authorised by AUDI AG. AUDI AG does not guarantee or accept any liability with respect to the correctness of information in this document. Copyright © AUDI AG.



SSP286_081

Attenuation in optical bus

Assessment of the optical fibre condition involves measuring the attenuation.

A reduction in the power of the light waves during transmission is referred to as attenuation.

Attenuation (A) is given in decibels (dB).

A decibel is not an absolute quantity, but rather represents a ratio of two values.

This also explains why the decibel is not defined for specific physical quantities.

The decibel is also used, for example as a unit for expressing sound pressure or volume.

For attenuation measurement, this quantity is calculated from the logarithm of the ratio of transmission power to reception power.

Formula:

$$\text{Attenuation ratio (A)} = 10 * \lg \frac{\text{Transmission power}}{\text{Reception power}}$$

Example:

$$10 * \lg \frac{20 \text{ W}}{10 \text{ W}} = 3 \text{ dB}$$

This means that the light signal is reduced by half for an optical fibre with an attenuation ratio of 3 dB.

In other words, the higher the attenuation ratio, the poorer the signal transmission.

If several components are involved in the transmission of light signals, the attenuation ratios of the components can be added up to form a total attenuation ratio in the same way as the resistances of electrical components connected in series.

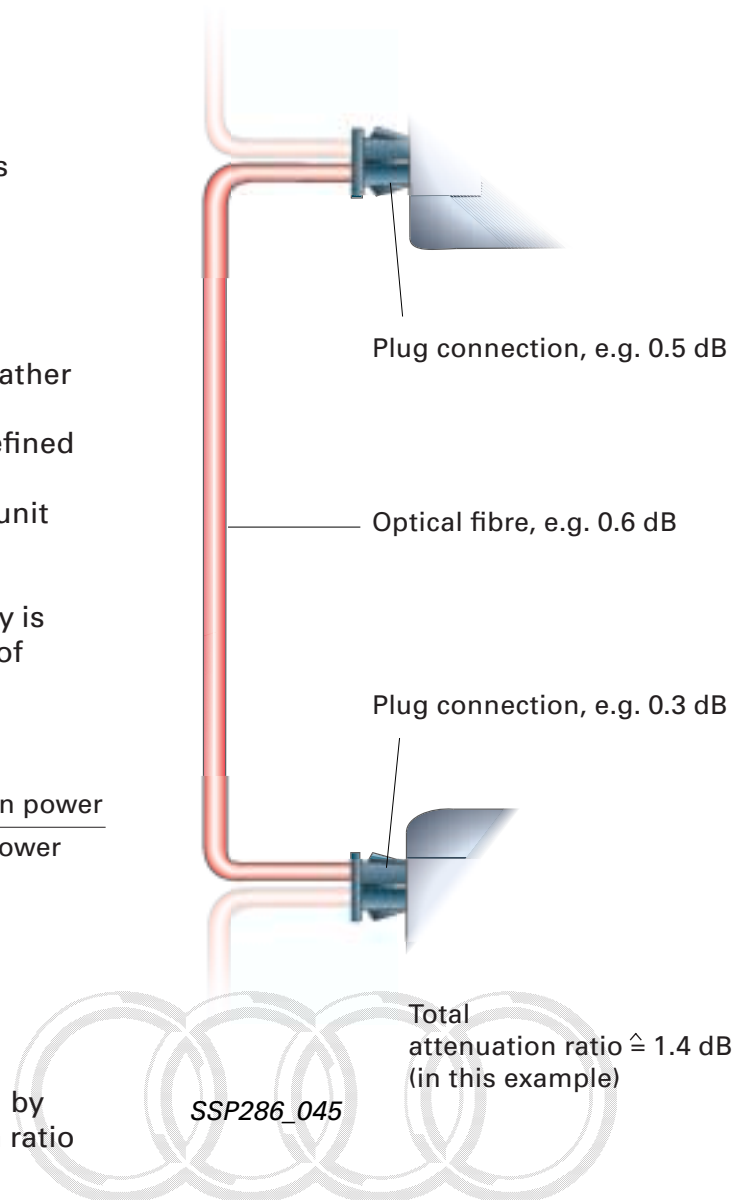

Protected by copyright. Copying for private or commercial purposes, in part or in whole, is not permitted unless authorised by AUDI AG. AUDI AG does not guarantee or accept any liability for the correctness of information in this document. Copyright by AUDI AG.

As in the MOST bus each control unit re-transmits the light waves, only the total attenuation ratio between two control units is of significance.

MOST bus

Causes of increased attenuation in the optical data bus

1. Optical fibre bending radius too small
Bending the optical fibre to a radius of less than 5 mm (kinking) obscures the core (comparable with bent perspex) at the bending point.
The optical fibre has to be replaced.
2. Damage to optical fibre cladding.
3. End face scratched.
4. End face dirty.
5. End faces offset
(connector housing broken).
6. End faces not in line
(angle error).
7. Gap between end face of optical fibre and contact surface of control unit
(connector housing broken or not engaged).
8. Ferrule not properly crimped.

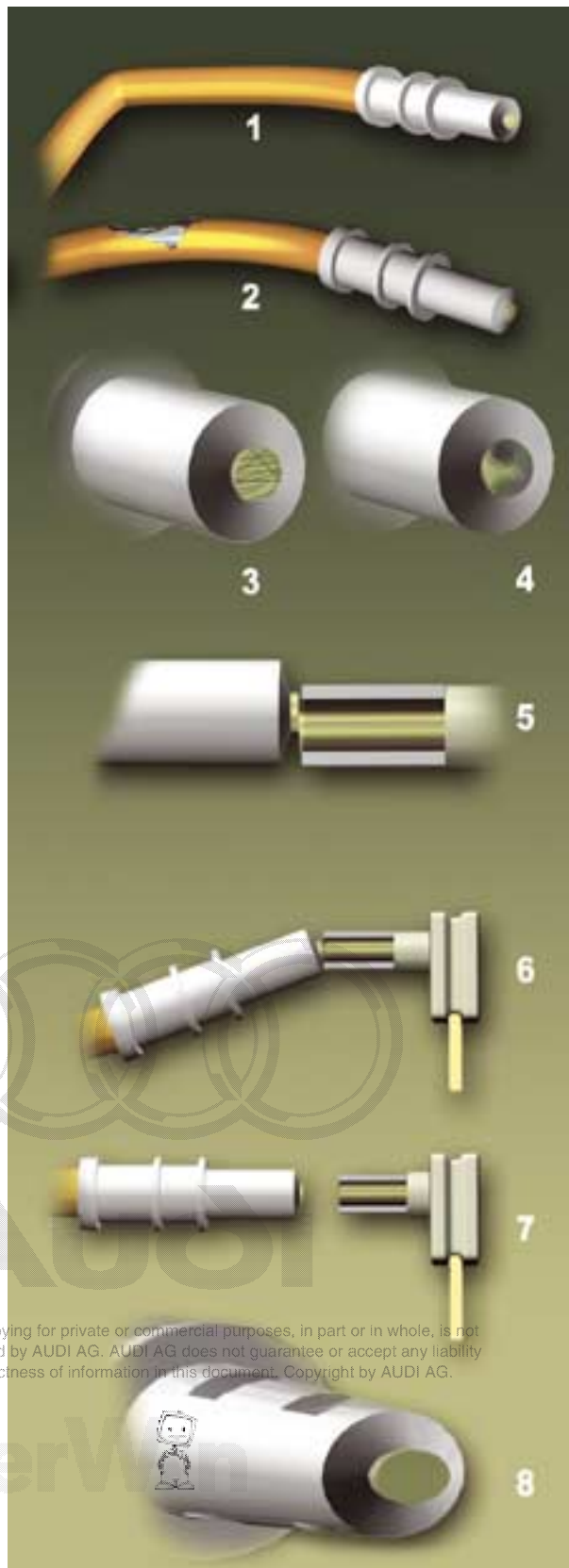

Protected by copyright. Copying for private or commercial purposes, in part or in whole, is not permitted unless authorised by AUDI AG. AUDI AG does not guarantee or accept any liability with respect to the correctness of information in this document. Copyright by AUDI AG.

Optical fibre anti-kink sleeve

Fitting an anti-kink sleeve guarantees a minimum optical fibre radius of 25 mm.



SSP286_087



Rules for handling optical fibres and their components

- Never employ thermal working and repair methods such as soldering, hot bonding or welding
- Never employ chemical and mechanical methods such as bonding and jointing
- Never twist together two optical fibre cables or an optical fibre cable and a copper wire
- Avoid cladding damage such as perforation, cutting or crushing: Do not stand or place objects on cladding, etc. when fitting in vehicle
- Avoid contaminating end face, e.g. with fluids, dust or other media; prescribed protective caps are only to be removed for connection or test purposes employing extreme care
- Avoid loops and knots when laying in vehicle; pay attention to correct length when replacing optical fibre

Audi

Protected by copyright. Copying for private or commercial purposes, in part or in whole, is not permitted unless authorised by AUDI AG. AUDI AG does not guarantee or accept any liability with respect to the correctness of information in this document. Copyright by AUDI AG.

erWin 

MOST bus

Ring configuration of MOST bus

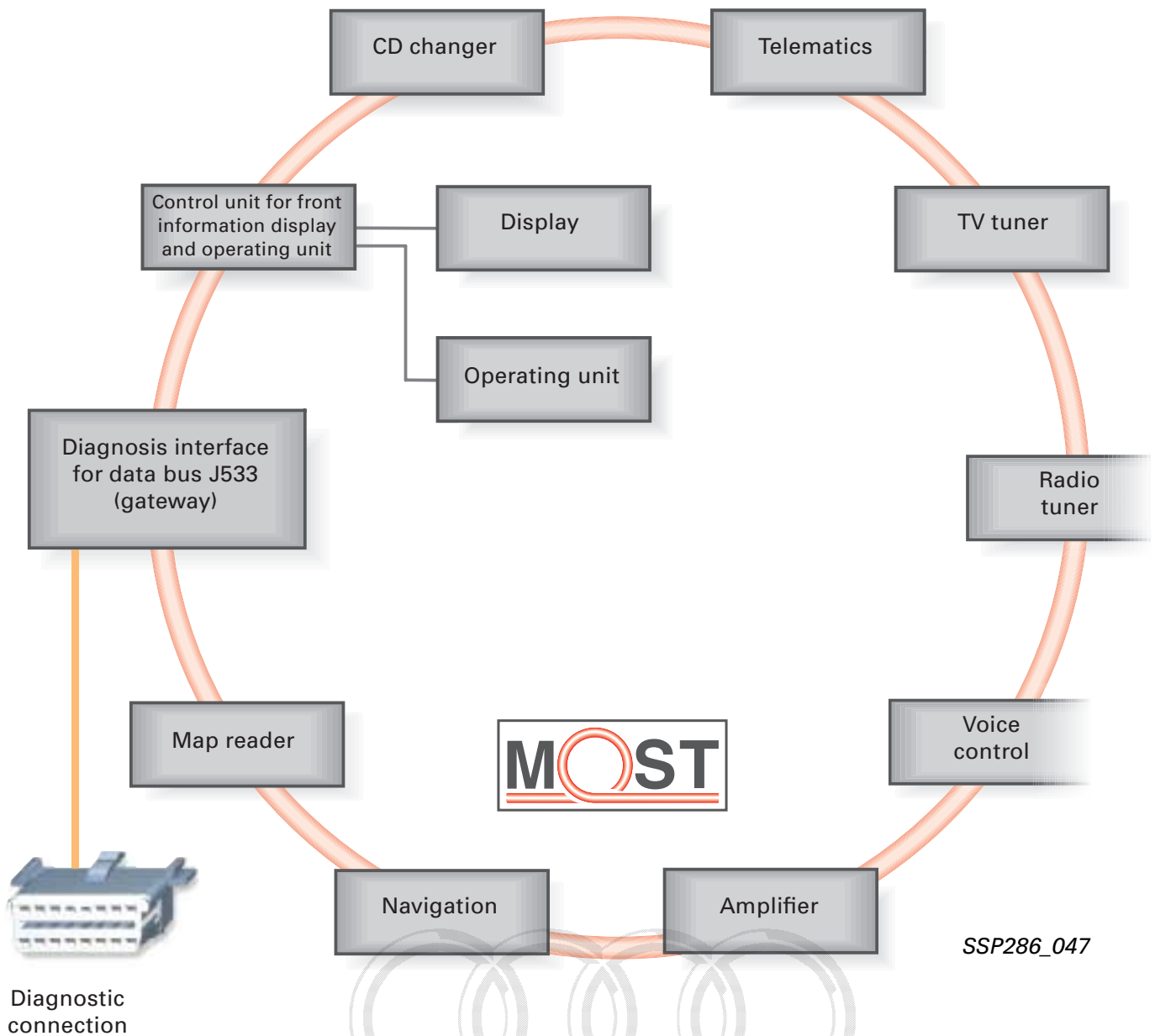

SSP286_047

A distinguishing feature of the MOST bus system is its ring configuration.

This completes the ring.

The control units transmit data in one direction via an optical fibre to the next control unit in the ring.

MOST bus system diagnosis is implemented by way of the data bus diagnosis interface and the diagnosis CAN.

This process continues until the data return to the control unit which originally transmitted them.

Protected by copyright. Copying for private or commercial purposes, in part or in whole, is not permitted unless authorised by AUDI AG. AUDI AG does not guarantee or accept any liability with respect to the correctness of information in this document. Copyright by AUDI AG.



System manager

Together with the diagnosis manager, the system manager is responsible for system administration in the MOST bus.

The diagnosis interface for data bus J533 (gateway) assumes the diagnosis manager functions in the Audi A8 '03 (refer to Page 41).

The control unit for front information display and operating unit J523 implements the system manager functions.

Functions of system manager:

- Control of system statuses
- Transmission of MOST bus messages
- Management of transmission capacities



MOST bus system statuses

Sleep mode

There is no data exchange in the MOST bus. The units are switched to standby and can only be activated by an optical start pulse from the system manager.

The closed-circuit current is reduced to a minimum.

Sleep mode activation conditions:

- All control units in MOST bus system indicate readiness to switch to sleep mode.
- No requests from other bus systems via the gateway.
- Diagnosis not active.

At a higher ranking level, the MOST bus system can be switched to sleep mode

- by the battery manager via the gateway in the event of starter battery discharge
- by activation of transport mode via the diagnosis tester



SSP286_066

Protected by copyright. Copying for private or commercial purposes, in part or in whole, is not permitted unless authorised by AUDI AG. AUDI AG does not guarantee or accept any liability for the accuracy or completeness of information in this document. Copyright by AUDI AG.



MOST bus

Standby mode

No functions are available to the user, i.e. the system gives the impression of being switched off. The MOST bus system is active in the background, however all output media (display, radio amplifier etc.) are either inactive or muted.

This mode is active on starting and during system run-on.

Activation of standby mode

- Activation by other data buses via gateway, e.g. unlocking/ opening of driver's door, ignition ON
- Activation by control unit in MOST bus, e.g. incoming call (telephone)



Power ON

The control units are fully activated. Data are exchanged on the MOST bus. All functions are available to the user.

Prerequisites for Power ON mode:

- MOST bus system in standby mode
- Activation by other data buses via gateway e.g. S-contact, display active
- Activation by user function selection, e.g. via multimedia operating unit E380

Further information on system status activation can be found in the Self Study Programmes for the appropriate vehicle models.



Frames

The system manager transmits the frames to the next control unit in the ring at a clock frequency of 44.1 kHz.

Clock frequency

On account of the fixed time slot pattern, the clock frequency permits the transmission of synchronous data.

Synchronous data are used to carry information such as sound and moving images (video) which always has to be transmitted at the same intervals.

The fixed clock frequency of 44.1 kHz corresponds to the transmission frequency of digital audio units (CD, DVD player, DAB radio) and thus permits the connection of these units to the MOST bus.

The magnitude of a frame is 64 bytes, divided up as indicated below.



Structure of a frame

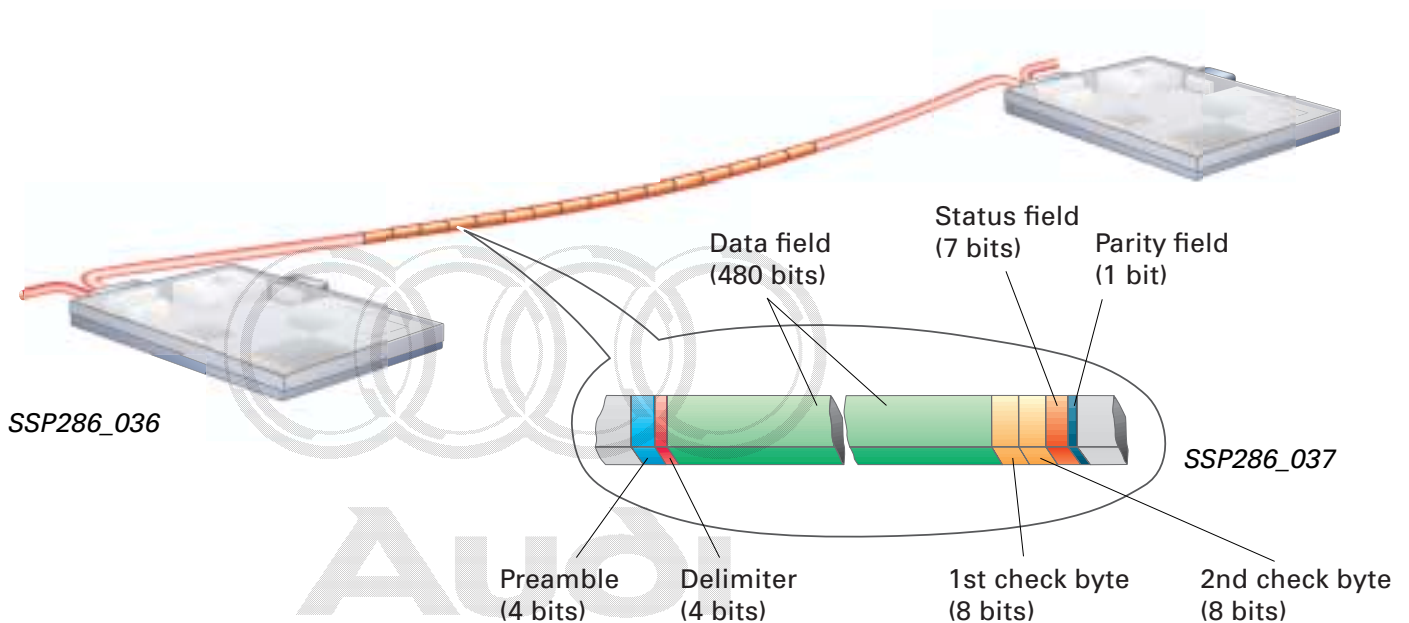

Protected by copyright. Copying for private or commercial purposes, in part or in whole, is not permitted unless authorised by AUDI AG. AUDI AG does not guarantee or accept any liability with respect to the correctness of information in this document. Copyright by AUDI AG.



1 byte corresponds to 8 bits.



MOST bus

Frame areas

The **preamble** marks the start of a frame. Each frame in a block has a separate preamble.



SSP286_039

A **delimiter** creates a clear distinction between the preamble and the subsequent data fields.



SSP286_040

The **data field** is used by the MOST bus to transmit up to 60 bytes of user data to the control units.

The asynchronous data are entered and thus transmitted to the receiver in packets of 4 bytes (quadlets) on the basis of the transmitter/receiver addresses (identifier) and the available asynchronous volume.

A distinction is made between two types of data:

- Audio and video in the form of synchronous data
- Images, information for calculation purposes and messages in the form of asynchronous data

The corresponding data transfer processes are described in more detail on Page 38 onwards.

The data field has a flexible structure. The proportion of synchronous data in the data field is between 24 and 60 bytes. The transmission of synchronous data has priority.

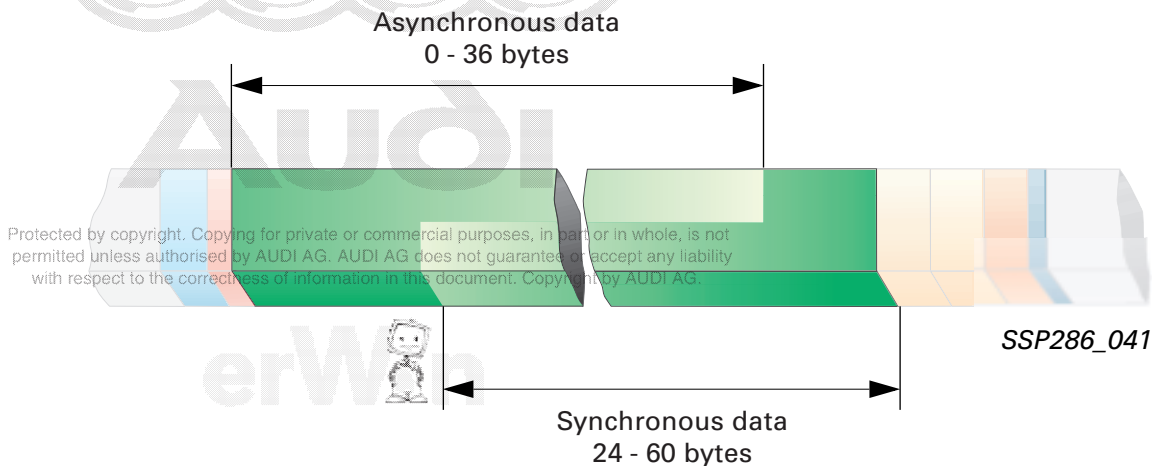

SSP286_041

The two **check bytes** are used to transmit information such as

- Transmitter and receiver address (identifier)
- Control commands to receiver (e.g. amplifier setting up/down)

The block **check bytes** are assembled in the control units to form a check frame. One block consists of 16 frames. The check frame contains control and diagnosis data to be transferred from a transmitter to a receiver. This is referred to as address-oriented data transfer.

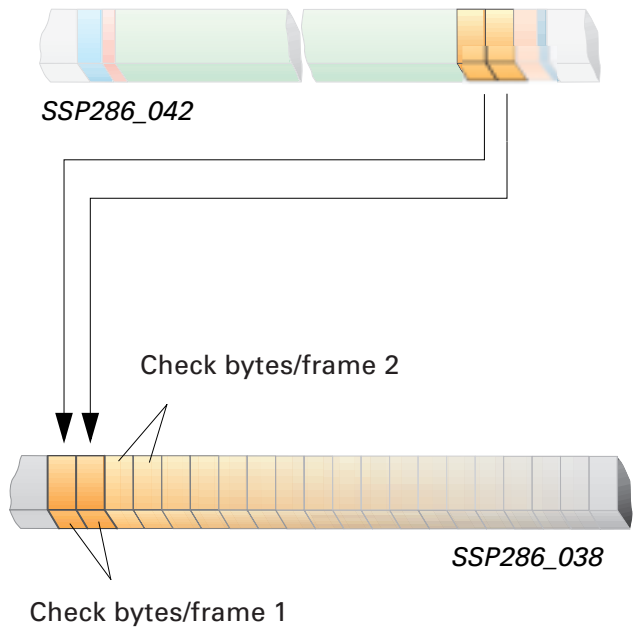

Example:

Transmitter – Control unit for front information display and operating unit

Receiver – Amplifier

Control signal – up/down

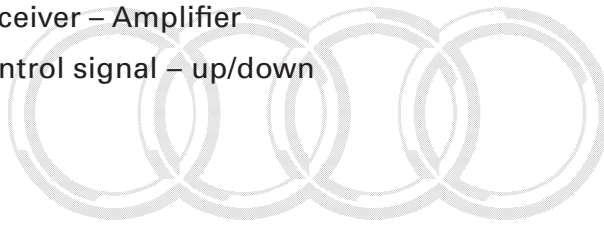

The **status field** of a frame contains frame transmission information for the receiver.



Protected by copyright. Copying for private or commercial purposes, in part or in whole, is not permitted unless authorised by AUDI AG. AUDI AG does not guarantee or accept any liability with respect to the correctness of information in this document. Copyright by AUDI AG.

The **parity field** is used for a final check that the frame is complete. The content of this field governs whether a transmission process is repeated.



MOST bus

Operating sequences in MOST bus

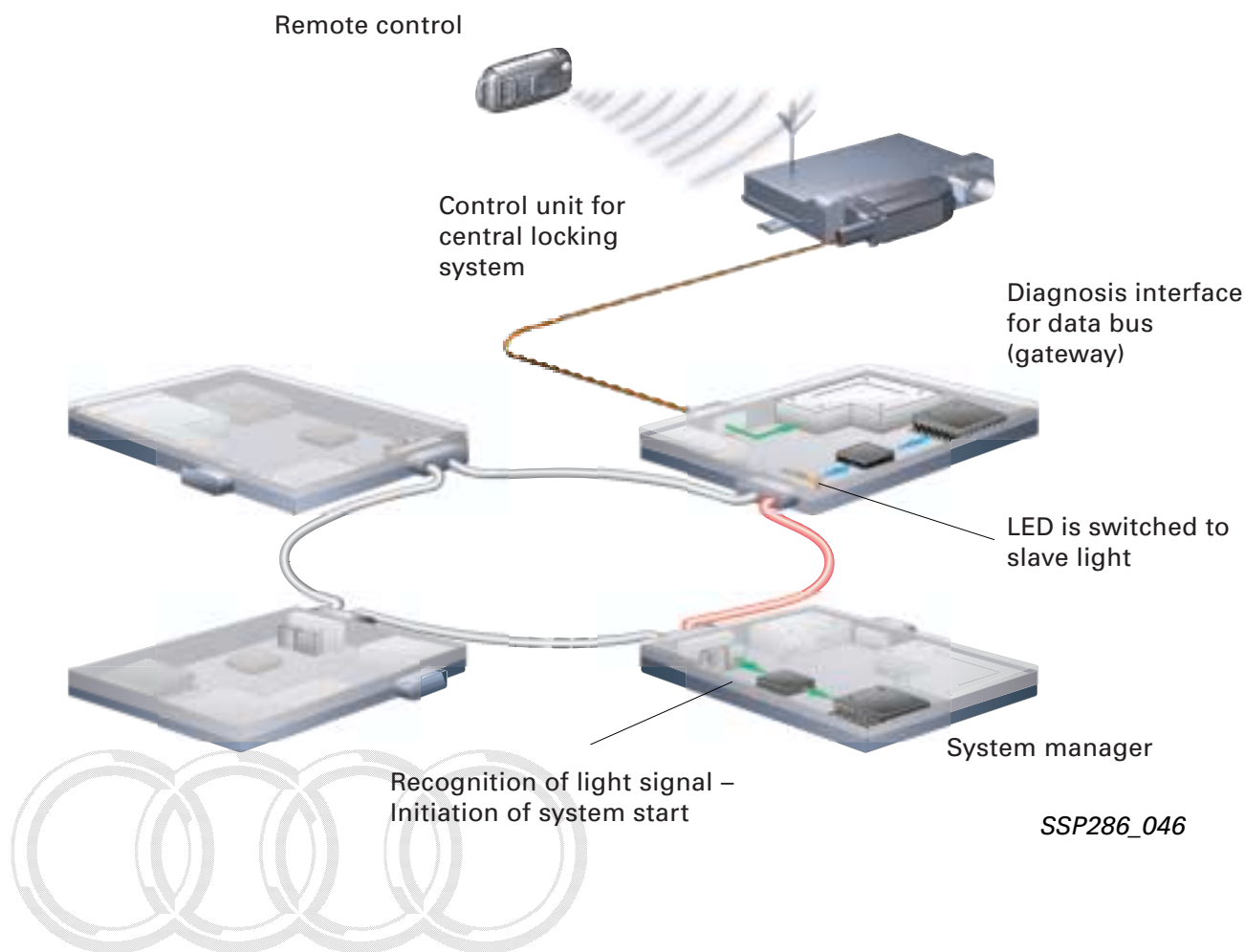

System start (wake-up)

If the MOST bus is in sleep mode, the wake-up process initially switches the system to standby mode.

If one of the control units, with the exception of the system manager, wakes the MOST bus, it transmits specially modulated light – slave light – to the next control unit.

By way of the photodiode which is active in sleep mode, the next control unit in the ring receives the slave light and passes it on.

This process continues right through to the system manager. In the incoming slave light the manager recognises the prompt for system starting.

The system manager then transmits another specially modulated light – master light – to the next control unit. This master light is relayed by all control units. Reception of the master light in its FOT informs the system manager that the ring is complete and frame transmission commences.

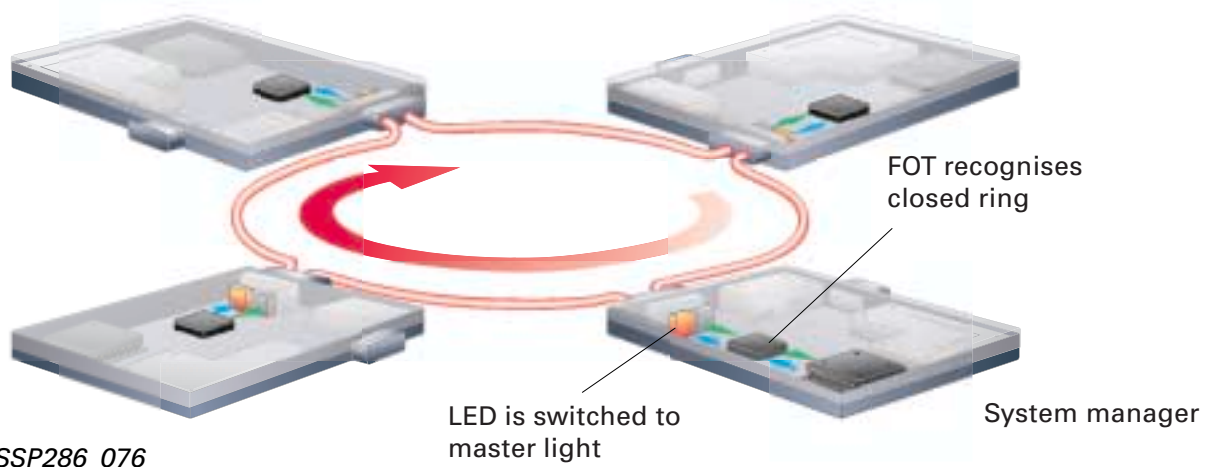

In the first frames the control units in the MOST bus are requested to provide identification.

Based on the identification, the system manager transmits the current sequence (actual configuration) to all control units in the ring. This permits address-oriented data transfer.

The diagnosis manager compares the reported control units (actual configuration) to a stored list of control units fitted (specified configuration).

If the actual and specified configurations do not coincide, the diagnosis manager stores corresponding fault memory entries.

This completes the wake-up process and data transfer can commence.



Protected by copyright. Copying for private or commercial purposes, in part or in whole, is not permitted unless authorised by AUDI AG. AUDI AG does not guarantee or accept any liability with respect to the correctness of information in this document. Copyright by AUDI AG.

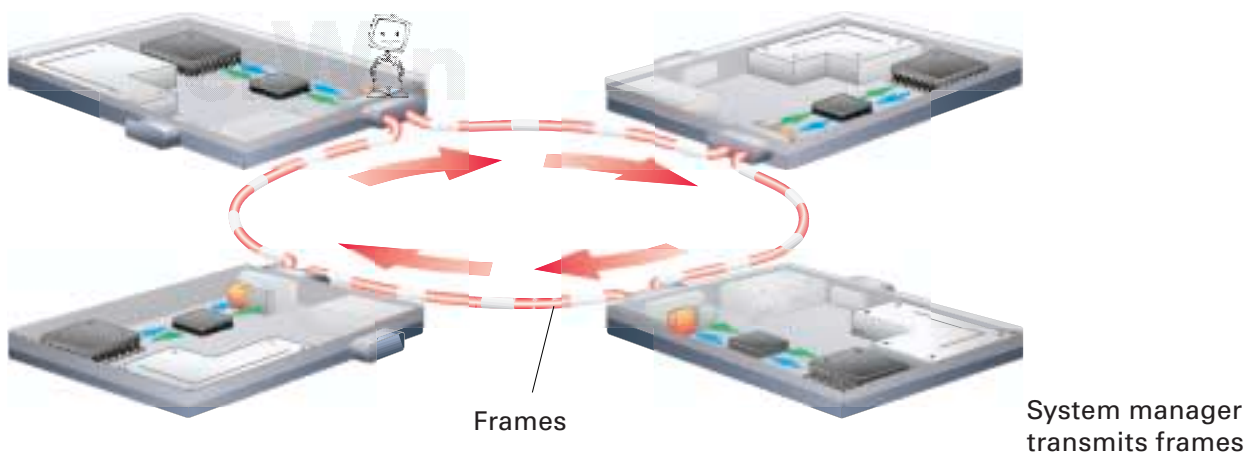

MOST bus

Audio and video transmission in the form of synchronous data

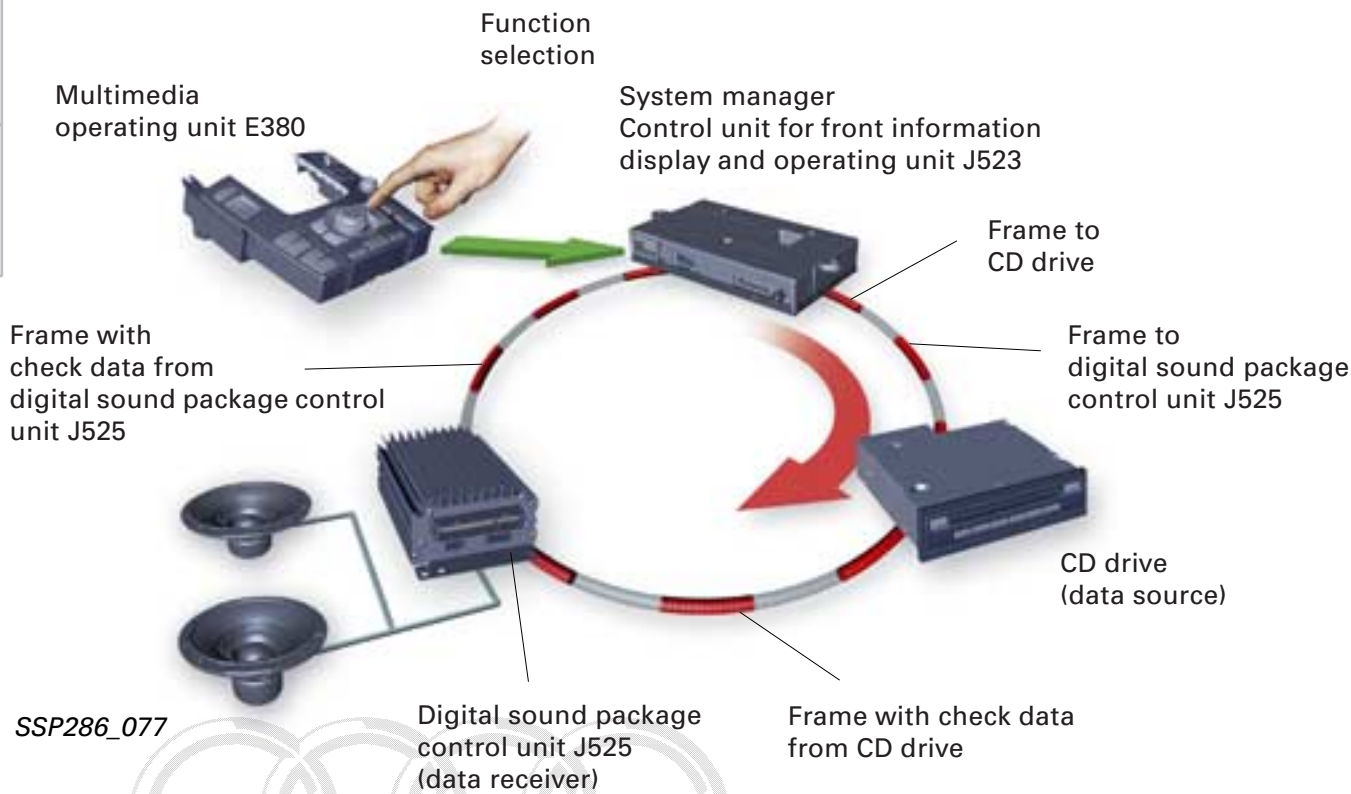

By way of explanation, synchronous data transfer is described on the basis of the mode of operation involved in playing a music CD in the Audi A8 '03.

With the aid of the multimedia operating unit E380 and the information display unit J685, the user selects the desired track on the music CD.

By way of a data wire, the operating unit E380 transmits the control signals to the control unit for front information display and operating unit J523 (system manager). Corresponding information can be found in the Self Study Programme 293 – Audi A8 '03 Infotainment.

The system manager then inserts a message block (= 16 frames) with the check data into the frames constantly transmitted.

- Transmitter address:
 - Control unit for front information display and operating unit J523, position 1 in ring

- Receiver address of data source:
 - CD drive, position in ring (depends on equipment)

- Control commands:
 - Play track 10
 - Assign transmission channels

The CD drive (data source) determines which bytes in the data field are available for transmitting its data.

It then inserts a block with the check data.

- Transmitter address of data source:
 - CD drive, position in ring (depends on equipment)
- Receiver address of system manager:
 - Control unit for front information display and operating unit J523, position 1 in ring
- Control command:
 - Data transfer/music CD on channels 01, 02, 03, 04 (stereo))

Data management with synchronous transmission

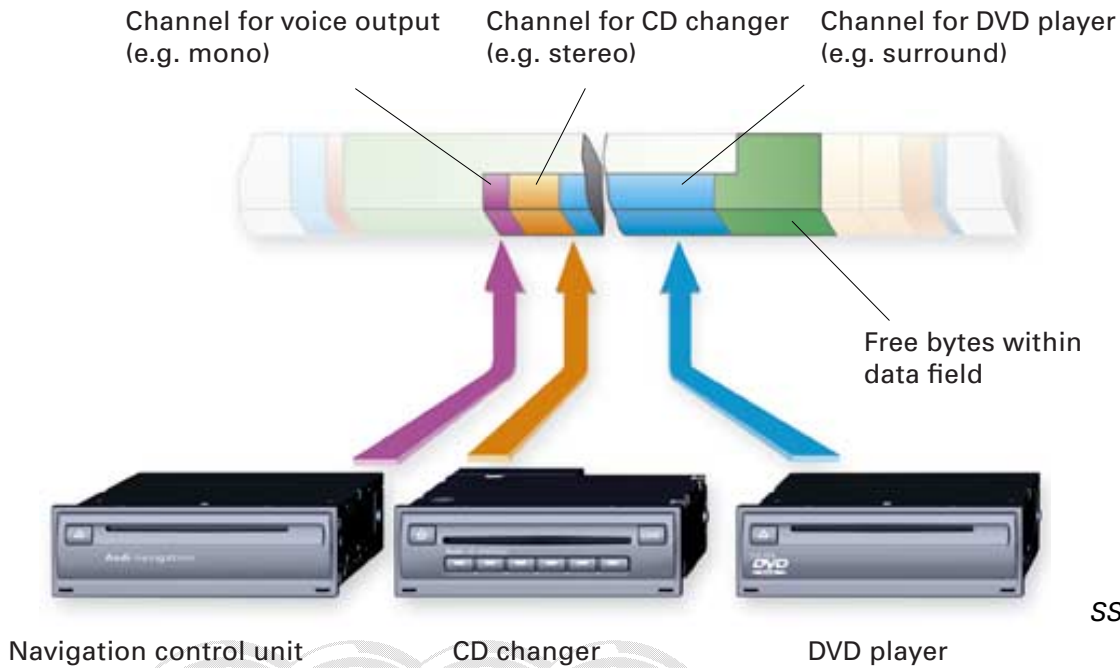

The control unit for front information display and operating unit J523 then uses a block with the check data

This permits use of the synchronous data by all output units (sound package, headphone connections) in the MOST bus.

- Transmitter address:
 - Control unit for front information display and operating unit J523, position 1 in ring
- Receiver address:
 - Digital sound package control unit J525, position in ring (depends on equipment)
- Control commands:
 - Read out data channels 01, 02, 03, 04 and reproduce via speakers
 - Current sound settings such as volume, fader, balance, bass, treble, middle
 - Deactivate muting

The system manager determines which unit is to use the data by transmitting the corresponding check data.

Transmission channels

Audio and video transmission requires several bytes in each data field. The data source reserves a number of bytes in line with the type of signal. The bytes reserved are referred to as channels. One channel contains one byte of data.

Number of transmission channels

Signal	Channels/bytes
Mono	2
Stereo	4
Surround	12

to issue the instruction to the digital sound package control unit J525 (data receiver) to reproduce the music.

The music CD data are retained in the data field until the frame reaches the CD drive (i.e. the data source) again via the ring. The data are then replaced by fresh data and the cycle commences again.

This reservation of channels permits the simultaneous transmission of synchronous data from several data sources.



MOST bus

Transmission of data for images, messages and functions in the form of asynchronous data

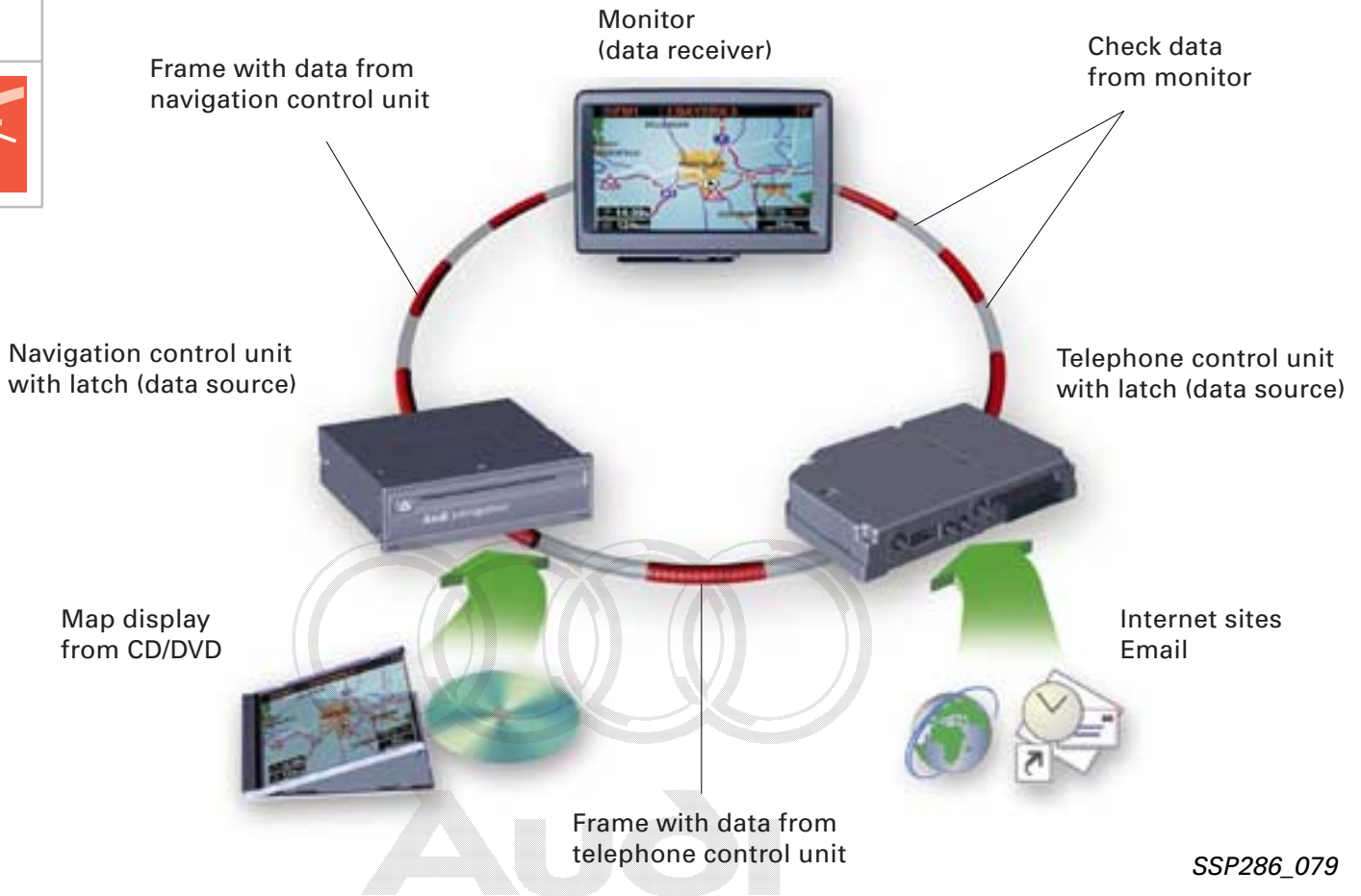

SSP286_079

Protected by copyright. Copying for private or commercial purposes, in part or in whole, is not permitted unless authorised by AUDI AG. AUDI AG does not guarantee or accept any liability with respect to the correctness of information in this document. Copyright by AUDI AG.

The data for

- Navigation system map display
- Navigation calculations
- Internet sites
- Email

are transmitted in the form of asynchronous data.

The asynchronous data sources transmit at irregular intervals.

For this purpose, each source stores its asynchronous data in a latch.

The data source then waits until it receives a message block with the address of the receiver.

The source enters the data into the free bytes in the data fields of this message block.

This takes place in packets (quadlets) of 4 bytes each.

The receiver reads the data packets in the data fields and processes the information.

The asynchronous data are retained in the data fields until the message block returns to the data source.

The data source extracts the data from the data fields and replaces them with fresh data if applicable.



Diagnosis

Diagnosis manager

In addition to the system manager, the MOST bus also has a diagnosis manager.

This is responsible for ring fault diagnosis and transmits the diagnosis data of the control units in the MOST bus to the diagnosis unit.

In the Audi A8 '03, the diagnosis interface for data bus J533 implements the diagnostic functions.



SSP286_057



System malfunction

On account of the ring configuration, interruption of data transfer at a given MOST bus location is referred to as a ring break.

Ring fault diagnosis must be performed to localise a break in the ring.

Ring fault diagnosis is part of the final control diagnosis routine of the diagnosis manager.

Possible causes of break in ring:

- Break in optical fibre
- Fault in power supply of transmitter or receiver control unit
- Defective transmitter or receiver control unit

Consequences of break in ring:

- No audio and video reproduction
- No control and adjustment by way of multimedia operating unit
- Entry in diagnosis manager fault memory ("Break in optical data bus")

Ring fault diagnosis

Ring fault diagnosis wire

As a break in the ring prevents data transfer in the MOST bus, ring fault diagnosis is implemented with the aid of a diagnosis wire.

The diagnosis wire is linked by way of a central wiring connection to each MOST bus control unit.

Protected by copyright. Copying for private or commercial purposes, in part or in whole, is not permitted unless authorised by AUDI AG. AUDI AG does not guarantee the accuracy of any information with respect to the correctness of information in this document.



MOST bus

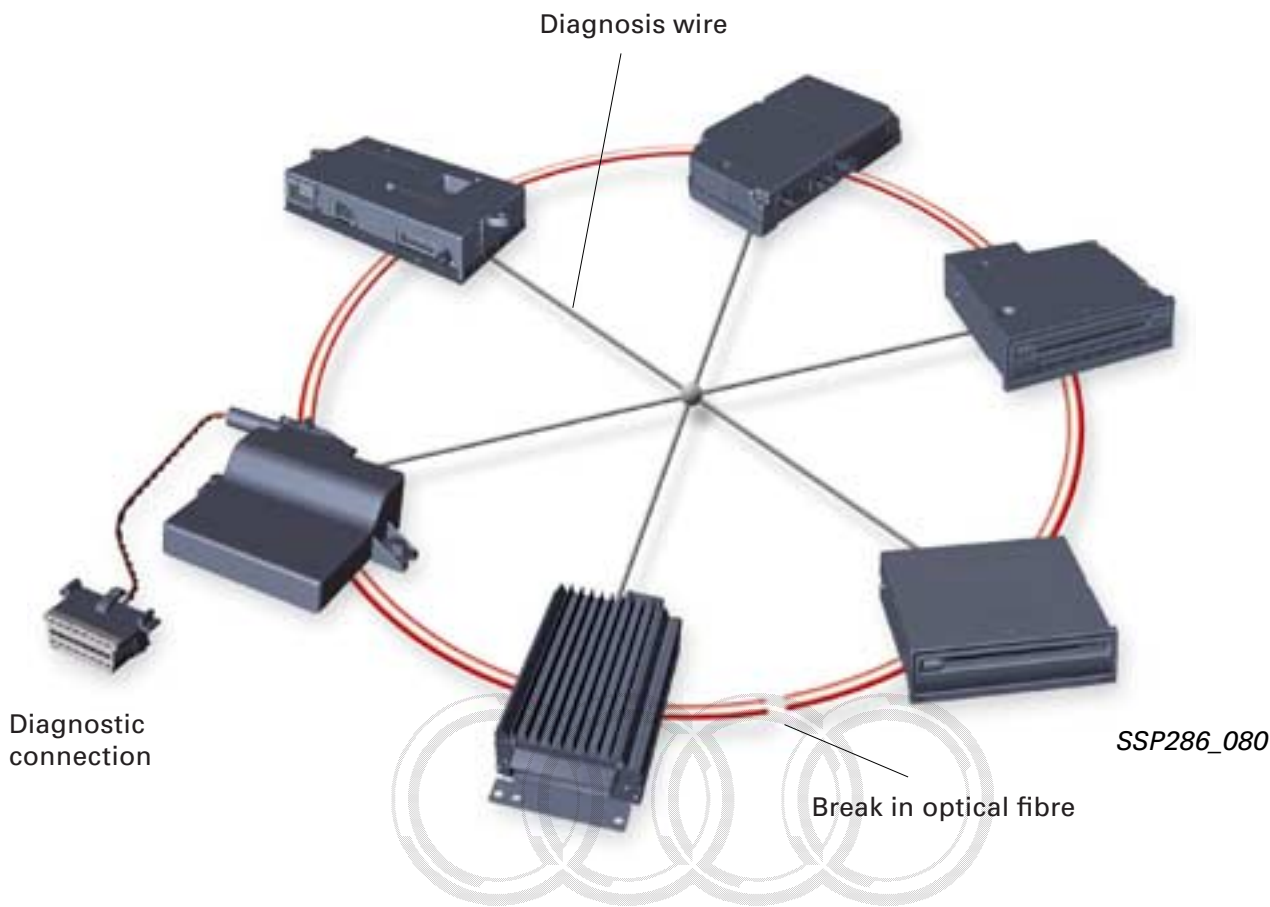

After starting ring fault diagnosis, the diagnosis manager transmits a pulse via the diagnosis wire to the control units.

This pulse causes all control units to transmit light signals with the aid of their transmission unit in the FOT.

In this process, all control units check

- their power supply and internal electrical functions.
- Reception of light signals from preceding control unit in ring.

Each MOST bus control unit responds following a time period stipulated in its software.

The time period between start of ring fault diagnosis and control unit response enables the diagnosis manager to recognise which control unit has transmitted the response.

Content of response

Following start of ring fault diagnosis, the MOST bus control units transmit two items of information:

1. Control unit in proper electrical working order – i.e. electrical functions of control unit (e.g. power supply) are OK
2. Control unit in proper optical working order – its photodiode receives the light signal from the preceding control unit in the ring

These messages inform the diagnosis manager

- of any electrical faults in the system (fault in power supply)
- or of the control units between which there is a break in optical data transfer.

Protected by copyright. Copying for private use only is permitted, unless authorised by AUDI AG. AUDI AG does not guarantee or accept any liability with respect to the correctness of information in this document. Copyright by AUDI AG.

Ring fault diagnosis with increased attenuation

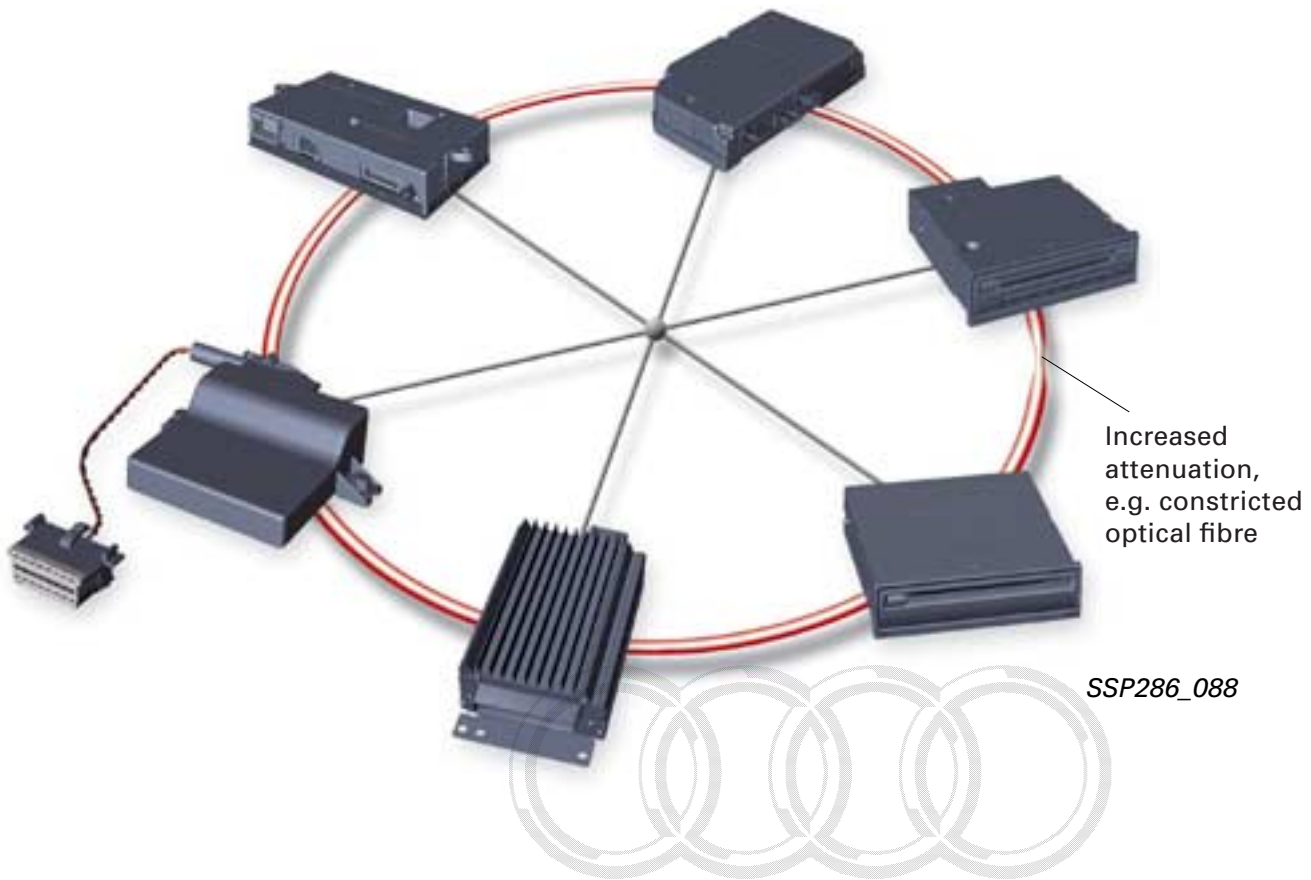

Ring fault diagnosis only permits detection of a break in data transfer.

The final control diagnosis function of the diagnosis manager additionally contains ring fault diagnosis with reduced light power for detection of increased attenuation.

The ring fault diagnosis process with reduced power corresponds to that described above.

However, the control units switch on their LEDs in the FOT with an attenuation of 3 dB, i.e. with light power reduced by half.

If the optical fibre is subject to increased attenuation, the light signal reaching the receiver is of insufficient strength. The receiver signals "optical problem".

The diagnosis manager thus recognises the fault location and issues a corresponding message in the assisted fault-finding of the diagnosis tester.



Introduction



SSP286_085

Audi

Protected by copyright. Copying for private or commercial purposes, in part or in whole, is not permitted unless authorised by AUDI AG. AUDI AG does not guarantee or accept any liability with respect to the correctness of information in this document. Copyright by AUDI AG.

Mobile communication and information are gaining in importance in both the modern business world and the private sector.

For example, it is not unusual for one person to use several mobile systems such as mobile phone, Personal Digital Assistant (PDA) or notebook.

In the past, the exchange of information between mobile systems required the use of a hard wire or infrared techniques.

Such non-standardised links greatly restricted mobility or were complicated to use.

Bluetooth™ technology provides the solution by creating a standardised radio link for connecting mobile systems from different manufacturers.

This technique is to be introduced for the first time in the Audi A8 '03 to provide a wireless link between the telephone handset and the control unit for telephone/telematics.

Additional applications for the vehicle user are planned for the future:

- Installation of second handset at rear of vehicle
- Connection of notebooks, smart phones and notepads to the internet for information transmission and entertainment
- Reception and transmission of emails via user's notebook or PDA
- Transmission of addresses and telephone numbers from user's notebook or PDA to Multimedia Interface (MMI) system
- Hands-free unit for mobile phones with no additional cable adapters
- Use of Bluetooth™ technology in other vehicle systems
(example: remote control for auxiliary heating)



What is Bluetooth™?

The Swedish company Ericsson proposed the development of a standardised short-range wireless system – Bluetooth™ technology.

Several other companies decided to join in with this project and today the Bluetooth Special Interest Group (SIG) includes some 2000 companies from the fields of telecommunications, data processing and equipment and vehicle manufacturing.

The name "Bluetooth" originates from the Viking king Harald Blåtand, who unified Denmark and Norway in the tenth century and was known by the nickname "Blue tooth".



Protected by copyright. Copying for private or commercial purposes, in part or in whole, is not permitted unless authorised by AUDI AG. AUDI AG does not guarantee or accept any liability with respect to the correctness of information in this document. Copyright by AUDI AG.



As this system combines a wide range of different information, data processing and mobile phone systems it reflects the philosophy of king Harald and thus came to be known as Bluetooth™.

Operation

Design

Short-range transceivers (transmitters and receivers) are either installed directly in selected mobile units or integrated by way of an adapter (e.g. PC card, USB).

Communication takes place in the 2.45 GHz frequency band which is freely available worldwide.

The extremely short wavelength of this frequency permits integration of

- Aerial
- Control and encoding
- Entire transmission and reception system

into the Bluetooth™ module.

The compact design of the Bluetooth™ module makes it suitable for installation even in miniature electronic devices.



SSP286_082

The data transfer rate is up to 1 Mbit/s. The units can transmit up to three voice channels simultaneously.

Bluetooth™ transmitters have a range of ten metres. Up to 100 metres can be achieved with an additional amplifier for special applications.

Data transfer does not require any complicated settings.

A link is automatically established between any two Bluetooth™ units entering into contact with one another. Before this can occur, once-only matching of the units has to be implemented by entering a PIN. Information on the procedure involved can be found in SSP 293 – Audi A8 Infotainment.

This involves the creation of miniature wireless cells known as "Piconet" for organisational purposes.

One piconet provides space for a maximum of eight active Bluetooth™ units, however each unit may form part of several picocells at the same time. In addition, up to 256 non-active units can be assigned to one piconet.

One unit assumes the master function in each piconet:

- The master establishes the link.
- The other units are synchronised with the master.
- Only the unit receiving a data packet from the master can transmit a response.

Example:

In the Audi A8 '03, the telephone/telematics control unit is the Bluetooth™ master.

To avoid chaos when creating a piconet, **settings can be made on each unit to determine the unit with which it is allowed to communicate or not.**

Each unit has a unique worldwide address with a length of 48 bits, thus permitting unequivocal identification of more than 281 billion units.

Protected by copyright. All rights reserved. Audi AG does not guarantee or accept any liability with respect to the correctness of this technical document. Copyright by Audi AG.

Operation

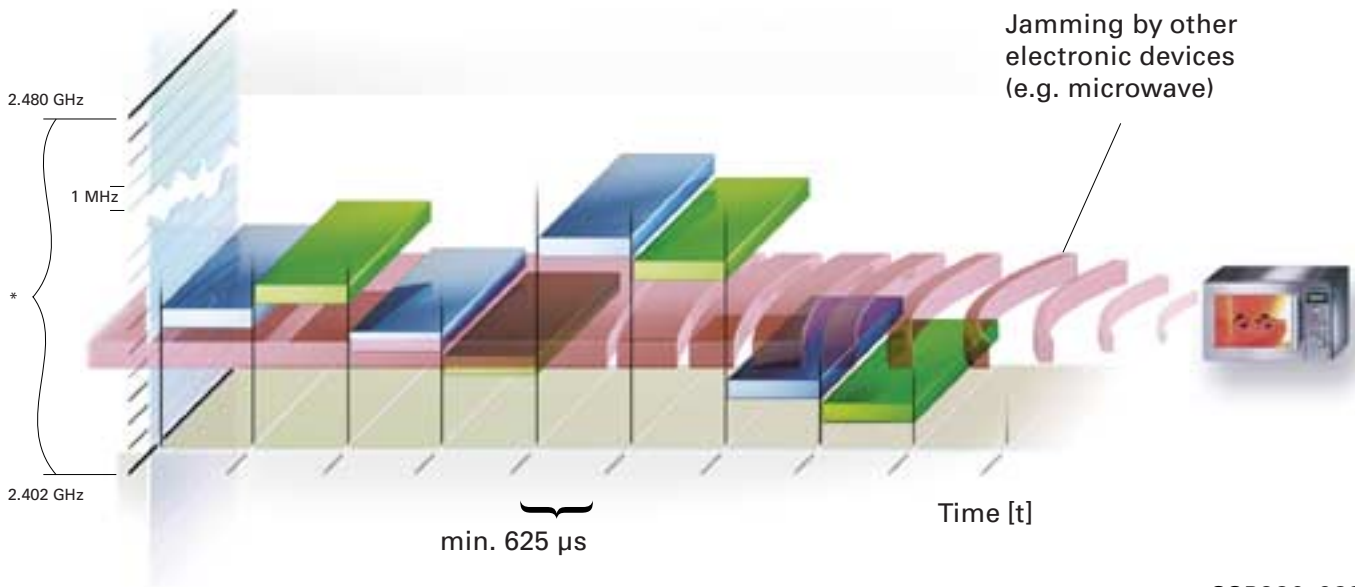

SSP286_083

* Transmission range: 79 1 MHz channels

- Master message (request)
- Slave message (response)

Data transfer in the Bluetooth™ system involves the use of radio waves in a frequency range between 2.40 and 2.48 GHz.

This frequency range is also used for other applications.

Examples:

- Garage door openers
- Microwave ovens
- Medical appliances

Interference immunity

Through the use of measures designed to enhance interference immunity, Bluetooth™ technology reduces the interference caused by such equipment.

The control module

- Divides the data into short and flexible data packets with a duration of approx. 625 μs.
- Uses a 16-bit checksum to check that the data packets are complete.
- Automatically re-transmits data packets subject to interference.
- Makes use of stable language encoding in which the language is converted into digital signals.

Protected by copyright. All rights reserved. Audi AG. Audi AG does not guarantee or accept any liability with respect to the correctness of information in this document. Copyright by AUDI AG.

The radio module

changes the transmission and reception frequency 1600 times per second on a random basis after each data packet. This is referred to as frequency hopping.

Bluetooth™

Data security

During the development of Bluetooth™ technology, the manufacturers placed great emphasis on the protection of the data transmitted against manipulation and unauthorised monitoring.

A 128-bit code is used to encode the data.

The authenticity of the receiver is also checked with a 128-bit code. In this process the units use a secret password for mutual identification of the individual users.

A new code is generated for each link.

As the range is restricted to 10 metres, manipulation can only take place within this area, thus additionally enhancing data security.

The above-mentioned interference immunity measures also increase the level of protection against manipulation of the data stream.

Data security can be further increased by equipment manufacturers through the additional use of complex encoding methods, different security levels and network protocols.

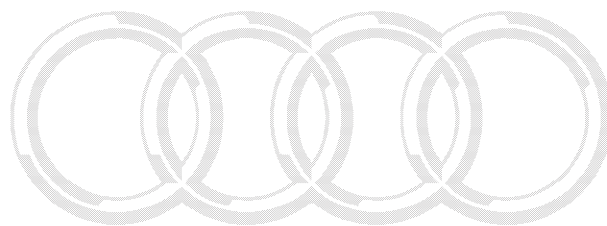

Audi

Protected by copyright. Copying for private or commercial purposes, in part or in whole, is not permitted unless authorised by AUDI AG. AUDI AG does not guarantee or accept any liability with respect to the correctness of information in this document. Copyright by AUDI AG.



Diagnosis

The diagnostic procedure for the Bluetooth™ link is implemented with the aid of the master control unit address word.

Example:

In the Audi A8 '03, the telephone/telematics control unit J526 is the Bluetooth™ master.

Address word Telephone	77
Emergency call module	75

The Bluetooth™ link between the telephone handset and the telephone/telematics control unit J526 is monitored by checking the Bluetooth™ aerial.

An entry is made in the fault memory if there is a break in the link with the aerial.

Bluetooth™ aerial

- No signal/no communication

The measured value blocks provide a display of

- The number
- The unit number
- The field strength of the radio link

of the portable units communicating with the master control unit.

The Bluetooth™ function can be activated or deactivated in the Bluetooth™ master adaption process.

Examples:

- Transportation of vehicle by air
- Use of vehicle in countries where Bluetooth™ frequencies are not authorised

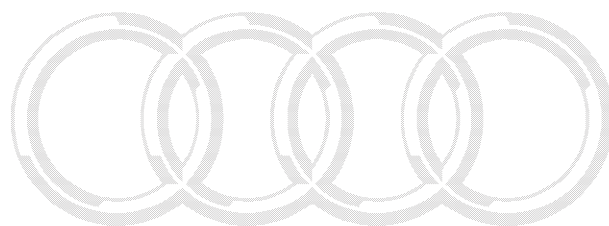

Audi

Protected by copyright. Copying for private or commercial purposes, in part or in whole, is not permitted unless authorised by AUDI AG. AUDI AG does not guarantee or accept any liability with respect to the correctness of information in this document. Copyright by AUDI AG.



Diagnosis bus

Introduction

The diagnosis CAN is used to exchange data between the diagnosis unit and the control units fitted in the vehicle, thus obviating the need for the K or L-wires previously required (exception: emission-specific control units). Diagnosis is implemented using the vehicle diagnostic, testing and information system VAS 5051 or the vehicle diagnostic and service information system VAS 5052.

The control-unit diagnostic data are transmitted by way of the respective data bus system to the diagnosis interface for data bus J533 (gateway).

Thanks to the rapid data transfer via the CAN and the high performance of the gateway, the diagnosis unit is able to display a list of the components fitted and their fault status immediately after connection to the vehicle.

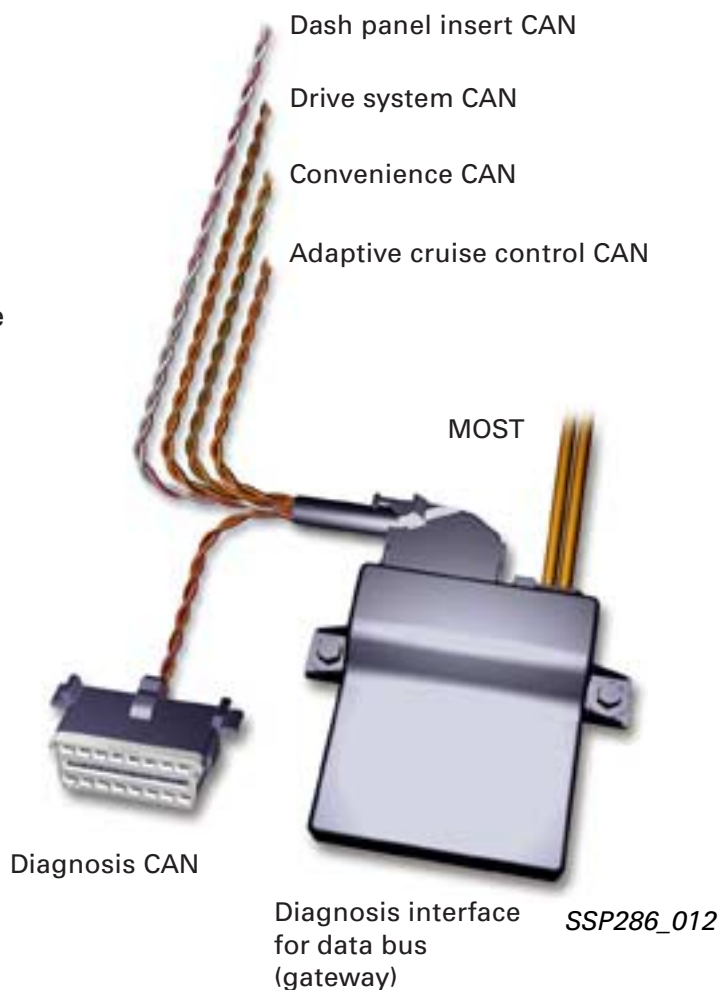

The diagnosis CAN uses a non-screened twisted pair of wires with a cross-section of 0.35 mm^2 each.

The CAN low wire is orange/brown and the CAN high wire orange/violet.

Data are transferred at a rate of 500 kbit/s in full duplex mode. This means that data can be transmitted in both directions at once.

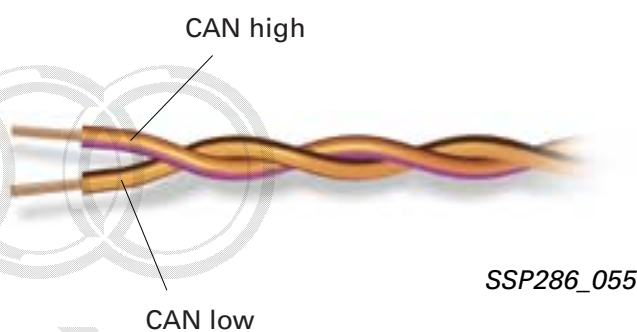

Protected by copyright. Copying for private or commercial purposes, in part or in whole, is not permitted unless authorised by AUDI AG. AUDI AG does not guarantee or accept any liability with respect to the correctness of information in this document. Copyright by AUDI AG.



Diagnosis can be implemented under the following conditions:

No.	Diagnosis	Condition		Remarks
1	Start	With ignition on	Yes	Wake-up of control unit via diagnosis CAN is not possible
		With ignition off	Yes, but not in sleep mode	
2	Implementation	With ignition on	Yes	
		With ignition off	Yes, but no write functions (e.g. control unit encoding)	
3	End	Termination by switching off ignition	No	



Implementation of diagnosis on the vehicle requires use of the new diagnosis wires VAS 5051/5A (3 m) or VAS 5051/6A (5 m). These new diagnosis wires can also be used with the familiar diagnosis systems employing K or L-wire.



SSP286_056

The current basic software version is also required for diagnosis.

VAS 5051: Basic software 3.0 for diagnosis via CAN

VAS 5052: Basic software

Basic software modification is accompanied by the addition of new functions and alterations to the tester user interface.



SSP286_051

Diagnosis bus

Extension of forms of address

In addition to the direct addressing of individual control units, provision is now also made for group addressing, i.e. the fault memory content of several control units can be interrogated more or less simultaneously.

This considerably speeds up readout of the fault memory content.

Selective control element test

The selective control element test permits direct activation of actuators without having to adhere to a specified sequence.

In addition, it is possible to simultaneously display control-unit measured value blocks for checking switches and sensors.

These new features offer additional options as part of assisted fault-finding.



Assisted fault-finding	Audi	V00.03 25/04/2002
Functional test	Audi A8 2003>	
	2003 (3)	
Selective control element test, -J520 CU 2	Saloon	
Vehicle electrical system	BFL 3.7l Motronic / 206 kW	

Test sequence

The control element routine permits selective actuation of individual control elements of vehicle voltage control unit 2 if fitted/encoded.

Ready

1. Functional description

Measurement Vehicle self-diagnosis Jump Print Help

SSP286_089

Assisted fault-finding	Audi	V00.03 25/04/2002
Functional test	Audi A8 2003>	
	2003 (3)	
Selective control element test, -J520 CU 2	Saloon	
Vehicle electrical system	BFL 3.7l Motronic / 206 kW	

Control element interrogation 1 to 6

Which control element is to be actuated?
(control element selection 1 to 6)

1. Retract MMI display rotation mechanism
2. Extend MMI display rotation mechanism
3. KI58D 90% interior light dimming
4. Servotronic/full power assistance
5. Servotronic/no power assistance
6. Extend right headlight washer system nozzle

- 1 -
- 2 -
- 3 -
- 4 -
- 5 -
- 6 -
- Return -

1. Functional description

Measurement Vehicle self-diagnosis Jump Print Help

Protected by copyright. Copying for private or commercial purposes, in part or in whole, is not permitted unless authorised by AUDI AG. AUDI AG does not guarantee or accept any liability with respect to the correctness of information in this document. Copyright by AUDI AG.

SSP286_090



Example:

The illustration shows the selective control element test for vehicle voltage control unit 2 J520 in the Audi A8 '03 for checking the display mechanism.

Assisted fault-finding	Audi	V00.03 25/04/2002
Functional test	Audi A8 2003>	
Selective control element test, -J520 CU 2	2003 (3)	
Vehicle electrical system	Saloon	
	BFL 3.7l Motronic / 206 kW	

With measured values/messages

Active control element: Extend MMI display rotation mechanism

Measured values/messages:

MMI limit switch open: Not actuated
 MMI limit switch closed: Actuated
 MMI motor : Inactive

Continue with ►

1. Functional description

◀ Measurement Jump Print Help ▶

SSP286_091

Pin assignment at diagnostic connector

Pin	Wire
1	Terminal 15
4	Earth
5	Earth
6	Diagnosis CAN (high)
7	K-wire
14	Diagnosis CAN (low)
15	L-wire
16	Terminal 30



Copyright. Copying for private or commercial purposes, in part or in whole, is not permitted unless authorised by AUDI AG. AUDI AG does not guarantee or accept any liability with respect to the correctness of information in this document. Copyright by AUDI AG.

SSP286_052

Pins not listed are not used at present.



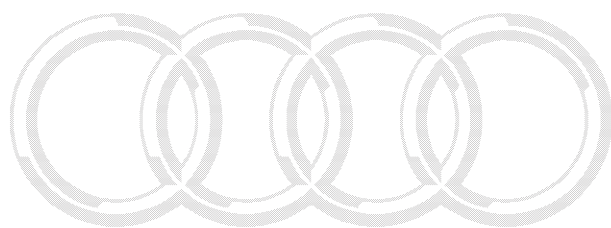

Audi

Protected by copyright. Copying for private or commercial purposes, in part or in whole, is not permitted unless authorised by AUDI AG. AUDI AG does not guarantee or accept any liability with respect to the correctness of information in this document. Copyright by AUDI AG.



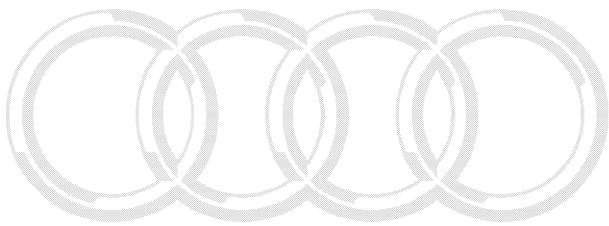

Audi

Protected by copyright. Copying for private or commercial purposes, in part or in whole, is not permitted unless authorised by AUDI AG. AUDI AG does not guarantee or accept any liability with respect to the correctness of information in this document. Copyright by AUDI AG.





Audi

Protected by copyright. Copying for private or commercial purposes, in part or in whole, is not permitted unless authorised by AUDI AG. AUDI AG does not guarantee or accept any liability with respect to the correctness of information in this document. Copyright by AUDI AG.

erWin 

All rights reserved.
Subject to technical modification.
Copyright* 2002 AUDI AG, Ingolstadt
Department I/VK-35
D-85045 Ingolstadt
Fax 0841/89-36367
000.2811.06.20
Technical status as at 05/02
Printed in Germany