



Protected by copyright. Copying for private or commercial purposes, in part or in whole, is not permitted unless authorised by AUDI AG. AUDI AG does not guarantee or accept any liability with respect to the correctness of information in this document. Copyright by AUDI AG.















AUDI A8 '03 - Infotainment

Self Study Programme 293

This Self Study Programme contains information on the infotainment system and the associated distributed functions in the Audi A8 '03.

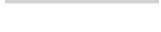
An understanding of the interaction of the components and distributed functions forms the necessary basis for successful fault-finding.

Wiring

	Convenience CAN
	Drive system CAN
	Adaptive cruise control CAN
	Dash panel insert CAN
	MOST bus
	LIN bus
	Diagnosis CAN
	Bidirectional wire
	Reception wire
	Transmission wire
	Discrete wire
	Wireless transmission – transmission signal
	Wireless transmission – reception signal
	Follow-up function
	Prerequisite

This introduction contains explanatory notes to clarify the meanings of certain terms, designations and symbols used in this Self Study Programme.

More detailed information can be found in the following Self Study Programmes:

- SSP 282 – Audi A8 '03 Technical Features
- SSP 286 – New Data Bus Systems – LIN, MOST, Bluetooth™
- SSP 287 – Audi A8 '03 Electrical Components
- SSP 288 – Audi A8 '03 Distributed Functions
- SSP 289 – adaptive cruise control in the Audi A8 '03

Components and symbols

①

A number is used to designate the information sequence described in the corresponding text.

The green circle symbolises the start of an information sequence.



The green arrow indicates input information.



The blue arrow indicates output information.



The layout of the individual components such as control units, switches or control elements as illustrated corresponds to the actual arrangement in the vehicle. Component designations are explained on the basis of their identifiers in the relevant text.



Components marked in red indicate the function master within a sequence of operations.



Components marked in yellow indicate the substitute master.

Definition of terms

Data bus network (topology)

The topology provides a general outline of the way in which control units fitted in the vehicle are interlinked by way of data bus systems.

It thus becomes clear which bus systems are used by the control units to exchange data.

Distributed functions

This term indicates that several control units are required to exchange information in order to implement a function.

Function master

With distributed functions, one control unit is always responsible for the entire sequence of operations. The function master control unit gathers all input information. The requests resulting from this are then transmitted in the form of a message on the data bus system and read into the control units concerned for corresponding actuation of the appropriate connected components.

Substitute master

In the event of function master failure affecting major functions, the task of the function master is assumed by a control unit provided for this purpose and designed to maintain the sequence of operations (possibly with certain restrictions).

Example: Opening up display

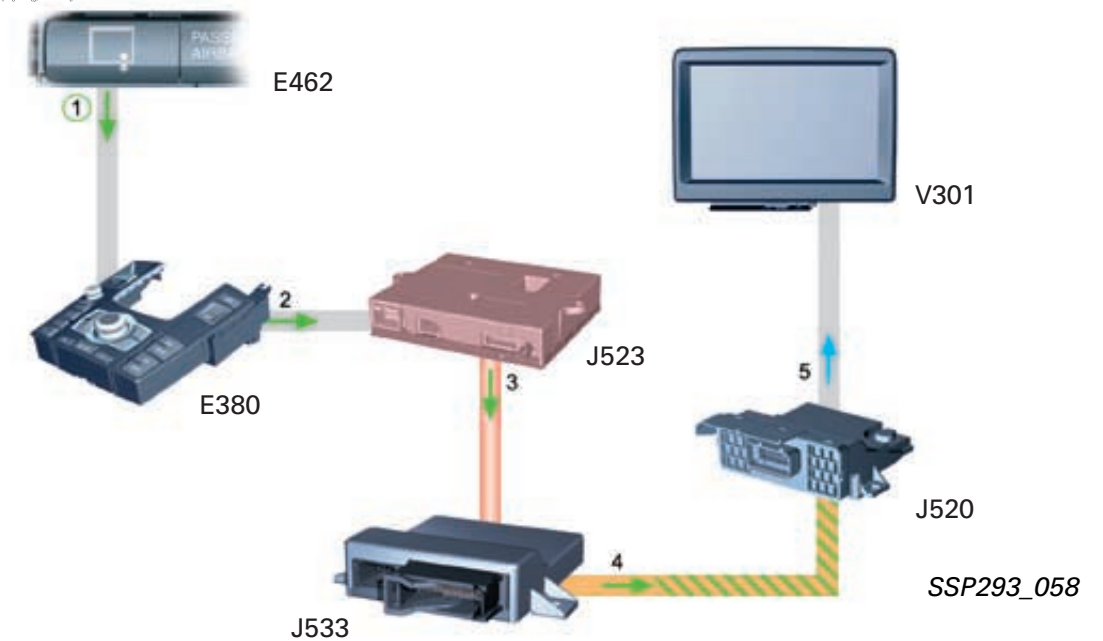

- 1 Pressing the open/close button for front display E462 transmits a signal to the multimedia operating unit E380.
- 2 The multimedia operating unit relays the signal to the front information display and operating unit control unit J523.
- 3 This signal is transmitted via the MOST bus to the data bus diagnostic interface J533.

- 4 The data bus diagnostic interface transmits the signal via the convenience CAN to the onboard power supply control unit 2 J520.
- 5 The open/close display motor V301 receives the "Open display" signal via a discrete wire. The display is opened up.

	Page
Introduction	4
Infotainment	
System layout of CAR functions	6
Infotainment system layout	8
Multimedia interface (MMI)	10
Front information display and operating unit control unit J523	17
Front information and display and operating unit control unit J685	20
Multimedia operating unit E380	27
Multi-function steering wheel and display in dash panel insert	32
Sound System	
Introduction	37
Digital Bose® Surround sound system	40
Radio Module	
Radio module R	48
Dialog system	55
Navigation	59
Telephone/Telematics	63

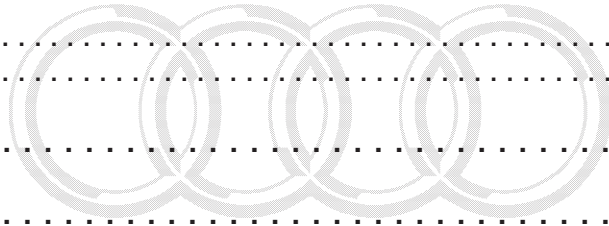
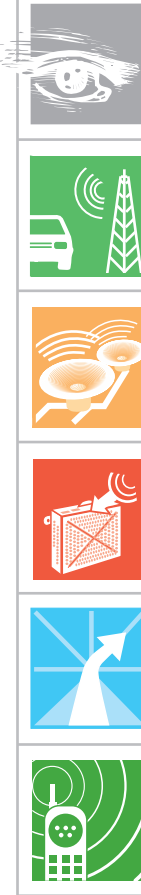

Audi

Protected by copyright. Copying for private or commercial purposes, in part or in whole, is not permitted unless authorised by AUDI AG. AUDI AG does not guarantee or accept any liability with respect to the correctness of information in this document. Copyright by AUDI AG.



The Self Study Programme contains information on design features and functions.

The Self Study Programme is not intended as a Workshop Manual. Values given are only intended to help explain the subject matter and relate to the software version applicable at the time of SSP compilation.

Use should always be made of the latest technical publications when performing maintenance and repair work.

New



Attention Note



Introduction



Summary of media and functions in the Audi A8 '03

Both in the modern business world and in the private domain, mobile **information** and **entertainment** are becoming ever more important.

In other words, vehicle occupants are becoming increasingly interested in enjoying the benefits of modern media.

With this in mind, the Audi A8 '03 is fitted with an infotainment system.

The infotainment system offers a wide range of modern media (see Fig.).





Utilisation of the media can only be achieved by the installation of a distributed system.

An understanding of the way in which the control units are interlinked forms the basis for successful fault-finding.

This means that a function, such as listening to a radio station, demands the interaction of several control units.

Example:

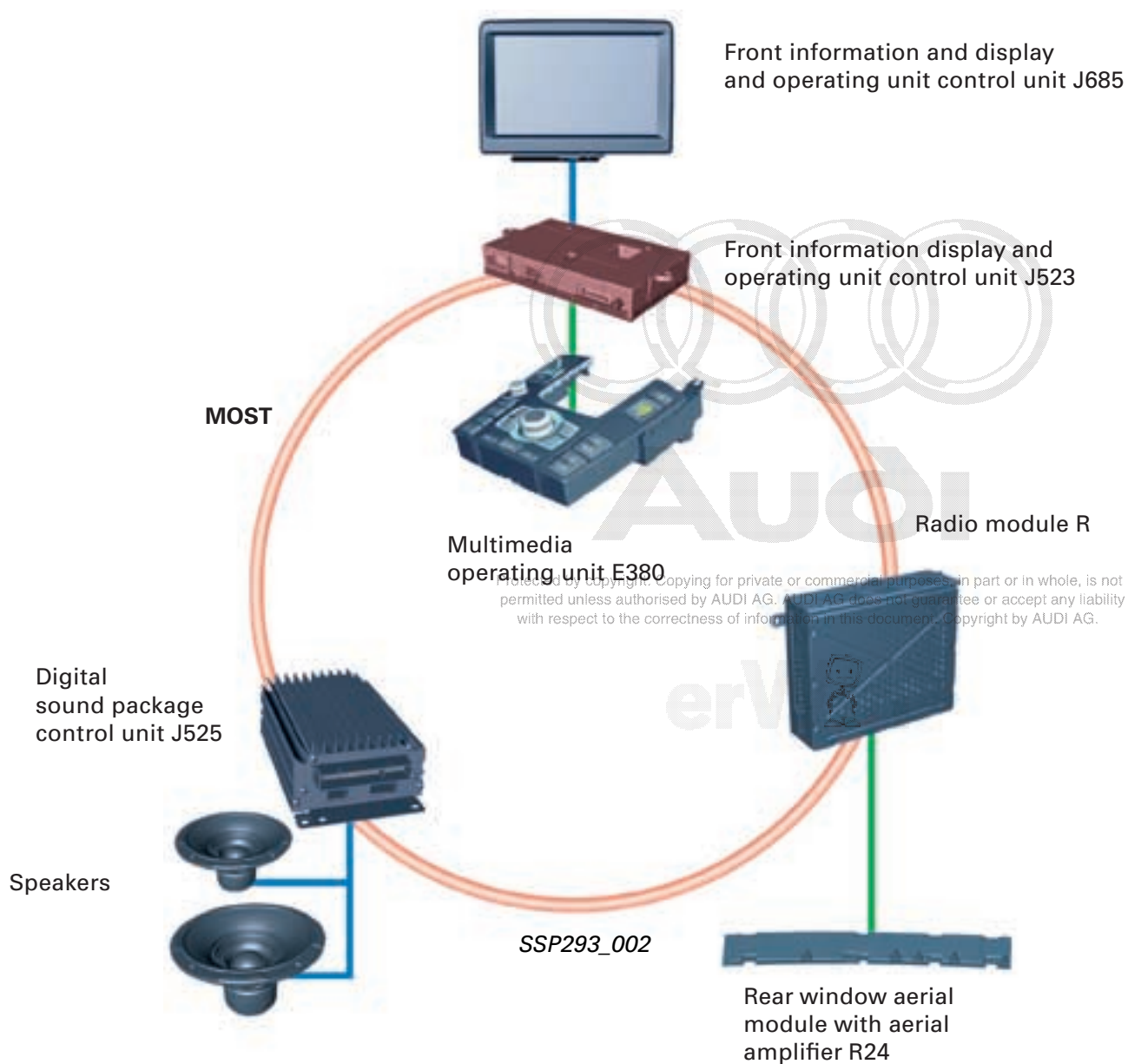

System layout

CAR functions

The multimedia interface (MMI) enables the driver to make settings for various vehicle systems.

The illustration shows the control units inter-linked for implementation of the CAR functions.

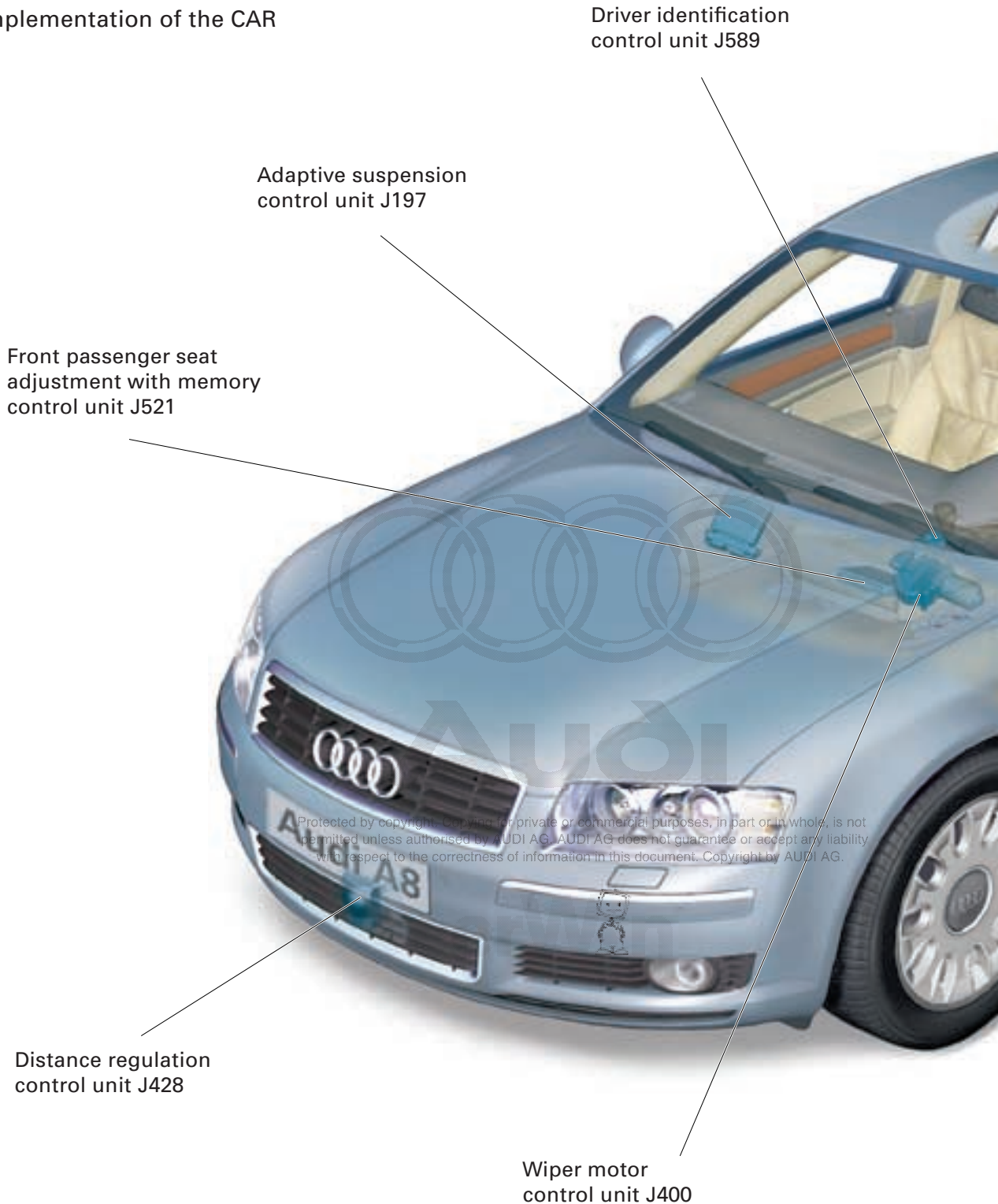



Sunroof electronics control unit J528

Convenience system central control unit J393

Parking aid control unit J446

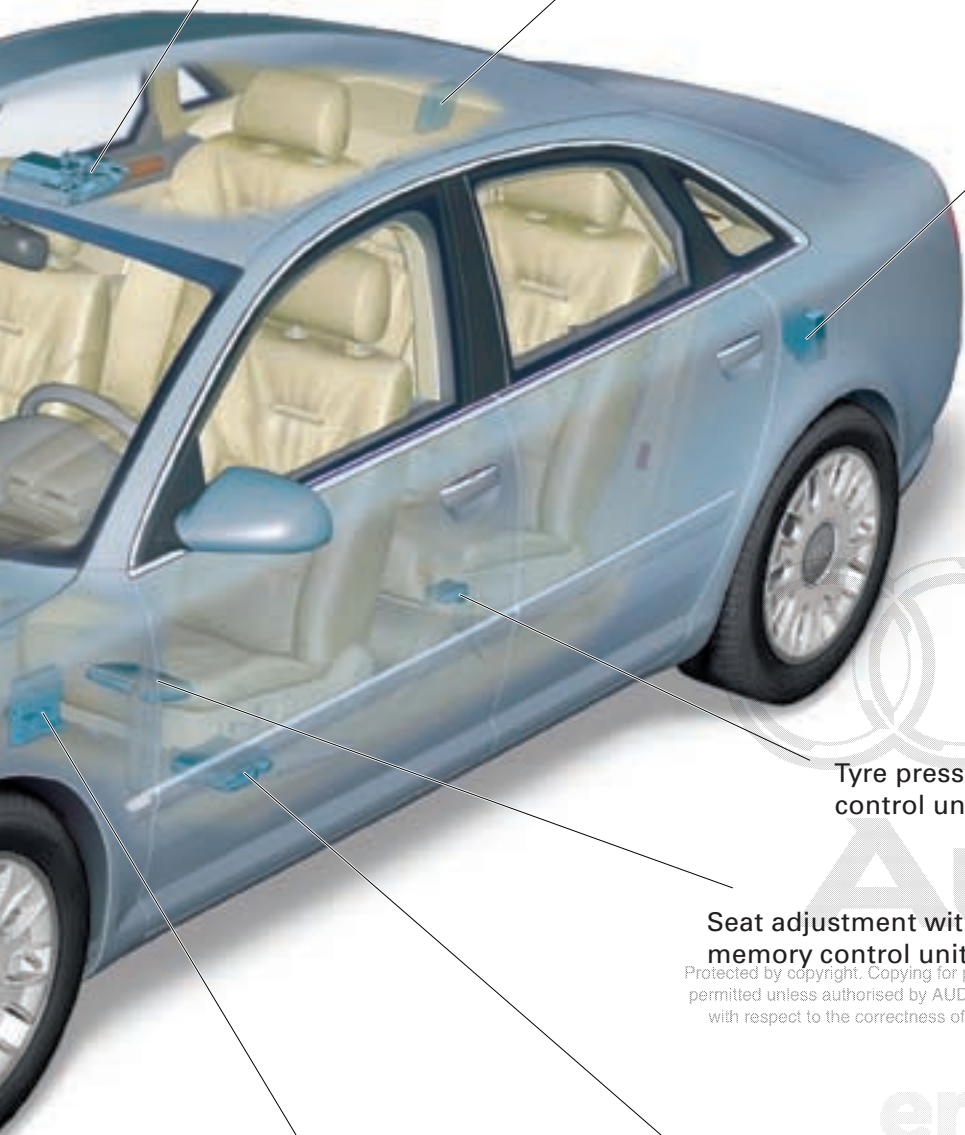

Tyre pressure monitor control unit J502

Seat adjustment with memory control unit J136

Protected by copyright. Copying for private or commercial purposes, in part or in whole, is not permitted unless authorised by AUDI AG. AUDI AG does not guarantee or accept any liability with respect to the correctness of information in this document. Copyright by AUDI AG.



Entry and start authorisation control unit J518

Onboard power supply control unit J519

Infotainment

System layout

Infotainment



Front roof module:
- Microphone unit R164
- Telematics operating unit E264

Data bus diagnostic interface J533

Front information display and operating unit control unit J523

Centre speaker

Front information and display and operating unit control unit J685

Dash panel speaker

Control unit with display in dash panel insert J285

Operating unit in steering wheel E221

Bass speaker in front door

Telephone/telematics control unit J526

Multimedia operating unit E380

Treble speaker in rear door

Bass speaker in rear door

Telephone handset R37 and telephone bracket R126

Protected by copyright. Copying for private or commercial purposes, in part or in whole, is not permitted unless authorized by AUDI AG. AUDI AG does not warrant or accept any liability with respect to the correctness of information in this document. Copyright by AUDI AG.

erWin





CD single drive R92

Aerial amplifier R24

Telephone aerial R65

CD changer R41

Navigation aerial R50

Additional loudspeaker for telematics R91

Subwoofer R148

Surround speakers in rear shelf

Additional aerial for telematics R90

Navigation system control unit J401

Radio module R and language input control unit J507

 Digital sound package control unit J525

TV tuner R78

Protected by copyright. Copying for private or commercial purposes, in part or in whole, is not permitted unless authorised by AUDI AG. AUDI AG does not guarantee or accept any liability with respect to the correctness of information in this document. Copyright by AUDI AG.

SSP293_004

Multimedia interface (MMI)

The multimedia interface enables users of the infotainment system in the Audi A8 '03 to implement a wide range of functions and settings with the aid of a central control element.

The selection menus and settings can be viewed on an additional display in the dash panel.

Users merely have to be familiar with four different control elements to be able to implement menu-driven activation of the required function.

MMI control elements

1 Main function buttons

Pressing the main function buttons calls up the main menu for the corresponding function group on the display. This permits rapid access to the desired function irrespective of the sub-menu currently being displayed.

The SETUP button is an exception to this. The content of the menu which appears after pressing the SETUP button depends on the function group previously selected.

The air conditioning system is operated by way of the Climatronic control unit J255. The setting and selection menus are however displayed in the MMI.

Entertainment
RADIO
CD/TV/DVD

Communication
Internet
Telephone

Information
Navigation
INFO/telematics

Control
CAR
SETUP



SSP293_045



The internet (NET) + telematics functions will not be available until a later date.

2 Softkeys

The functions of the softkeys differ depending on which menu is active.

The softkey functions appear in the corresponding corners of the display.

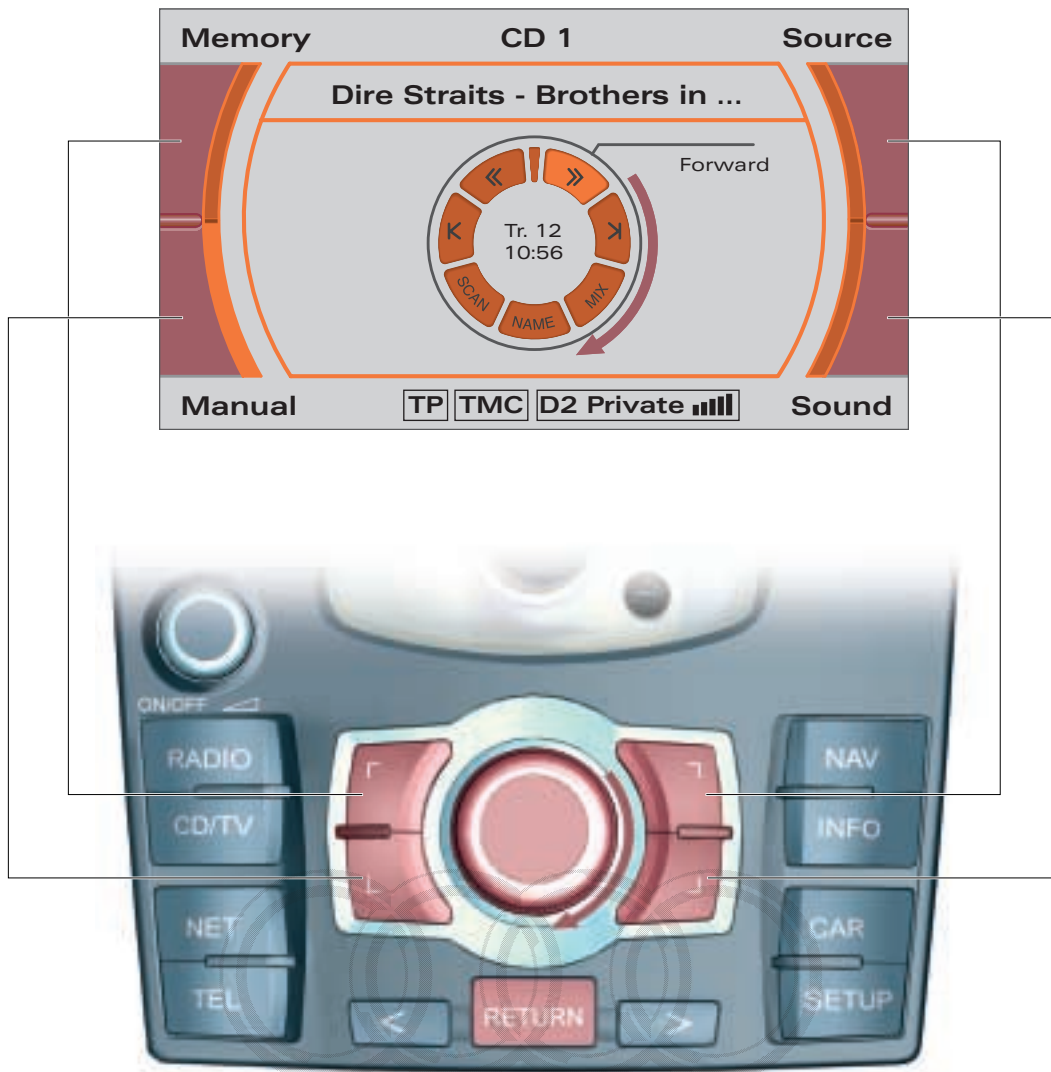

SSP293_043

3 Central control knob

4 RETURN button

Turning the control knob effects selection of a menu item or setting. Pressing the RETURN button causes the higher-ranking menu to be displayed.

Pressing the control knob confirms the selection or setting.

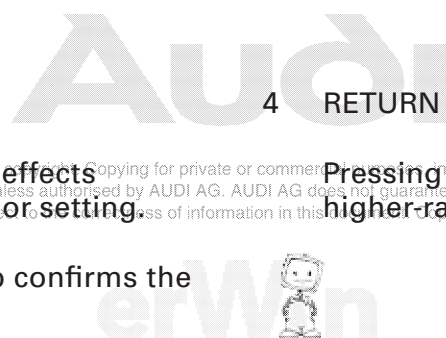

Infotainment

List of functions

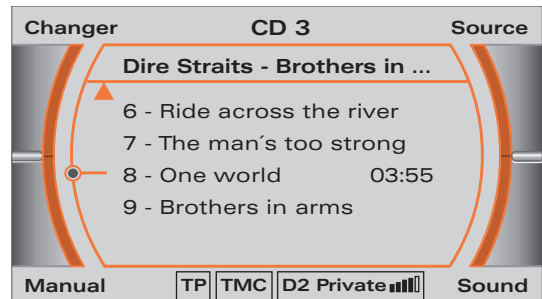
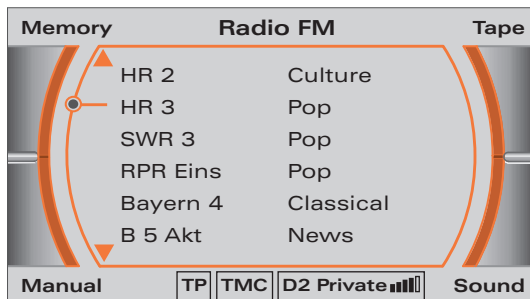

- RADIO central menu
 - Dynamic station list
- Memory
 - Memory list
- Tape
 - FM (VHF)
 - MW (medium wave)
 - LW (long wave)
 - DAB* (digital radio)
- Sound
 - <See Setup - softkey sound>
- Manual
 - Manual forward
 - Forward search
 - Store station
 - Play station
 - Search back
 - Manual back
- Radio setup
 - Traffic news
 - Regional setting
 - Station reception
 - Station display
 - Alternative frequency
 - PTY filter

Erase last stations

Protected by copyright. No reproduction, distribution or commercial purposes, in part or in whole, is not permitted unless authorised by AUDI AG. AUDI AG does not guarantee or accept any liability with respect to the correctness of information in this document. Copyright by AUDI AG.

- CD/TV central menu
 - CD track
 - TV station
- Changer
 - CD list
- Source
 - CD
 - TV
 - External AV source
- Sound
 - <See Setup - softkey sound>
- Manual
 - Forward
 - Back
 - Track back
 - Track forward
 - Track mix
 - Play track
 - Name CD
- CD/TV setup
 - ▷ CD
 - Repeat
 - Display CD text
 - ▷ TV
 - Brightness
 - Contrast
 - Colour
 - Picture format
 - TV standard

* Not yet available

- Hardkey
- Softkey
- ▷ Sub-menu
- Function

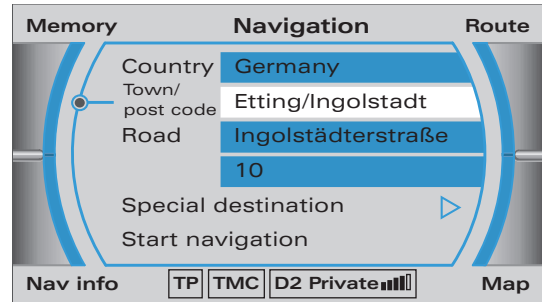
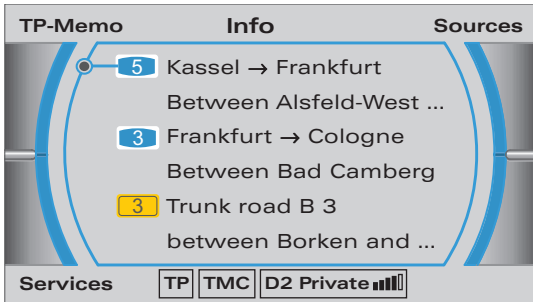

- Info central menu
 - TMC message list
- TP-Memo
 - ▷ Message call
- Sources
 - < Radio >
 - < Telephone* >
- Services
 - <Emergency call>
 - <Breakdown call>
- Info setup
 - TP-Memo Timer
 - TMC display filter

* Not yet available

- Navigation central menu
 - ▷ <Single destination mode>
 - Country
 - Town/post code
 - Road
 - Special destination
 - Start navigation
 - ▷ <Route planning mode>
 - Int. destinations 1...3
 - Destination
- Memory
 - Last destinations
 - Top special destinations
 - Destination from address book
 - Store current destination
 - Store route
 - Load route
- Route
 - Route criteria
 - Route list
 - Route with intermediate destinations
 - Route without intermediate destinations
 - Block route as of here
- Map
 - Zoom
 - Map menu
- Nav info
 - Destination
 - Location
 - GPS data

- Navigation setup
 - Map colours
 - Alignment
 - Junction zoom
 - Map type
 - Map content
 - Voice messages
 - Demo mode
 - Erase last destinations
 - Location, manual
 - Version information

Protected by copyright. Copying for private or commercial purposes, in part or in whole, is not permitted unless authorised by AUDI AG. AUDI AG does not guarantee or accept any liability with respect to the contents of information in this document. Copyright by AUDI AG.

Infotainment

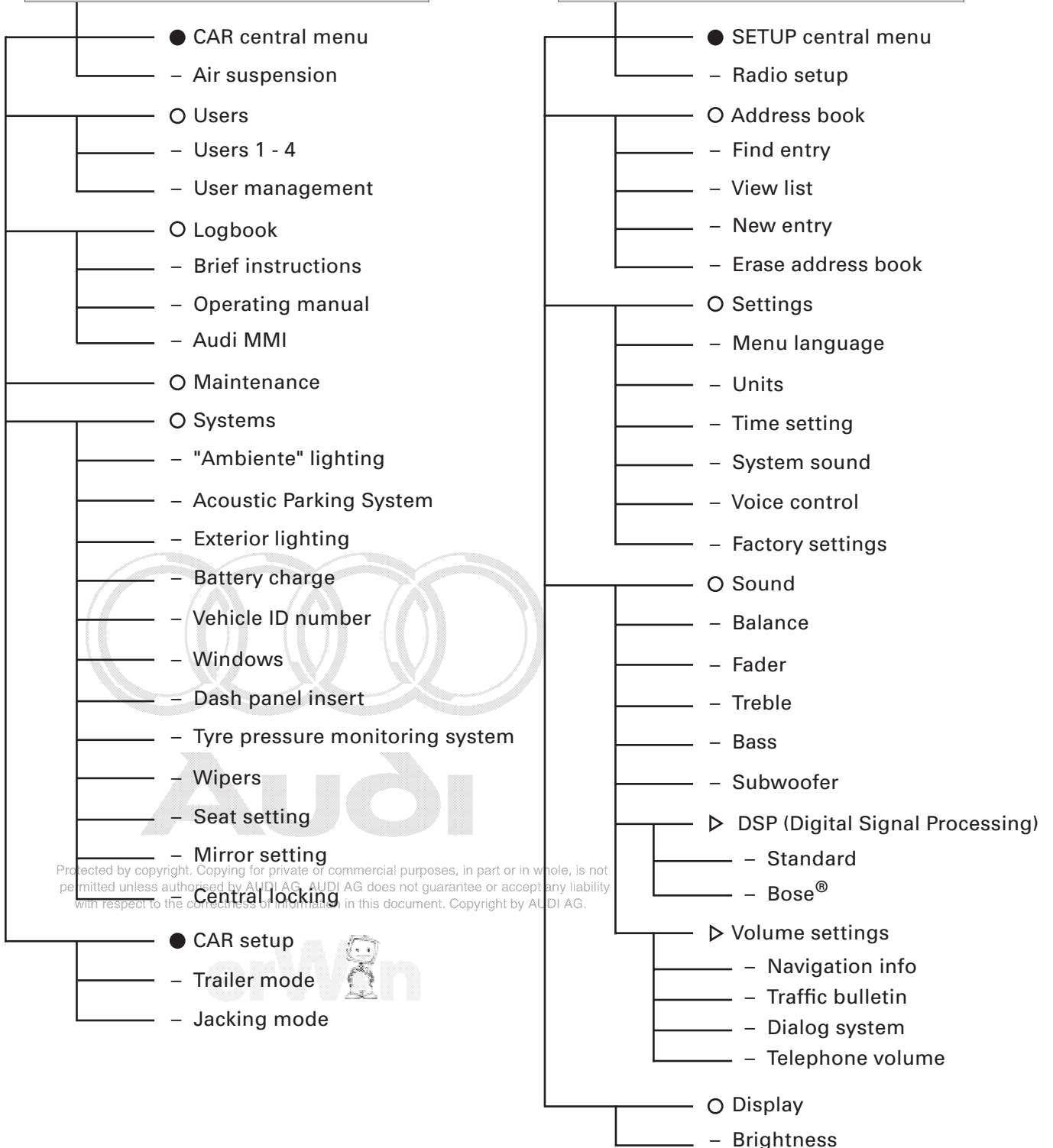
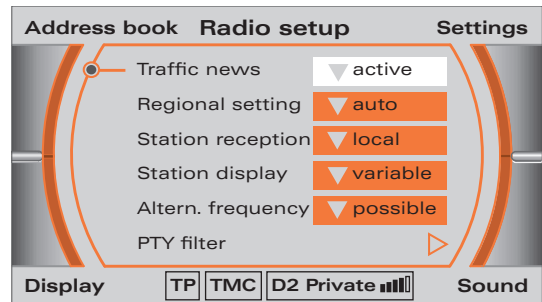
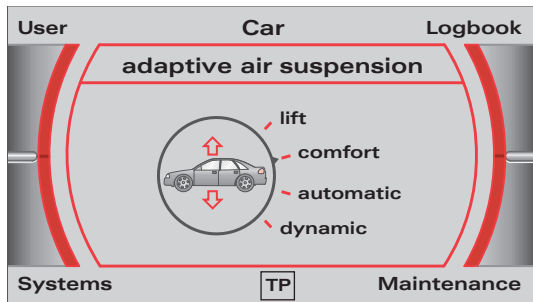

Protected by copyright. Copying for private or commercial purposes, in part or in whole, is not permitted unless authorised by AUDI AG. AUDI AG does not guarantee or accept any liability with respect to the correctness or completeness of information in this document. Copyright by AUDI AG.

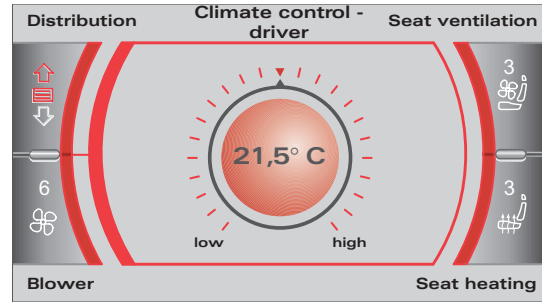
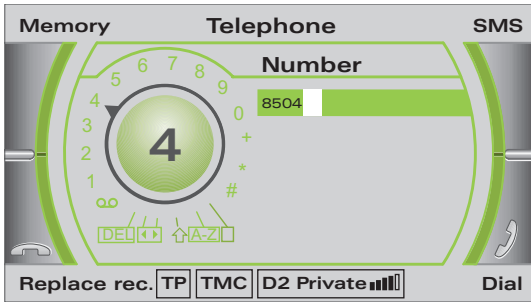

- Telephone central menu
 - Enter PIN
 - Telephone menu
- Memory
 - Address book
 - Numbers dialled
 - Calls accepted
 - Calls during absence
 - Number of SIM card
 - Store current number
- SMS
 - New SMS
 - Standard
 - SMS in
 - SMS out
 - SMS memory
 - Erase all SMS read
 - Erase all SMS
- Dial
- Replace receiver
- Telephone setup
 - Telephone settings
 - Call options
 - Security settings
 - Mailbox
 - Call re-routing
 - Network selection

- Climate control central menu
 - Driver
 - Front passenger
- Distribution
 - Driver
 - Front passenger
- Seat ventilation
 - Driver
 - Front passenger
- Seat heating
 - Driver
 - Front passenger
- Blower
 - Driver
 - Front passenger
- Climate control setup
 - Econ
 - Automatic air recirculation
 - Synchronisation
 - Centre vent
 - ▶ Rear control
 - Solar operation
 - Auxiliary heating
 - Auxiliary ventilation
 - Timer setting
 - Operating time

Protected by copyright. Copying, in whole or in part, is not permitted unless authorised by AUDI AG. AUDI AG does not guarantee or accept any liability with respect to the content of this document. Copyright by AUDI AG.



Design

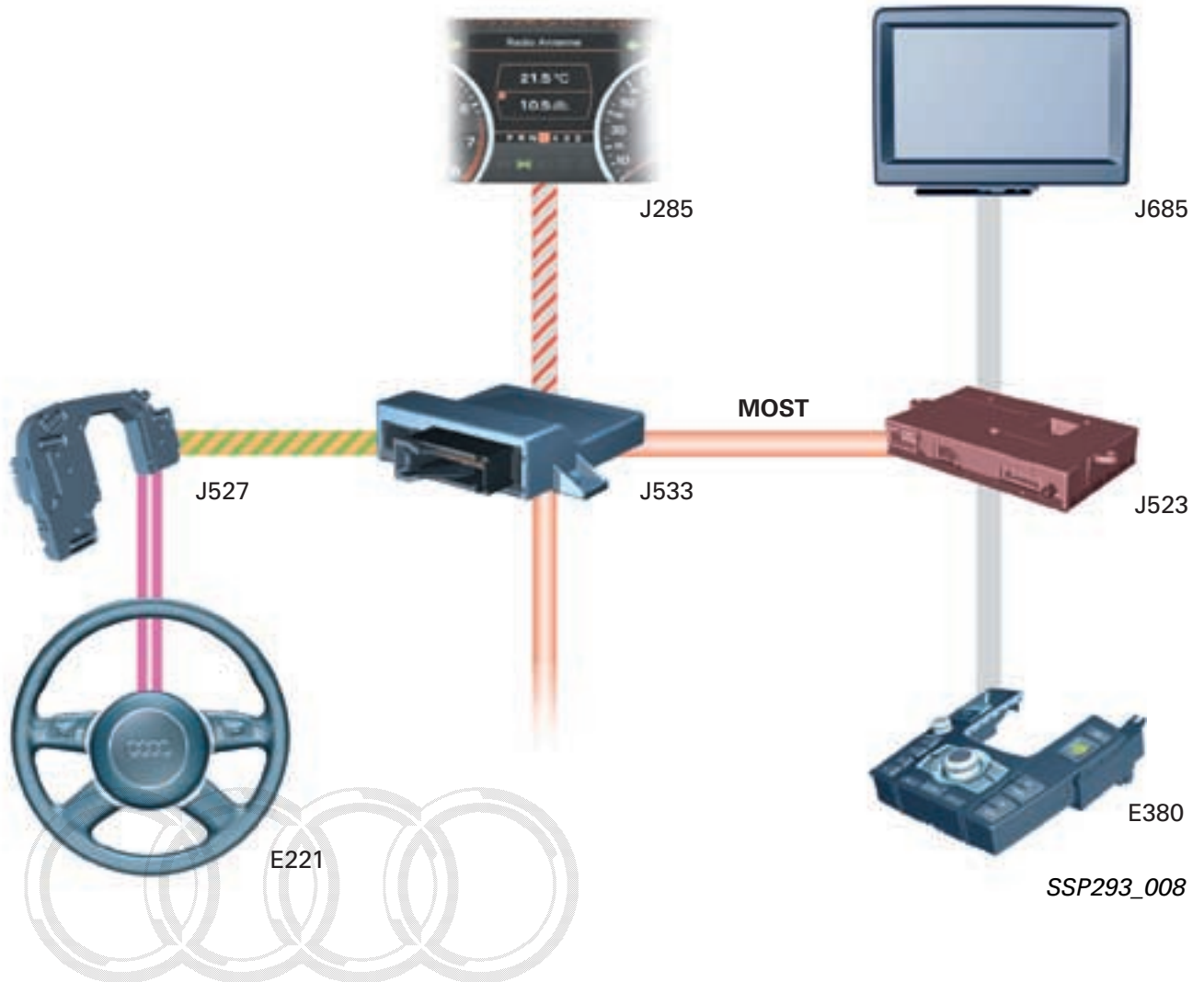

SSP293_008

The multimedia interface (MMI) consists of the following:

- Front information display and operating unit control unit J523
- Front information and display and operating unit control unit J685
- Multimedia operating unit E380
- Operating unit in steering wheel E221
- Control unit with display in dash panel insert J285

Data are transferred from the steering wheel operating unit via the steering column electronics control unit J527 and data bus diagnostic interface J533 to the corresponding control units.

Front information display and operating unit control unit J523

Control unit J523 is the infotainment system master control unit.

Functions

- Reception of user function requests with the aid of the multimedia operating unit E380 and dialog system (SDS, optional)
- Control of communication on MOST bus (it thus represents the MOST bus system manager; for information on MOST bus, refer to SSP 286 – New Data Bus Systems – LIN, MOST, Bluetooth™)
- Actuation of front information and display and operating unit control unit J685 for displaying information
- Actuation of control unit with display in dash panel insert J285 for displaying MMI information
- Diagnosis for multimedia operating unit E380 and front information and display and operating unit control unit J685



SSP293_030

Fitting location

Front information display and operating unit control unit is fitted at module carrier behind glove box.



SSP293_023



Input and output signals

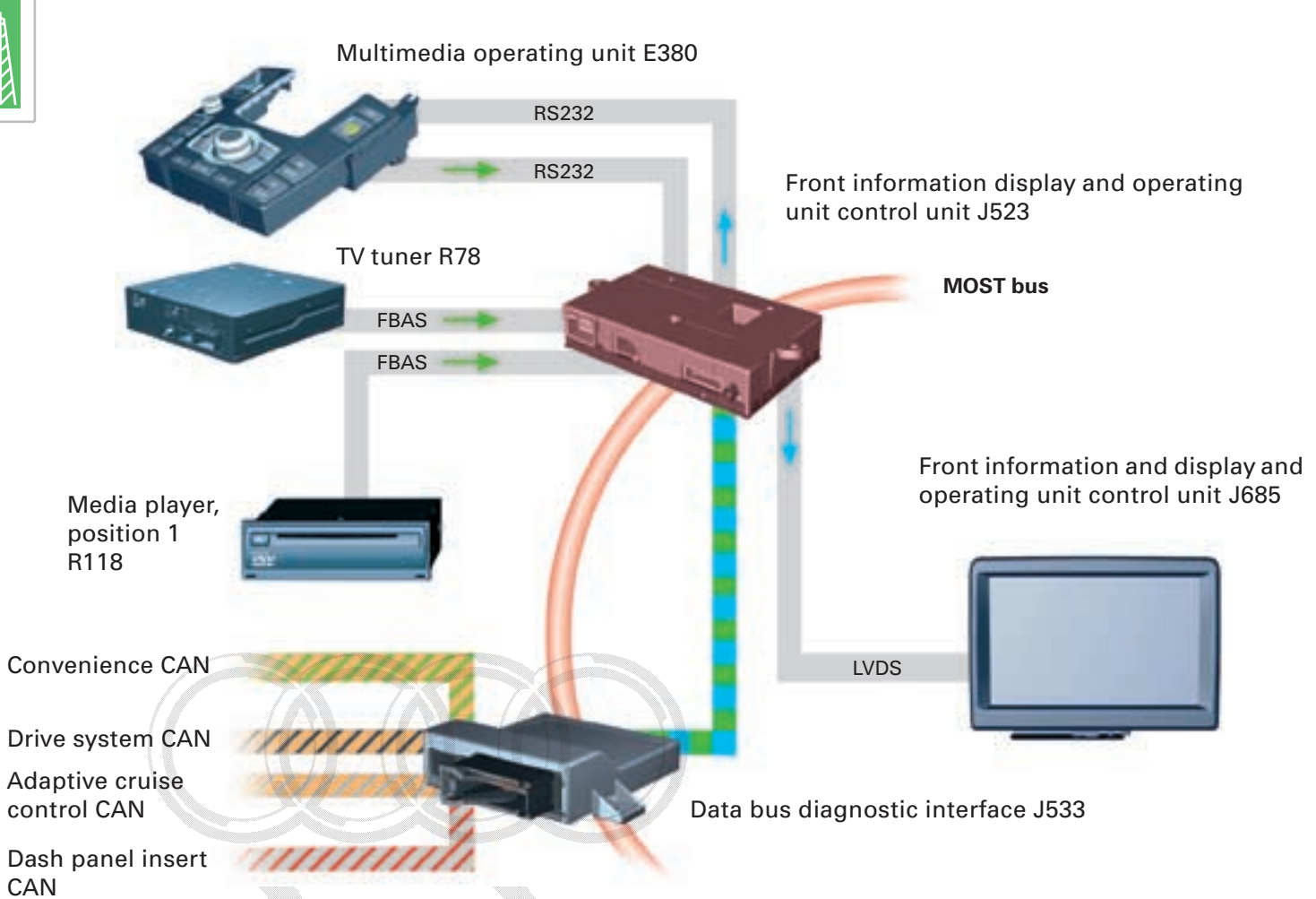

SSP293_009

Protected by copyright. Copying for private or commercial purposes, in part or in whole, is not permitted unless authorised by AUDI AG. AUDI AG does not guarantee or accept any liability with respect to the correctness of information in this document. Copyright by AUDI AG.

The front information display and operating unit control unit J523 uses a great number of input signals and controls a wide range of functions.

For the sake of clarity, the input and output signals of the front information display and operating unit control unit are explained in greater detail in the descriptions of the individual components and functions contained in this Self Study Programme.

The illustration shows the layout of the components connected to the front information display and operating unit control unit.

Diagnosis

Address word 07 - Control and display unit

The self-diagnosis monitors

- Communication with other control units via MOST bus/data bus diagnostic interface/CAN bus
- Power supply
- Temperature of Fibre Optical Transmitter (FOT)
(refer to SSP 286 - New Data Bus Systems)
- Operation of MOST bus

Corresponding fault memory entries are made in the event of malfunction.

Encoding

The encoding sets the MMI language version.

Adaption

The following settings can be made in adaption mode:

- List of control units fitted for implementation of CAR functions
- RHD/LHD
- Time span for automatic closing of info menu
- Speed shutoff threshold for TV picture, CAR menu, adaption process for one touch memory
- Reduction of optical power of FOT for test purposes

Measured value blocks

The following measured values are displayed in the measured value blocks:

- Power supply
- Status of terminals S, 15, X, 50
- MOST address (position in ring)
- MOST identifier (type of unit)
- Status of diagnosis wire



Protected by copyright. Copying for private or commercial purposes, in part or in whole, is not permitted unless authorised by AUDI AG. AUDI AG does not guarantee or accept any liability for the accuracy of the information in this document. Copyright by AUDI AG.

Infotainment



Front information and display and operating unit control unit J685

The display unit is concealed when switched off.

It is opened up on activating the MMI system with the aid of an electrically actuated mechanical unit in the centre section of the dash panel.



Milled rupture joints are provided in the housing for crash safety.

Mechanical unit

Design

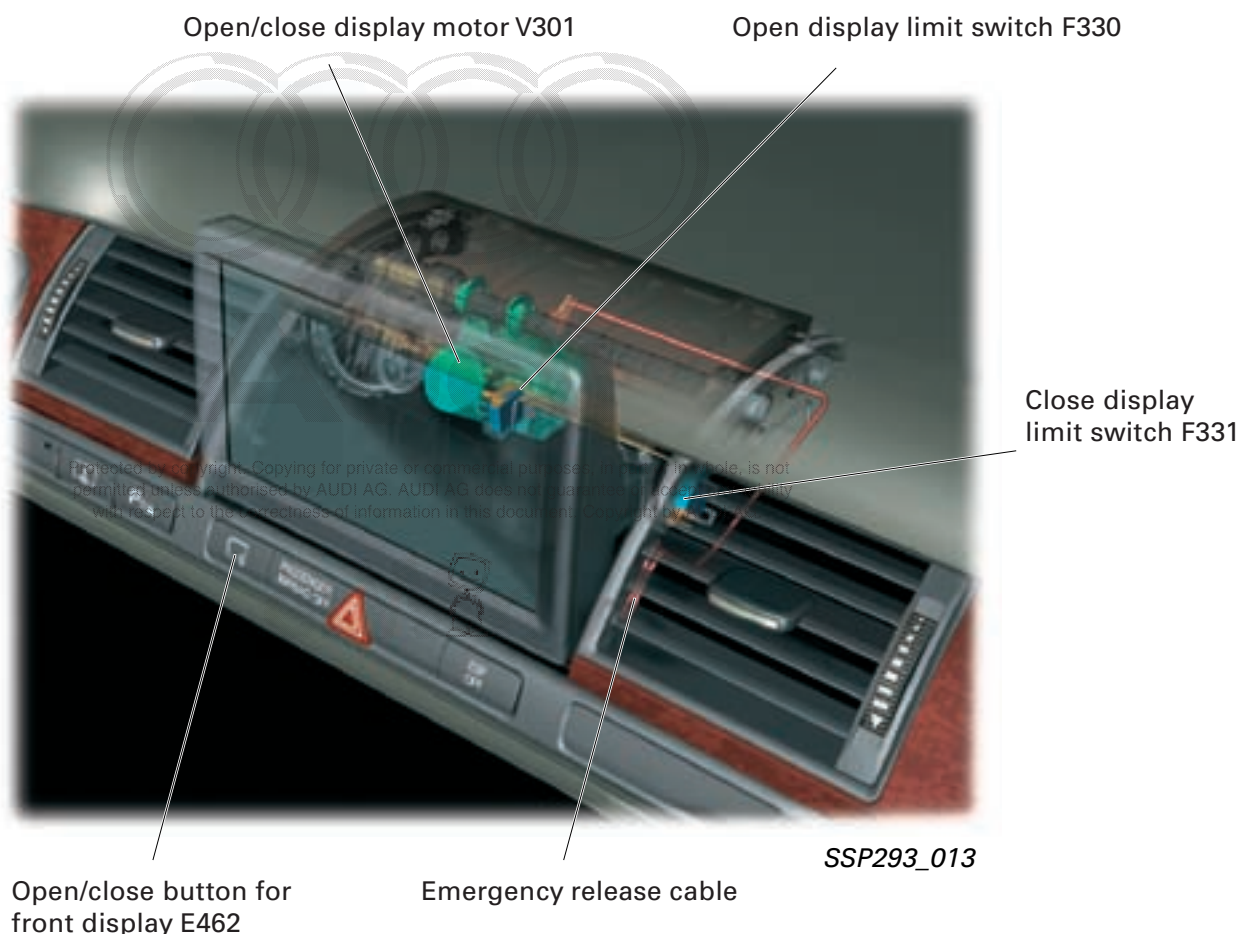

Operation

The display unit is opened up after activating the MMI or by way of the open/close button for front display E462.

When the ignition is switched on, the display unit is returned to the status prior to switching off the ignition.

Operation

The motor for opening up the display unit is actuated by the onboard power supply control unit 2 J520 with the aid of a regulated voltage. The voltage level influences the opening up and closing speed and can be set in adaption mode.

The onboard power supply control unit 2 recognises full opening up/closing of the display unit by way of the display unit open/closed limit switches.

When the display has been opened up, two spring-loaded balls engage in the display unit mount.

After reaching the end position, reduced voltage is still applied to the motor for a brief period to ensure firm positioning against the stop. This prevents rattling.



Obstruction safeguard

The obstruction safeguard takes the form of a dog clutch integrated into the motor.

Emergency release

Removing the chest vent provides access to the cable-operated emergency release. Pulling the cable disengages the dog clutch in the motor and the mechanism is free to move.

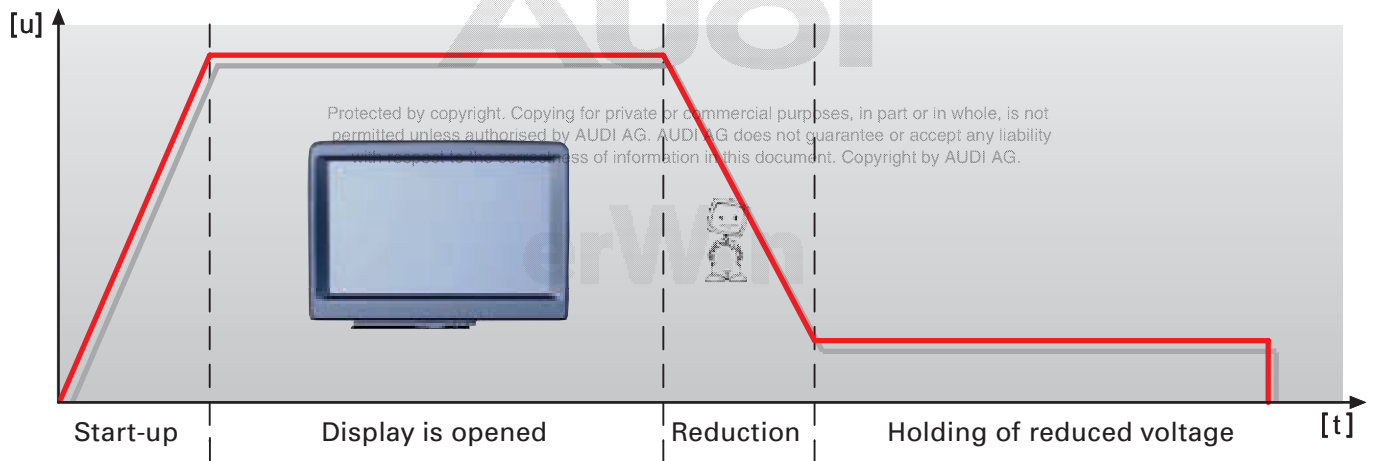

SSP293_015

Opening up and closing of display

Address word 4E - Electronic central electrics 2

The statuses of the limit switches are displayed in the measured value blocks.

The holding time and voltage level can be set in adaption mode.

Infotainment

Display

The display has dimensions of 154 x 87 mm and a resolution of 480 x 240 pixels.

Thin-film transistor (TFT) technology as used for flat screens, notebooks and notepads provides high quality image representation.

Display options:

Input and setting menus

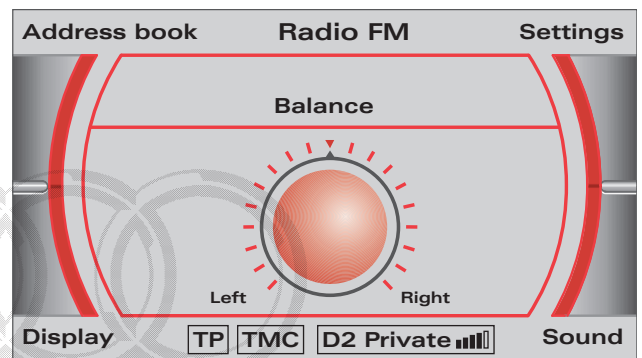

Navigation system map display

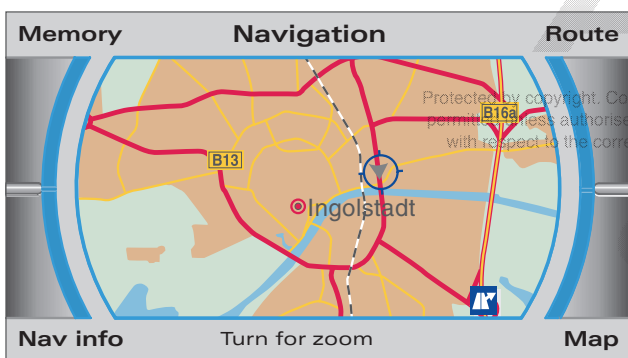

PC interfaces (internet, email)

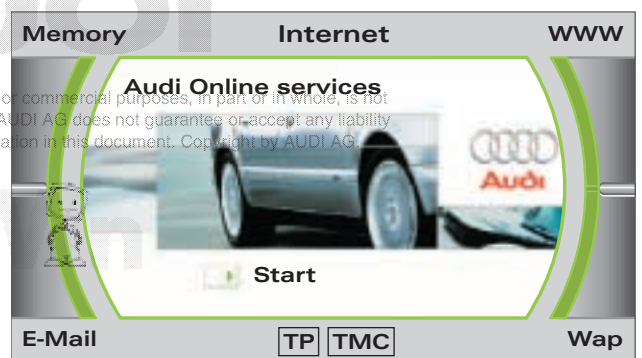

TV and video images in 16 : 9 format



Input and output signals

The front information and display and operating unit control unit J685 is directly linked by way of a 22-core wire to the front information display and operating unit control unit J523.

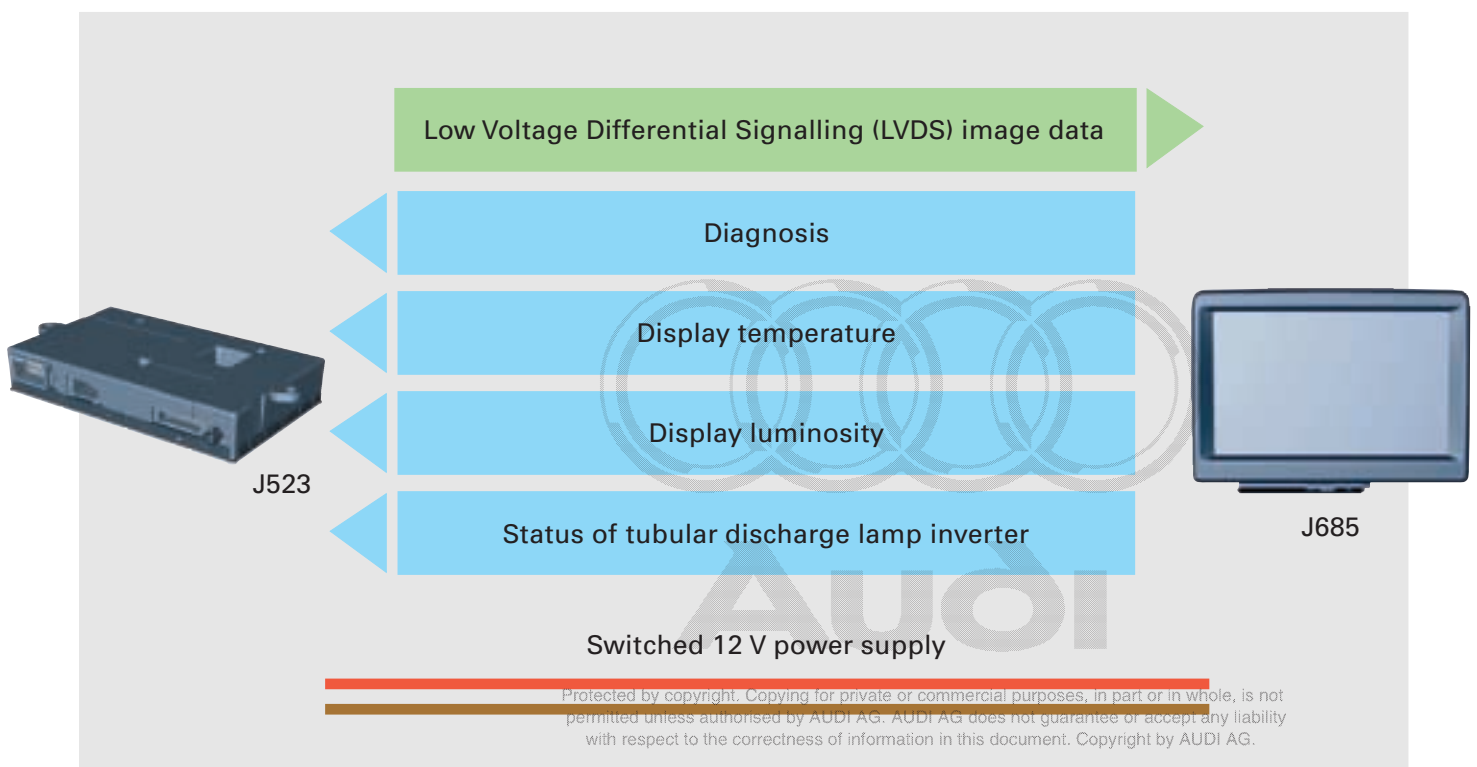

erWin

SSP293_017



The wire is not intended to be repaired. It must be replaced complete. Take care to ensure clearance from opening-up/closing mechanism when laying wire.



Low Voltage Differential Signalling (LVDS)

The LVDS signal is used in modern communication equipment such as computers for digital transmission of the image data from the processor unit to the display.

To ensure electromagnetic compatibility (EMC), the signal requires twisted wire pairs similar to CAN bus technology.

In other words, opposing voltage signals are transmitted on the two wires to prevent interference with other electronic systems.

The voltage difference between the recessive and dominant bit is only 0.5 V, hence the designation Low Voltage Differential Signalling (LVDS) for this technology.

In contrast to a CAN bus, LVDS is not used to transmit data packets. The bits are transmitted continuously.

The transmission frequency is 210 MHz. Service checking of this signal is not possible with the measuring instruments currently available.

The function of the LVDS signal is therefore monitored in the Audi A8 by the front information display and operating unit control unit J523 by way of comprehensive self-diagnosis.

Whenever the system is switched to standby mode (refer to SSP 286 – New Data Bus Systems), the front information display and operating unit control unit J523 transmits data to the front information and display and operating unit control unit J685 for checking the LVDS link.

The incoming data are checked in the display unit for completeness and plausibility by way of a computer operation.

If the display unit establishes that the LVDS signal is not OK, it uses a diagnosis wire to transmit a fault message back to the control unit.

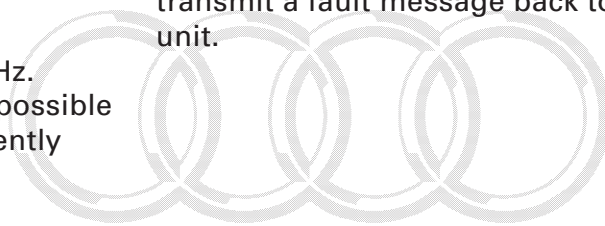

Audi

Protected by copyright. Copying for private or commercial purposes, in part or in whole, is not permitted unless authorised by AUDI AG. AUDI AG does not guarantee or accept any liability with respect to the correctness of information in this document. Copyright by AUDI AG.

Display temperature

The display is fitted with an NTC temperature sensor.

The temperature sensor permits checking of the current display temperature.

Proper operation is guaranteed over a broad temperature range.

Exceeding the display operating temperature can damage the display unit.

This can initially be seen from bright areas at the corners of the display but ultimately leads to total failure.

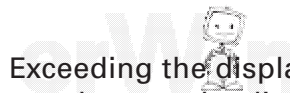

Status of tubular discharge lamp inverter

The display unit is fitted with two tubular discharge lamps to illuminate the viewing points.

Voltages of up to 1300 V are applied to the tubular discharge lamps. This high voltage has to be generated by an inverter integrated into the display unit.

In addition, the inverter recognises the failure of one or both tubular discharge lamps. The display unit relays this information by way of an additional wire to the control unit J523.

Display luminosity

In the Audi A8, the control unit with display in dash panel insert J285 sets the degree of switch and display dimming.

The dimming level is transmitted as a percentage value to the corresponding control units by way of the data bus systems.

In order to adjust the illumination of the display unit to the specified degree of dimming, the control unit J523 has to be provided with the current luminosity as feedback.

This measured value is determined by a photodiode installed in the display and transmitted on an additional wire from the display to the control unit J523.

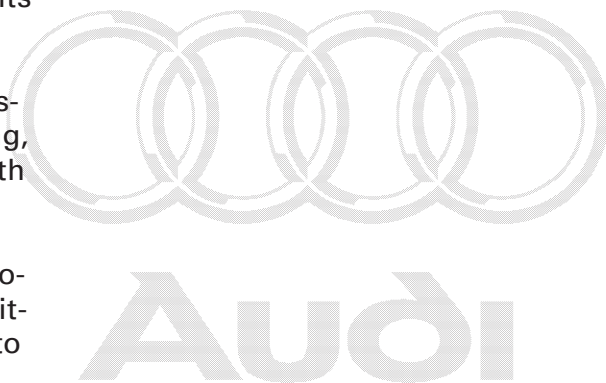

Protected by copyright. Copying for private or commercial purposes, in part or in whole, is not permitted unless authorised by AUDI AG. AUDI AG does not guarantee or accept any liability with respect to the correctness of information in this document. Copyright by AUDI AG.





Diagnosis

Address word 07 - Control and display unit

The display unit fault messages

- LVDS signal failure
- Failure of one or both tubular discharge lamps
- Maximum permissible temperature exceeded

The current temperature and luminosity of the display unit are indicated in the measured value blocks.

are stored in the fault memory.

Test pattern selection

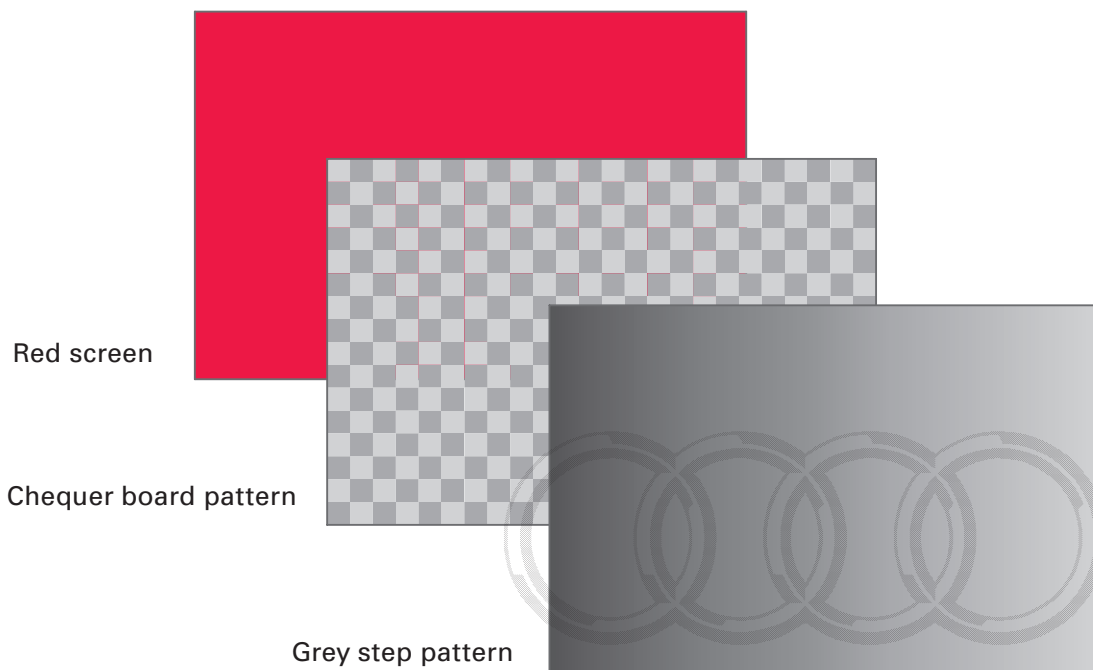

SSP293_018

The adaption mode can be used to present various test patterns in the display unit.

In addition, the brightness of the display unit can be adjusted using the adaption function.

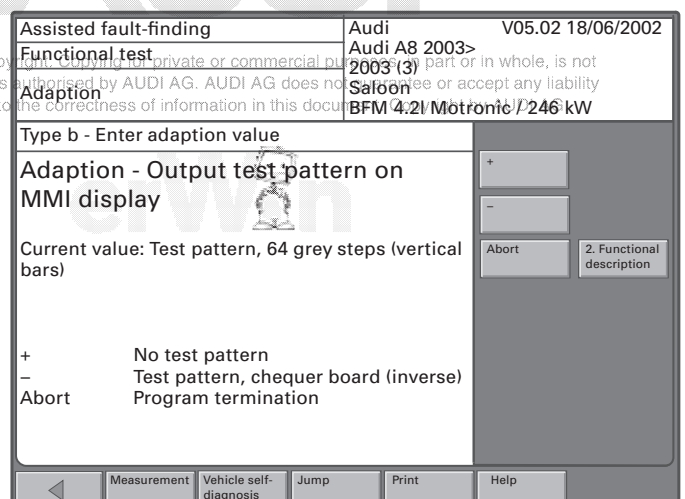

SSP293_034

Multimedia operating unit E380



SSP293_022

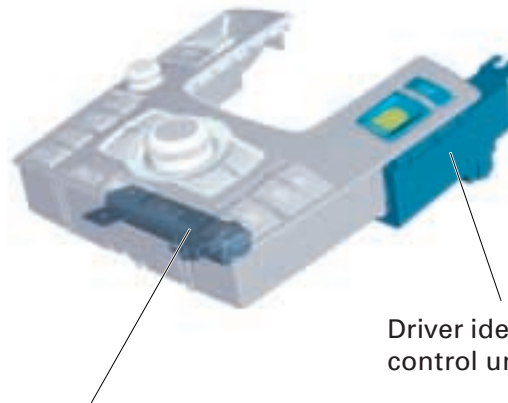

Interior aerial 1 for entry and start authorization R138

Driver identification control unit J589

The following components are integrated into the operating unit:

- Buttons and control knob for MMI operation
- Electronics for converting button and controller signals into digital data
- Aerial for remote control of MMI (optional)
- Parking brake contact switch F321
- Entry and start authorization button E408
- Driver identification control unit J589 (optional)
- Interior aerial 1 for entry and start authorization R138

The multimedia operating unit E380 converts the button and control knob signals into digital information with the aid of the integrated electronics.

This information is transmitted by means of a serial interface (RS232) to the front information display and operating unit control unit J523. In addition, the control unit J523 transmits information back to the operating unit.

Protected by copyright. Copying for private or commercial purposes, in part or in whole, is not permitted unless authorised by AUDI AG. AUDI AG does not guarantee or accept any liability with respect to the correctness of information in this document. Copyright by AUDI AG.



The parking brake contact switch F321, the interior aerial 1 for entry and start authorization R138 and the driver identification control unit J589 are independent components.

Further information on these components can be found in SSP 287 – Audi A8 '03 Electrical Components.

Inputs/outputs

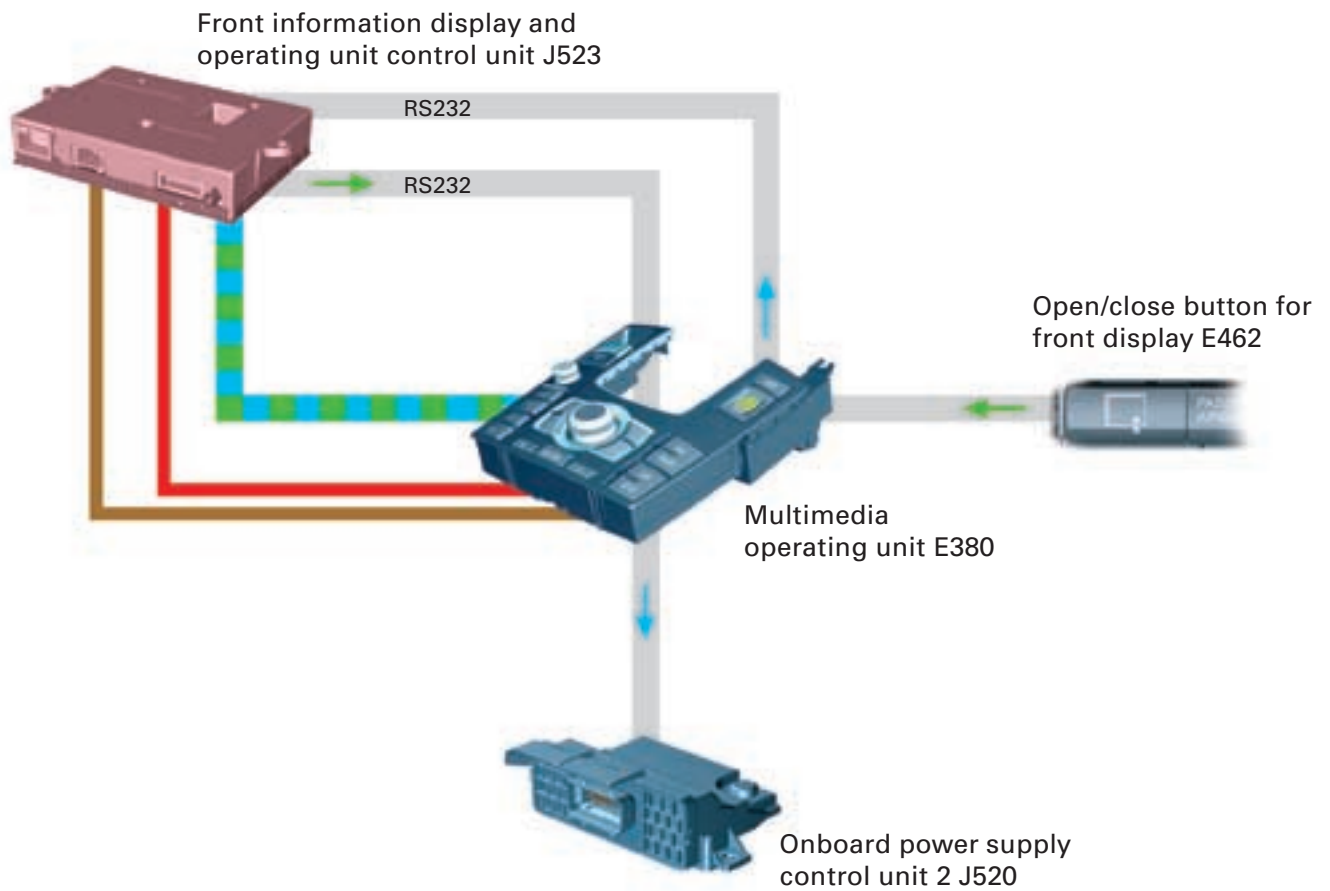

SSP293_020

Serial interface (RS232) signals:

Operating unit → Front information control unit

- Buttons
- Control knob selection
- Control knob ON/OFF, volume
- MMI remote control aerial
- Open/close button for front display E462

Front information control unit → Operating unit

- Button and controller illumination
- Message confirming reception of button and controller signals

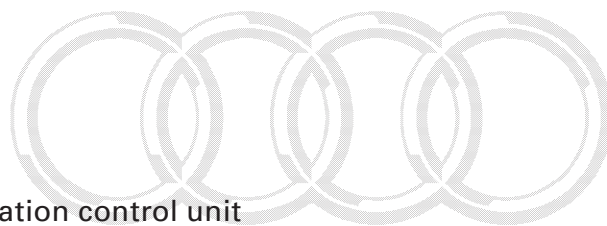

Audi

Copyright © 2013 Audi AG. All rights reserved. Copying for private or commercial purposes, in part or in whole, is not permitted unless authorised by AUDI AG. AUDI AG does not guarantee or accept any liability with respect to the correctness of information in this document. Copyright by AUDI AG.

erWin 

Serial interface (RS232)

"Serial interface" is a computer engineering term and means that digital information is transmitted consecutively (serially). The designation RS232 denotes the data transmission standard.

The information is only transmitted in one direction per wire. Two wires are therefore required for exchange of data between two control units.

The plug connection at the control unit for data reception is abbreviated **RX** (receive).

The plug connection for data transmission is designated **TX** (transmit).

On actuating a button or controller, the serial interface is monitored by the control unit J523 self-diagnosis.

An entry is made in the fault memory if the exchange of data is not OK.

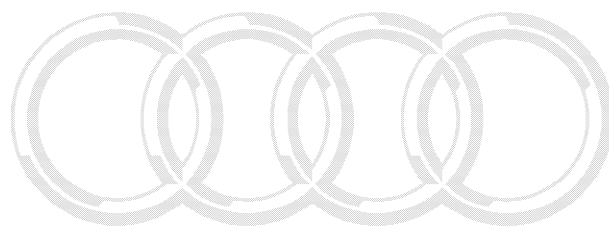

Audi

Protected by copyright. Copying for private or commercial purposes, in part or in whole, is not permitted unless authorised by AUDI AG. AUDI AG does not guarantee or accept any liability with respect to the correctness of information in this document. Copyright by AUDI AG.

erWin 

Infotainment

Open/close button for front display E462

The button is integrated into the operating unit in front of centre console E461.

The wake-up process for the MOST and convenience CAN bus systems takes roughly 3 - 4 seconds.

This results in delayed opening up of the front display unit if the bus systems are in sleep mode.

The operating unit therefore transmits the signal to the onboard power supply control unit 2 J520 on two paths.

1. Bus systems active

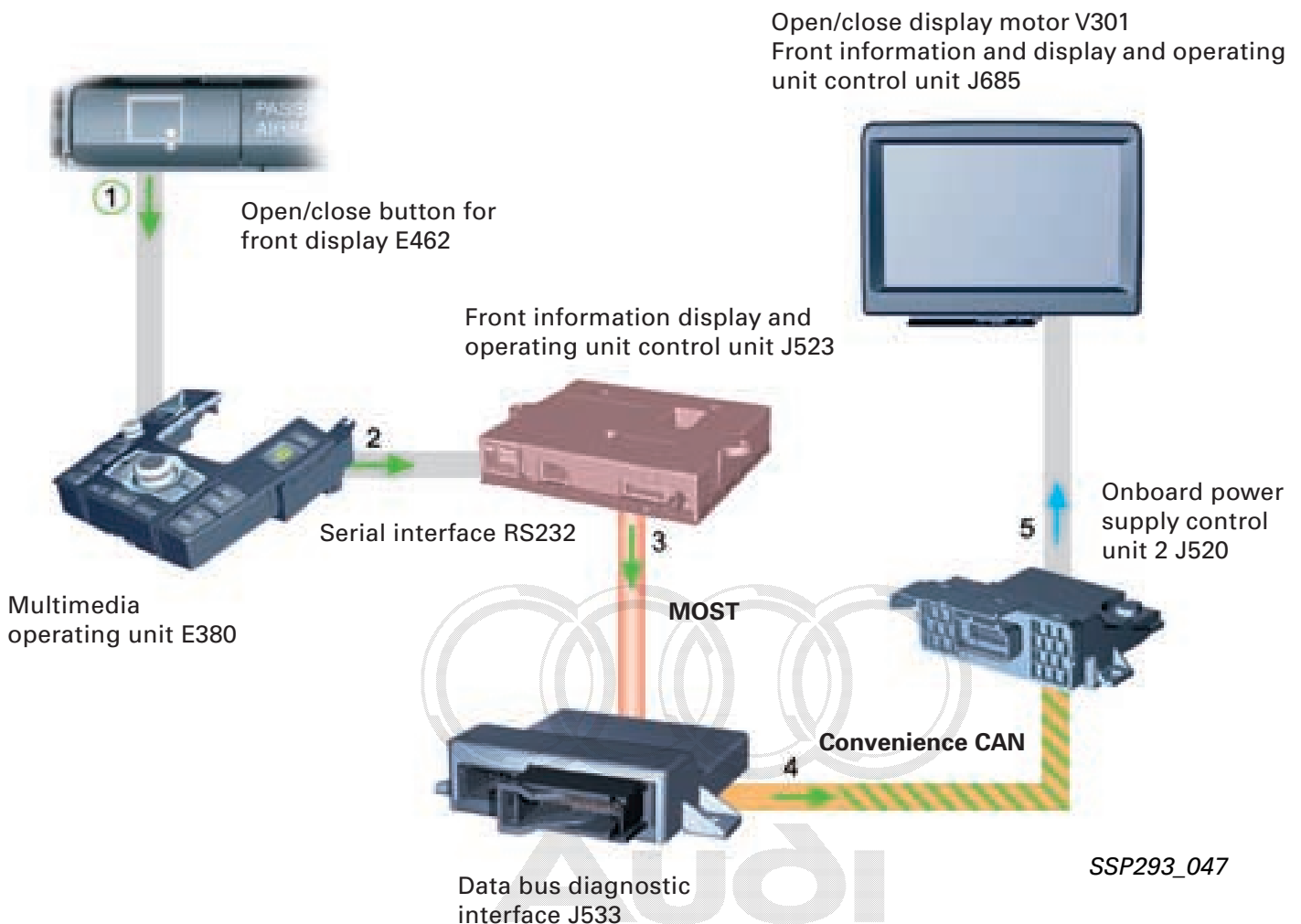

Protected by copyright. Copying for private or commercial purposes, in part or in whole, is not permitted unless authorised by AUDI AG. AUDI AG does not guarantee or accept any liability with respect to the correctness of information in this document. Copyright by AUDI AG.



2. Bus system sleep mode

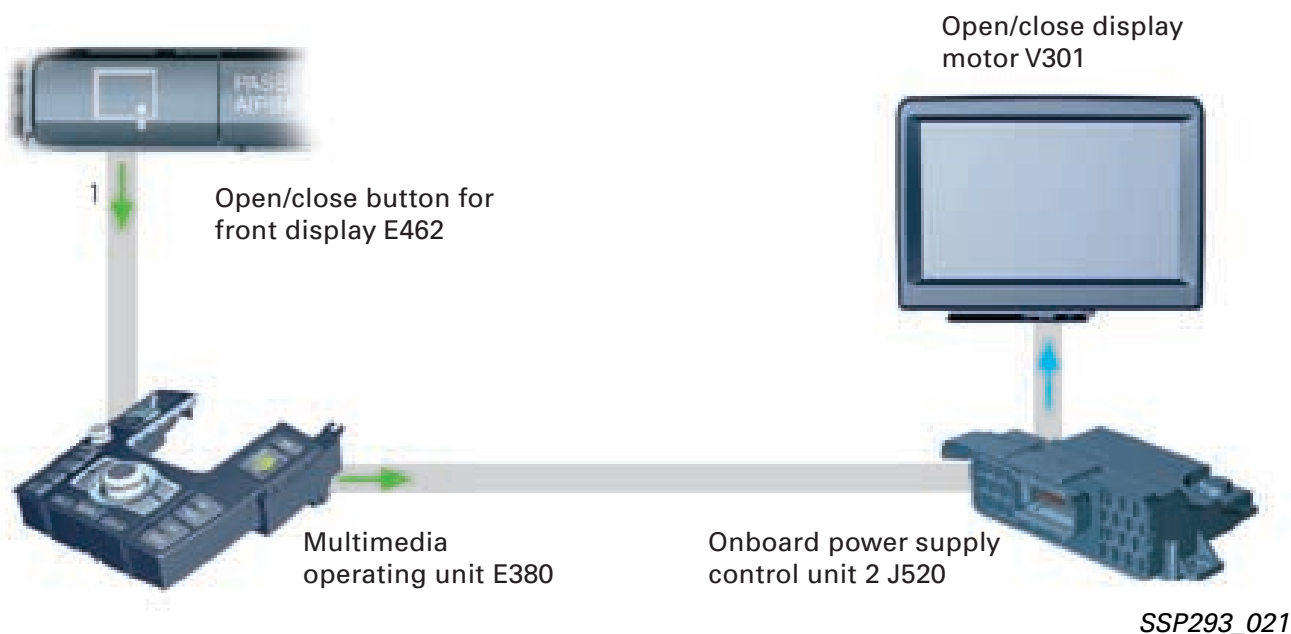

Closing of the display by pressing the open/close button for front display E462 requires data transmission by way of the bus systems.

Wake-up wire

The wake-up wire is bidirectional.

If a button is pressed with the bus systems in sleep mode, the operating unit transmits a once-only wake-up pulse to the front information display and operating unit control unit J523 to start the system.

If the infotainment system is activated by a different wake-up procedure, the control unit transmits a wake-up pulse to the operating unit to activate its electronics.

Diagnosis

Address word 07 - Control and display unit

Fault memory entries

Fault memory entries are made in the event of

- Problems with data transmission between operating unit and control unit
- Sticking of or short circuit in one or more operating unit buttons
- Sticking of or short circuit in "Open/close display unit" button

in the fault memory of the control unit J523.

Measured value blocks

The statuses of the buttons and control knob in the operating unit as well as the "Open/close display unit" button can be shown in the measured value blocks.

Protected by copyright. Copying for private or commercial purposes, in part or in whole, is not permitted unless authorised by AUDI AG. AUDI AG does not guarantee or accept any liability with respect to the correctness of information contained herein. Copyright by AUDI AG.

Adaption

The brightness of the button illumination can be adjusted using the adaption function.





Multi-function steering wheel and display in dash panel insert

The Audi A8 '03 is fitted with a multi-function steering wheel as standard. It offers the driver tiptronic® operation as well as voice control and volume regulation. In addition it makes the functions of the dash panel insert display available to the driver.

Consequently, there is no need for the driver to take a hand off the steering wheel to make use of functions such as telephone, navigation, audio source selection or driver information system DIS and all the necessary information is provided in the driver's field of vision. This represents a major contribution to increased road safety and convenience.

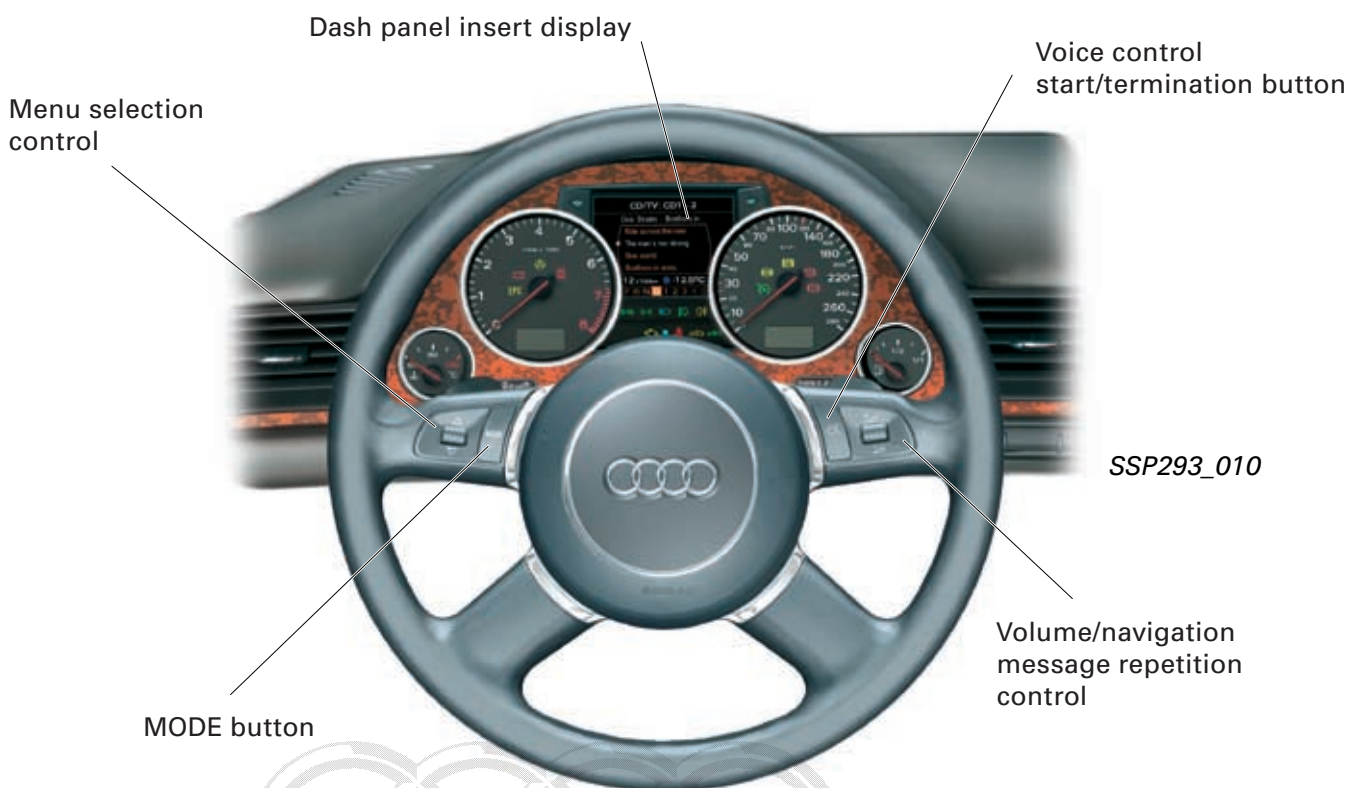

MODE button

The driver selects the appropriate menu by pressing the MODE button several times.

Menu selection control

The driver selects the required menu item by turning the control.

Selection is confirmed by pressing the control.

Volume/navigation message repetition control

The driver sets the volume by turning the volume control. After pressing the control, the last navigation system voice message is repeated.

Display in dash panel insert

Depending on steering wheel button operation, the driver is presented with the selection menus for radio station, CD track and telephone address book. Navigation information is also presented on the display.

Multi-function steering wheel signal transmission

The operating unit in the steering wheel is a LIN slave control unit.

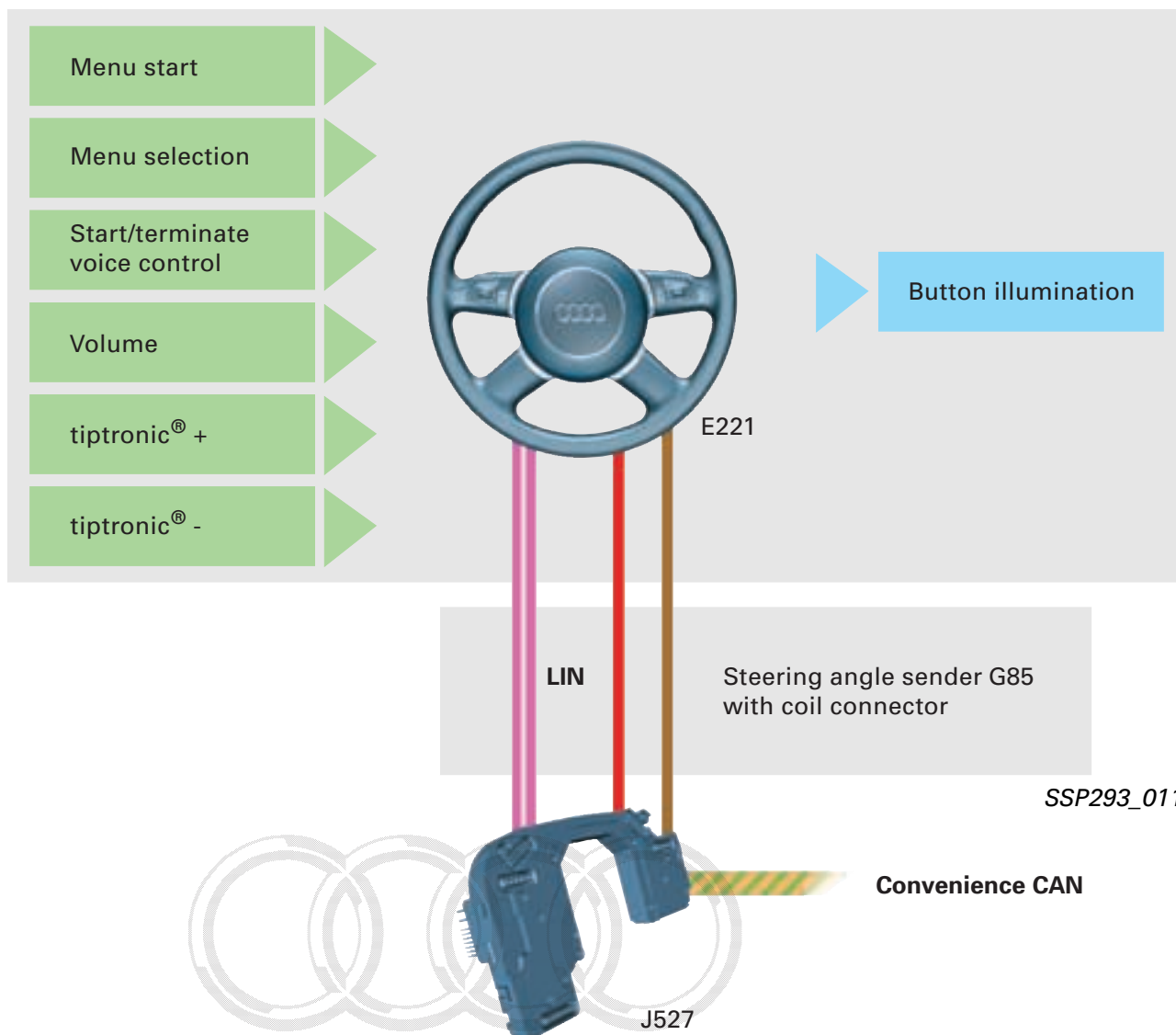

The operating unit in steering wheel E221 detects the steering wheel button and control signals and converts these into digital information.

The digital information is transmitted with the aid of a LIN bus wire in the coil connector of the steering angle sender G85 to the steering column electronics control unit J527.

The steering column electronics transmits the information from the LIN bus to the convenience CAN.

The multi-function steering wheel information is distributed by the data bus diagnostic interface J533 to the other bus systems in accordance with the functions concerned.

The control units implement the corresponding functions.

Infotainment

Example: Switching radio station by way of multi-function steering wheel

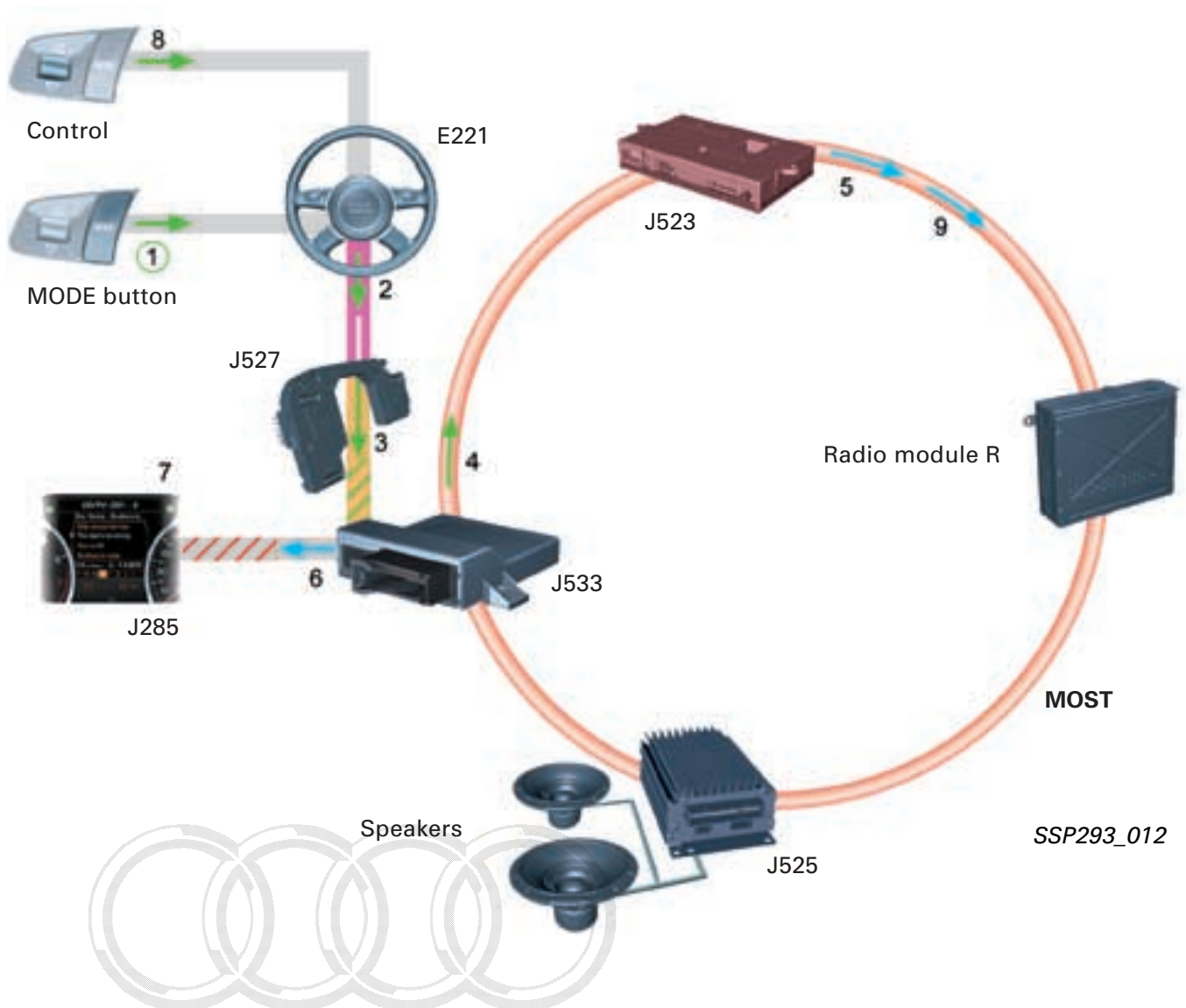

SSP293_012

1 The driver presses the MODE button several times to call up the desired selection menu in the dash panel insert display J285.

2 Each button signal is converted by the operating unit in steering wheel E221 into digital information.

The operating unit transmits this information by way of the LIN bus to the steering column electronics control unit J527.

3 The steering column electronics control unit J527 integrates the "MODE button pressed" information into a convenience CAN message.

4 The data bus diagnostic interface J533 reads the information on the convenience CAN and transmits it on the MOST bus to the front information display and operating unit control unit J523.

- | | | |
|--|--|--|
| | | |
|--|--|--|
- 5 Following reception of each "MODE button pressed" signal, J523 transmits the graphics data for presentation of the next selection menu in the display of the control unit with display in dash panel insert J285 to the MOST bus.
 - 6 The data bus diagnostic interface J533 transmits this information to the dash panel insert CAN.
 - 7 The dash panel insert reads this information and presents the corresponding selection menu in the display.



Procedures 1 to 7 are repeated each time the MODE button is pressed until the radio station selection menu appears on the dash panel insert display.

- 8 The driver selects the desired radio station by turning the left control. Each turn updates the dash panel insert display.

Selection is confirmed by pressing the control.

Signal transmission from the operating unit in steering wheel E221 to the front information display and operating unit control unit J523 and from the control unit J523 to the dash panel insert is implemented in the manner described above.

- 9 The front information display and operating unit control unit J523 starts playing of the selected radio station. For further information, refer to Page 52.

Protected by copyright. Copying for private or commercial purposes, in part or in whole, is not permitted unless authorised by AUDI AG. AUDI AG does not guarantee or accept any liability with respect to the correctness of information in this document. Copyright by AUDI AG.



Self-diagnosis

Address word 16 - Steering column electronics

When the convenience CAN is active, the steering column electronics control unit J527 checks

- communication on LIN bus wire to operating unit in steering wheel E221
- tiptronic® and MMI buttons as well as controls and illumination for short circuit and open circuit

A corresponding fault memory entry is made in the event of malfunction.

Encoding

The steering wheel equipment must be stated in the steering column electronics control unit encoding.

Measured value blocks

The measured value blocks display

- Signal inputs of buttons and controls
- Hardware and software version of operating unit in steering wheel E221
- Status of communication on LIN bus
- Measured value of heated steering wheel sensor G428

Protected by copyright. Copying for private or commercial purposes, in part or in whole, is not permitted unless authorised by AUDI AG. AUDI AG does not guarantee or accept any liability with respect to the correctness of information in this document. Copyright by AUDI AG.

Control element test

The steering wheel heating and button illumination are switched on by way of the control element test for checking.

Sound System

Introduction

Even the standard version of the new digital sound system in the Audi A8 '03 achieves a quality of sound dynamics and acoustics previously unattained in series systems.

The optional Bose® Surround sound system offers an even better overall effect, volume adjustment to compensate for vehicle noise (AudioPilot™) and unique surround sound.

Digital sound system

The digital sound system makes use of 5 audio channels.

The stereo signals are distributed over 5 channels by the digital system and reproduced by 9 speakers.

This dispersion of audio signals gives listeners the impression of being in the middle of a concert hall.



Standard sound system

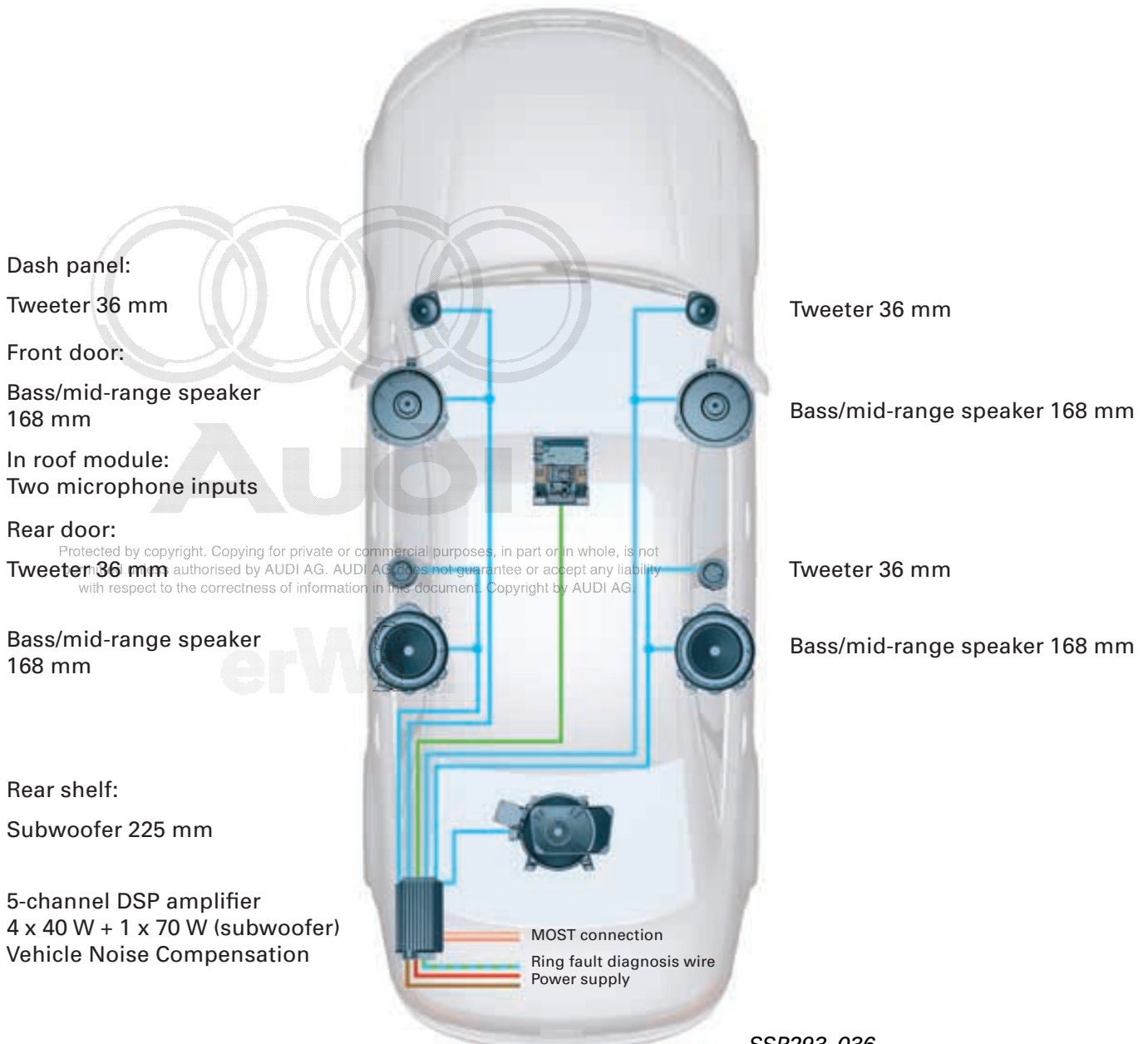

SSP293_036

Sound System

New sound settings

In addition to the familiar sound settings, the user can make certain new adjustments to the sound system with the help of the MMI.



SSP293_042

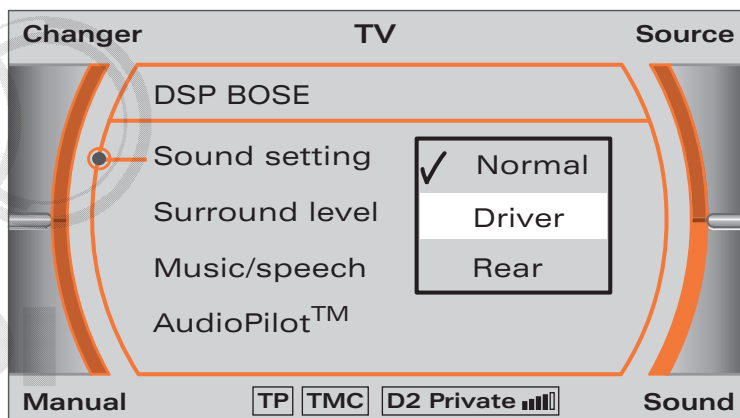

Protected by copyright. Copying for private or commercial purposes, in part or in whole, is not permitted unless authorised by AUDI AG. AUDI AG does not guarantee or accept any liability with respect to the correctness of information in this document. Copyright by AUDI AG.

SSP293_060

Sound setting



- Normal: The sound system sets the speakers to optimum reproduction for all seats.
- Driver: The sound system is set specially for the driver.
- Rear: The sound reproduction is optimised for the rear seats.

Music/speech

Clarity of speech reproduction requires different sound settings to those for music reproduction.

As an additional service, RDS radio stations transmit the corresponding encoded information together with the signal for spoken broadcasts (news, traffic bulletins).

If the music/speech changeover function is active, the sound system reproduces the spoken broadcasts with a special speech tuning stored in the software.

New feature: Speed-dependent volume adaption (GALA)

The digital sound system in the Audi A8 '03 is fitted with an advanced version of the familiar speed-dependent volume adaption function (GALA).

The new GALA function is integrated into the digital sound package control unit J525. It uses the vehicle speed to calculate the typical background noise level.

On the basis of the background noise level established, the control unit only increases the volume of the frequency bands affected.



As the typical background noise level differs depending on whether a vehicle is fitted with a petrol or diesel engine, the engine version must be set in the encoding.

Audi

Protected by copyright. Copying for private or commercial purposes, in part or in whole, is not permitted unless authorised by AUDI AG. AUDI AG does not guarantee or accept any liability with respect to the correctness of information in this document. Copyright by AUDI AG.

erWin 

Sound System

Digital Bose® Surround sound system (optional)



Dash panel:

Left main channel 70 mm
Centre (mid-range/treble/
bass speaker) 70 mm

Front door:

Woofer 200 mm

In roof module:

Two microphone inputs

Rear door:

Tweeter 36 mm

Bass/mid-range speaker
168 mm

Protected by copyright. Copying for non-commercial purposes, in part or in whole, is not permitted unless authorised by AUDI AG. AUDI AG does not guarantee or accept any liability with respect to the correctness of information in this document. Copyright by AUDI AG.

Rear shelf:

Subwoofer 300 mm
2 x Surround (mid-range/treble/
bass speaker) 8 mm

8-channel DSP amplifier
6 x 25 W + 2 x 50 W (front woofer)
+ 1 x line-out output for active
subwoofer, AudioPilot™



Right main channel 70 mm

Woofer 200 mm

Tweeter 36 mm

Bass/mid-range speaker
168 mm

SSP293_037

The digital Bose® Surround sound system in the Audi A8 '03 makes use of 8 audio channels.

Front main channel speakers R26, R27

The left and right main channel speakers in the dash panel transmit

- the mid-range and high frequencies
- the music and all video mode sounds intended to be emitted from the front but not directly from the centre

Centre channel speaker R158

The function of the centre channel speaker R158 is visual and audio harmonisation in video mode. In other words, it permits the assignment of sound to images, thus creating the impression that the actors' voices are coming from the centre of the screen.

For music reproduction, the digital Bose® Surround sound system uses the centre speaker to achieve the all-round effect. Listeners have the impression of being in the centre of a concert hall regardless of whether they are on the right or left side.

Bass channel in front doors R21 and R23

The passive woofers in the front doors reproduce the low audio frequencies in the front area of the passenger compartment and thus amplify the full bass effect in the vehicle.

Two main channels at rear

The rear-door mid-range/bass speakers R15, R17 and the tweeters R14, R16 act in the same way as the front main channels to reproduce music and sound for the rear area of the passenger compartment.

Surround channel

The two mono surround speakers R150 achieve the all-round acoustic effects. They are installed beneath the rear shelf on the right and left. As both speakers reproduce exactly the same sound, they are connected in series.

Rear subwoofer

The active rear subwoofer reproduces the bass tones and thus reinforces the full bass impression during music reproduction. The subwoofer is actuated via a line-out output. The external subwoofer amplifier boosts this incoming signal to 100 W.



The surround sound function is only available for purely stereo sources such as CD and DVD.



The surround sound function is not activated in radio and TV mode, as the input signals are sometimes only mono.

The acoustic coordination of all speakers is essential to the reproduction of surround sound. If one of the speakers does not reproduce the correct tones due to malfunction, the surround sound effect will be considerably impaired.



Sound System

AudioPilot™

The AudioPilot™ function provides compensation for vehicle background noise by increasing the volume of the frequency band affected.

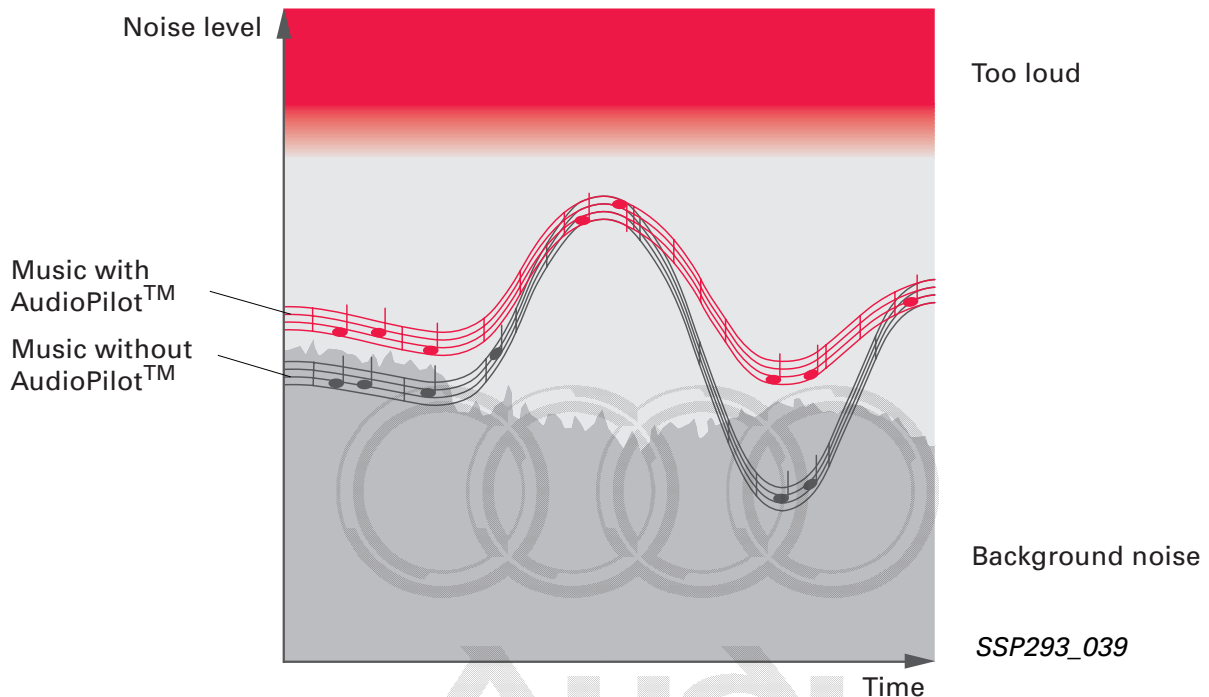

The background noise is picked up by the microphones in the roof module and evaluated by the digital sound package control unit J525.

The problem with background noise detection is to distinguish this from music or speech.

Example: The noise of the AC fresh-air blower cannot be distinguished by the AudioPilot™ from the sound patterns of music.

The digital sound package control unit J525 thus requires the following additional information:

- Speed of AC fresh-air blower
- Engine version

The speed of the fresh-air blower enables the digital sound package control unit J525 to recognise the sound picked up by the microphones as background noise and provide compensation for this.

The engine version enables the digital sound package control unit to recognise the engine background noise picked up by the microphones and to increase the volume of the frequency bands affected.

As with series equipment, the engine version – diesel/petrol engine – must be set in the encoding.

Bose® Surround sound system settings

In addition to the sound settings described above, the Bose® Surround sound system features sound level adjustment.

With this function, users can select the area of the passenger compartment for which surround sound reproduction is to be adjusted.

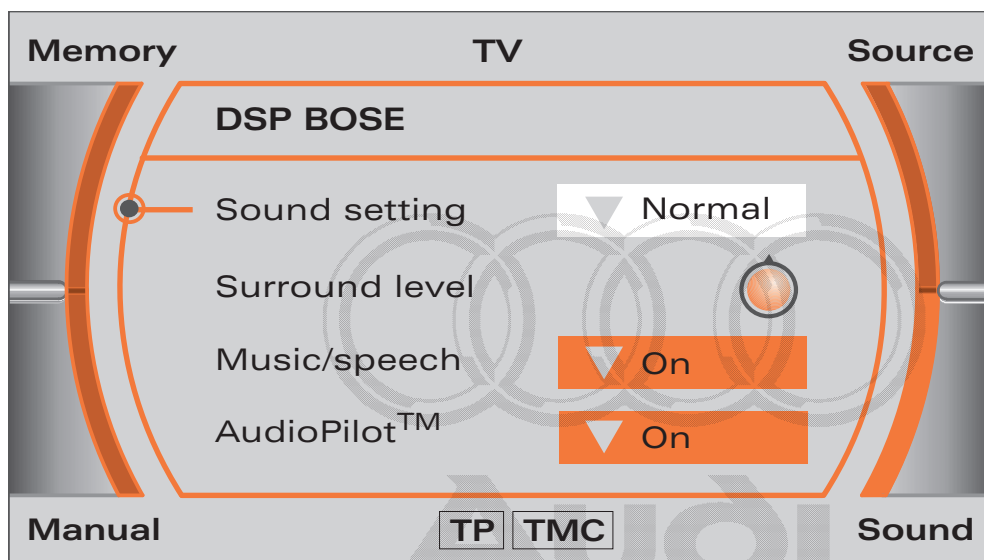

SSP293_041

Protected by copyright. Copying for private or commercial purposes, in part or in whole, is not permitted unless authorised by AUDI AG. AUDI AG does not guarantee or accept any liability with respect to the correctness of information in this document. Copyright by AUDI AG.



Sound System

Audio management distributed function

The front information display and operating unit control unit J523 is the audio master in the infotainment system of the Audi A8 '03.

This means that the volume and sound settings made by the user are stored separately for the individual modes in control unit J523.

The sound settings are made by the user either with the corresponding mode activated or with the aid of the "Sound/volume settings" setup menu in the MMI.

These settings are stored on a personalised basis (optional) when the infotainment system is switched off.

The key-specific settings are activated by way of the remote control key recognition function in the entry and start authorisation control unit J518.

In vehicles with one touch memory (fingerprint, optional), the personalised settings are activated by way of the driver's fingerprint. Further information can be found in SSP 287 – Audi A8 '03 – Electrical Components.

The illustration shows the different modes and the transmission paths for the information required for volume control.

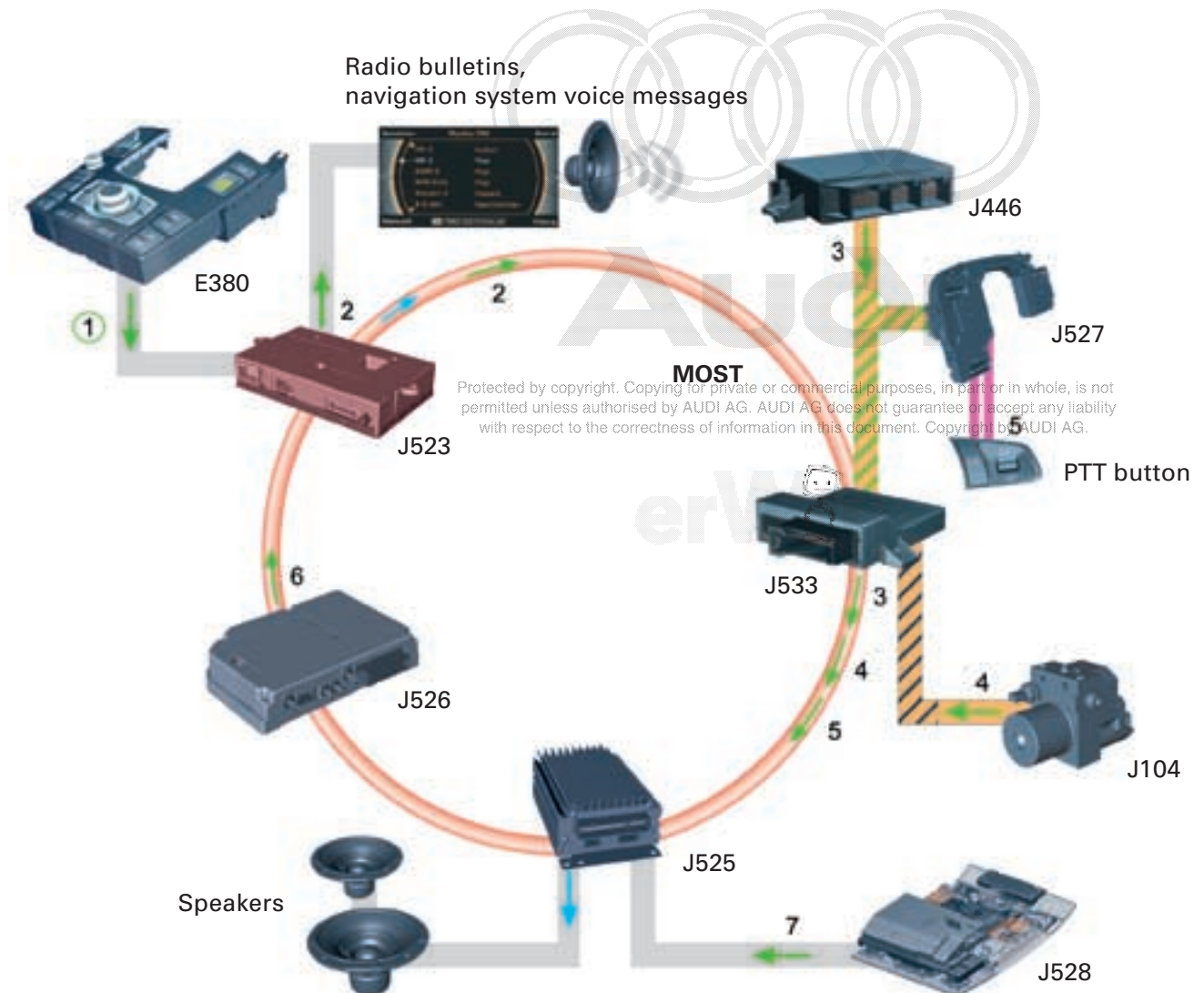

The audio signals are transmitted directly by way of the MOST bus from each audio source to the digital sound package control unit J525.

1 Entertainment:

The volume and sound settings for the entertainment functions can be made by the user on the multimedia operating unit E380 and are stored separately and on a personalised basis (optional) for each mode.

2 Information:

In the event of emergency and traffic messages, the entertainment functions and voice control system are interrupted. Traffic messages are output on the driver's side, emergency announcements on all speakers.

During navigation messages, the volume of the entertainment functions is reduced. Navigation messages are output on the driver's side.

3 Acoustic Parking System (APS):

When the APS system is active (parking aid control unit J446), the volume of the entertainment systems is reduced.

4 Vehicle speed:

The "vehicle speed" information is transmitted by the ABS with EDL control unit J104 with the aid of the drive system CAN via the data bus diagnostic interface J533 and the MOST bus to the front information display and operating unit control unit J523.

This information is required for the GALA function.

5 Control:

Activation of the dialog system (SDS) by way of the PTT button in the steering wheel reduces the volume of the entertainment functions. Active traffic or emergency messages are terminated. Output is on the driver's side.

6 Communication:

When telephoning via the telephone/telematics control unit, the volume of the entertainment functions is reduced.

The driver has the option of setting the telephone output as required between front and rear.

7 Microphone module:

The microphones are used for the AudioPilot™ function (optional).

The microphone signals are transmitted in the form of digital information to the MOST bus.

The number of microphones depends on vehicle equipment.

Protected by copyright. Copying for private or commercial purposes, in part or in whole, is not permitted unless authorised in writing by Audi AG. All rights reserved. Audi AG is not liable with respect to the correctness of information in this document. Copyright by AUDI AG.

Further information on the microphones can be found in the following.



Sound System

Microphones

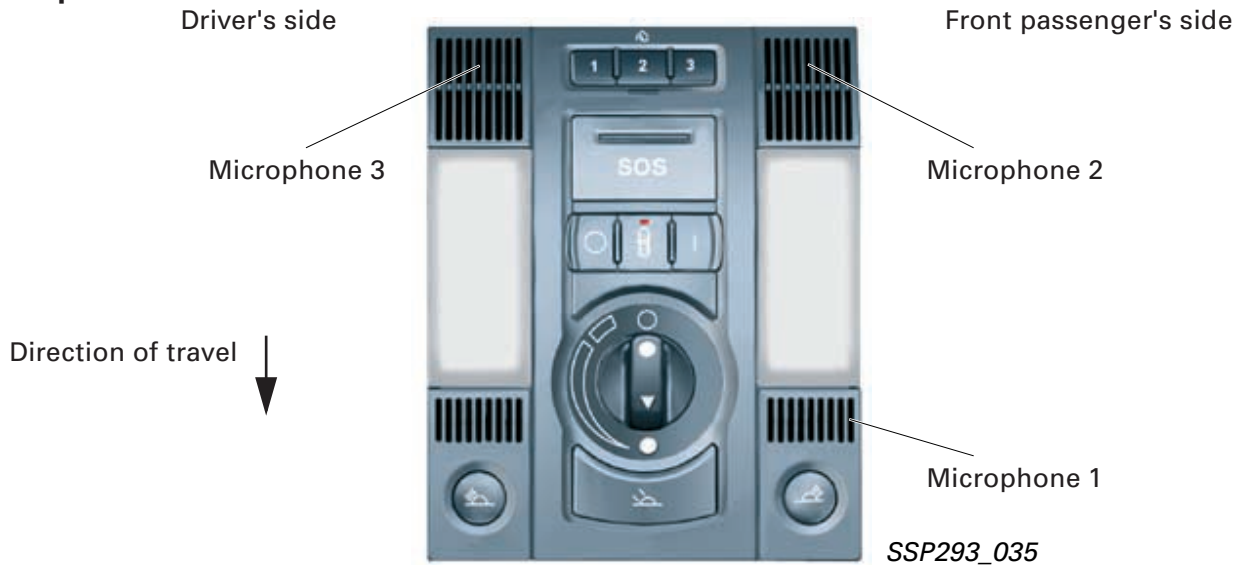

An Audi A8 '03 with the full range of equipment has three microphones accommodated in a unit in the front roof module. The number of microphones depends on vehicle equipment and must be observed on component replacement.

Depending on equipment version, the analog microphone signals are converted into digital signals in the digital sound package control unit J525 or telephone/telematics control unit J526 and transmitted by way of the MOST bus. The table lists the available options.

SDS	Telephone/telematics	Microphone connected to	Microphone audio data MOST bus
No	No	DSP: No microphone fitted Bose® DSP: Microphone 2 connected to DSP	None
No	Yes	DSP: Microphone 1 connected to telephone/telematics Bose® DSP: Microphone 1 connected to telephone/telematics; Microphone 2 connected to DSP	With Bose® DSP → TEL
Yes	No	Microphones 1 and 2 connected to DSP	DSP → SDS
Yes	Yes	Microphones 2 and 3 connected to DSP Microphone 1 connected to telephone/telematics Microphone signals following processing by echo suppression in SDS control unit	DSP → SDS TEL → SDS SDS → TEL

Diagnosis

Address word 47 - Digital sound package

Fault memory entries

The following result in corresponding fault memory entries

- Supply voltage undershot/exceeded
- Open circuit/increased attenuation in MOST bus
- Short circuits or open circuits in speakers
- Short circuits or open circuits in microphones (optional)
- Loss of communication with control units by way of bus systems
- Activation of component protection

in the digital sound package control unit J525.

Measured value blocks

The measured value blocks display

- Power supply
- MOST address
- MOST identifier (type of unit)
- Status of ring fault diagnosis wire
- Status of AF mute connection
- Vehicle speed
- Speed of cooling blower (only Bose®)
- Amplifier temperature
- Manufacturer's data (serial number, etc.)
- Voltages at microphone inputs (optional)

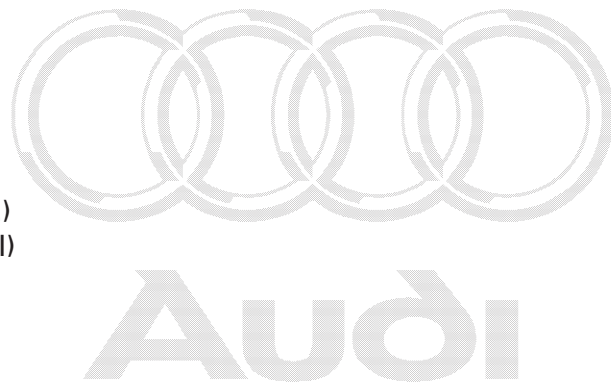

Protected by copyright. Copying for private or commercial purposes, in part or in whole, is not permitted unless authorised by AUDI AG. AUDI AG does not guarantee or accept any liability with respect to the correctness of information in this document. Copyright by AUDI AG.



Radio Module

Radio module R

The radio module contained in the basic equipment of the Audi A8 '03 permits integration of additional systems into the infotainment system.

Plug-in positions are additionally provided for three modules, one of which is used for the language input control unit J507 plug-in module.

The function of the radio module is to ensure analog radio station reception, to convert aerial signals into digital audio signals and to transmit these by way of the MOST bus to the digital sound system.

As with the second generation symphony radio, the radio module has two integrated radio tuners. Information on this topic can be found in SSP 254 – Audi A4 '01 Technical Features.

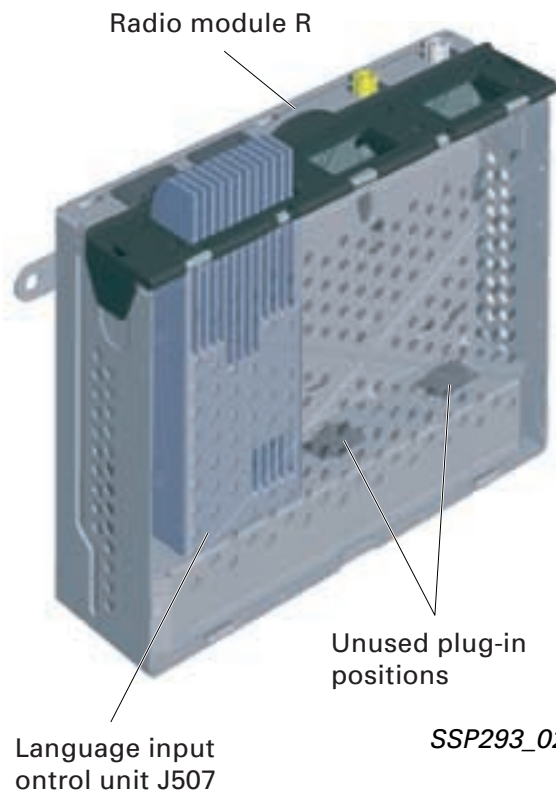

Fitting location

The radio module is installed on a base plate on the left of the luggage compartment.

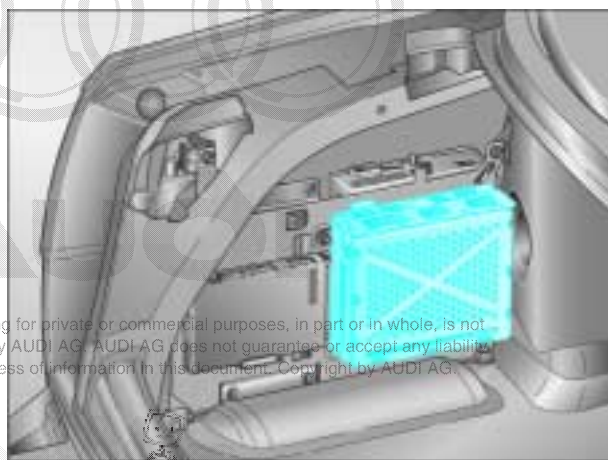

Input/output signals

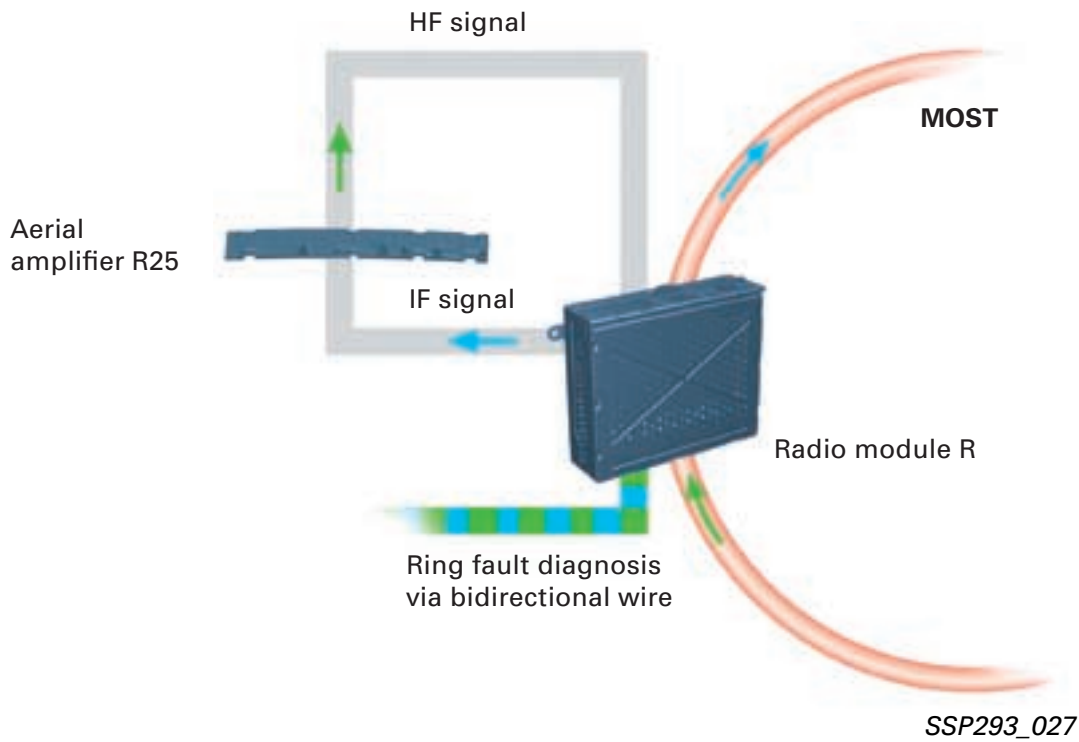

Radio stations are received by way of four FM aerials integrated into the rear window and one AM aerial.

The mode of operation of the aerial amplifier R25 with integrated aerial diversity corresponds to that of the aerial module in the Audi A4 '01.

All the control signals and the audio signals converted into digital information are transmitted by way of the MOST bus.

Protected by copyright. Copying for private or commercial purposes, in part or in whole, is not permitted unless authorised by AUDI AG. AUDI AG does not guarantee or accept any liability with respect to the correctness of information in this document. Copyright by AUDI AG.

erWin 



Radio Module

"Radio listening" distributed functions

The front information display and operating unit control unit J523 is the master control unit for this function.

The reception data of up to 20 radio stations are stored in the control unit and listed in the RADIO main menu in the front information display unit.

Radio stations which have been stored but are not currently being received appear in grey.

6 radio stations which have been listened to for at least 45 seconds are displayed at the top of the list and stored on a user-specific basis. New radio stations received replace those which have not been listened to for the longest.

The display sequence is based on the Programme Identifier (PI) code. This enables radio stations belonging to one group to be displayed in direct succession. Information on the PI code can be found in SSP 147 – Radio Systems '94.

The station category (PTY code) is also shown in the list. Users can select the desired station categories in the radio function setup menu.

Like the PI code, the PTY code is integrated into the RDS data and contains additional information on the set radio station.

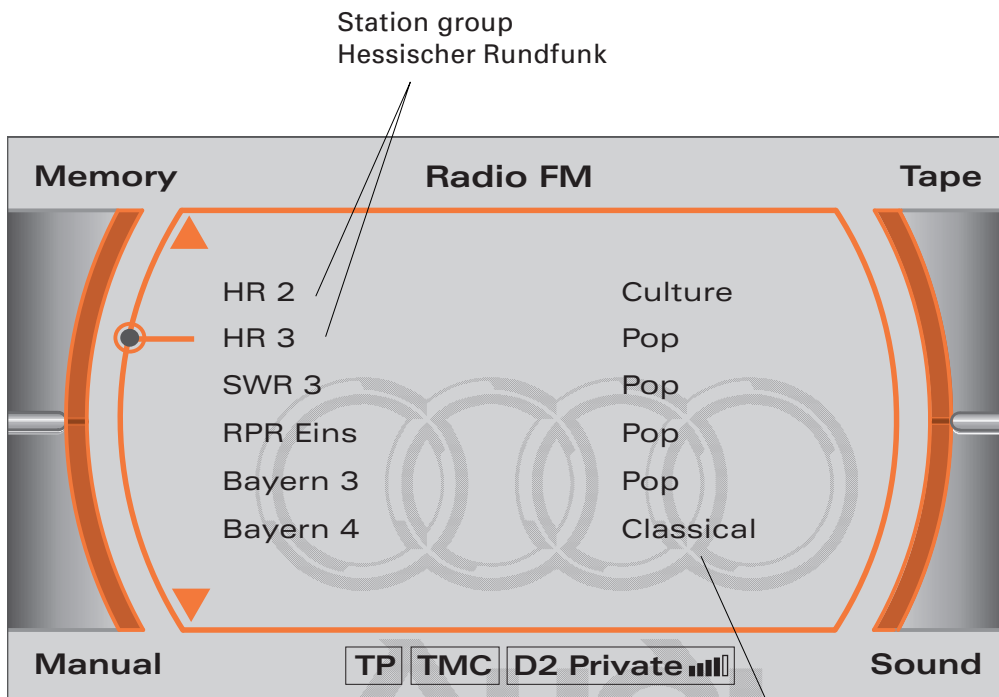

SSP293_038

Protected by copyright. Copying for private or commercial purposes, in part or in whole, is not permitted unless authorised by AUDI AG. AUDI AG does not accept any responsibility with respect to the correctness of information in this document. Copyright by AUDI AG.

Station category using
PTY code



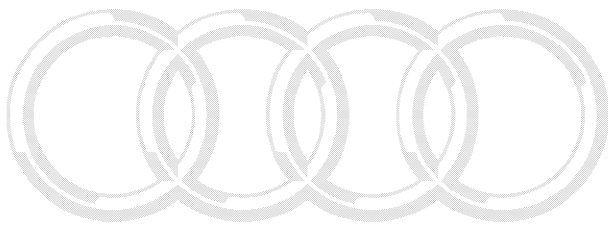

Audi

Protected by copyright. Copying for private or commercial purposes, in part or in whole, is not permitted unless authorised by AUDI AG. AUDI AG does not guarantee or accept any liability with respect to the correctness of information in this document. Copyright by AUDI AG.



Radio Module

The front information control unit retains the last user-specific status (display open/closed; radio/CD/TV etc.) prior to switch-off; When switched on again, the stored status is reactivated.

The illustration shows the sequence of operations when switching on the infotainment system in radio mode in a vehicle with one touch memory system (optional).

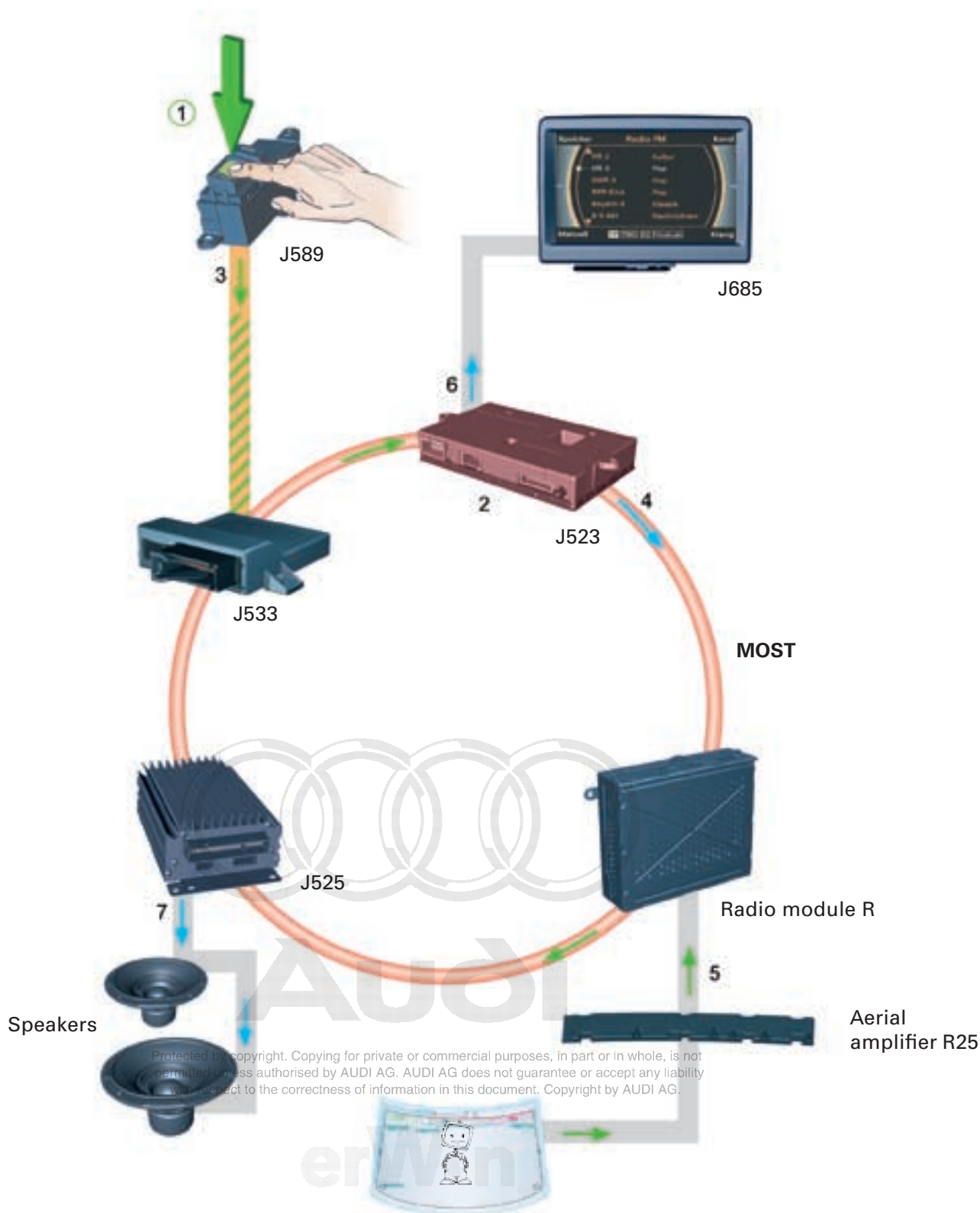

Aerials FM1 - FM4

SSP293_024

- 1 The user provides identification by way of the entry and start authorisation button E408.
- 2 The last user-specific status before switching off the system is stored in the front information display and operating unit control unit J523.
- 3 The "driver identification" information is transmitted by the driver identification control unit J589 to the convenience CAN. By way of the data bus diagnostic interface J533, this information is also available to all other control units involved in memory control.

In the example shown, "RADIO" had been the last active mode for this user and the display unit had been open.

Opening of the display unit is as described in the "Open/close display unit button" Section.

- 4 The front information display and operating unit control unit J523 transmits an enquiry to the radio module R:
 - Which radio stations are currently being received?
 - Which transmission channels are being used for audio transmission?
- 5 The radio module responds with the required information and starts to transmit the synchronous data for audio transmission to the MOST bus.

- 6 The front information control unit transmits the graphics data to the front information display unit.

The corresponding station list is presented in the display unit.

In addition, the front information control unit transmits the following information

- Command for reproduction of radio transmission channels
- Volume (user-specific)
- Sound setting (user-specific)
- Muting OFF

to the digital sound package control unit J525.

- 7 The digital sound package control unit converts the digital audio transmission data into analog signals and reproduces these via the speakers. The user hears the radio station.



Audi

Protected by copyright. Copying for private or commercial purposes, in part or in whole, is not permitted unless authorised by AUDI AG. AUDI AG does not guarantee or accept any liability with respect to the correctness of information in this document. Copyright by AUDI AG.



Radio Module

Diagnosis

Address word 56 - Radio

Encoding

The encoding is used to set

- The country version for adaption of frequency bands
- The infotainment system configuration to ensure communication by way of the data bus systems

Control element test

In the control element test, a test tone with a frequency of 100 Hz is transmitted by the radio module R to the digital sound package control unit J525.

The digital sound system reproduces the test tone via the speakers.

This permits checking of the audio data transmission by way of the MOST bus.

Fault memory entries

The following situations

- Power supply undershot/exceeded
- MOST bus open circuit/increased attenuation
- Loss of communication with navigation system control unit J401
- Open circuit/short circuit in HF wire
- Open circuit/short circuit in IF connection

result in corresponding fault memory entries in the radio module.

Measured value blocks

The measured value blocks display

- Power supply
- MOST address (position in ring)
- MOST identifier (type of unit)
- Status of diagnosis wire
- Power supply and current input of aerial amplifier and aerial diversity
- Strength of current radio station reception

Protected by copyright. Copying for private or commercial purposes, in part or in whole, is not permitted unless authorised by AUDI AG. AUDI AG does not guarantee or accept any liability with respect to the correctness of information in this document. Copyright by AUDI AG.



Dialog system (SDS)

The language input control unit J507 is fitted in the radio module in the form of a plug-in module. It is a self-contained control unit with separate MOST address and address word for self-diagnosis.

The "Help" command informs the driver of the commands available on the current level. This represents a major contribution to increased road safety and ride comfort.

The functions of the familiar voice control system have been considerably extended in the Audi A8 '03 SDS.

The table provides a summary of the SDS functions.



RADIO	CD	Navigation	Address book	Telephone
VHF	Next CD	Start/stop navigation	Specify name	Enter PIN
Next station	Previous CD	Destination entry	Read out name	Call <name>
Station number 1 ... 99	CD number N	Go to <address book entry>	Find entry and make call	Private
87.5 ... 108.0 (direct frequency input)	Next track	Map settings	Navigate	Office
Play station <station name>	Previous track	Traffic news ON/OFF	Erase	Fixed network
Station name (specify)	Track number 1 ... 99	Traffic news (read out)	Call <name> (private/office/ fixed/mobile)	Mobile
Station list (read out + select)	Specify CD name		Navigate to <name>	Number <0123456789>
	CD <name> (play) 			Correct
	CD list (read out + select)			Dial
				Redial

Protected by copyright. Copying for private or commercial purposes, in part or in whole, is not permitted unless authorised by AUDI AG. AUDI AG does not guarantee or accept any liability with respect to the correctness of information in this document. Copyright by AUDI AG.

Radio Module

Voice control input/output signals

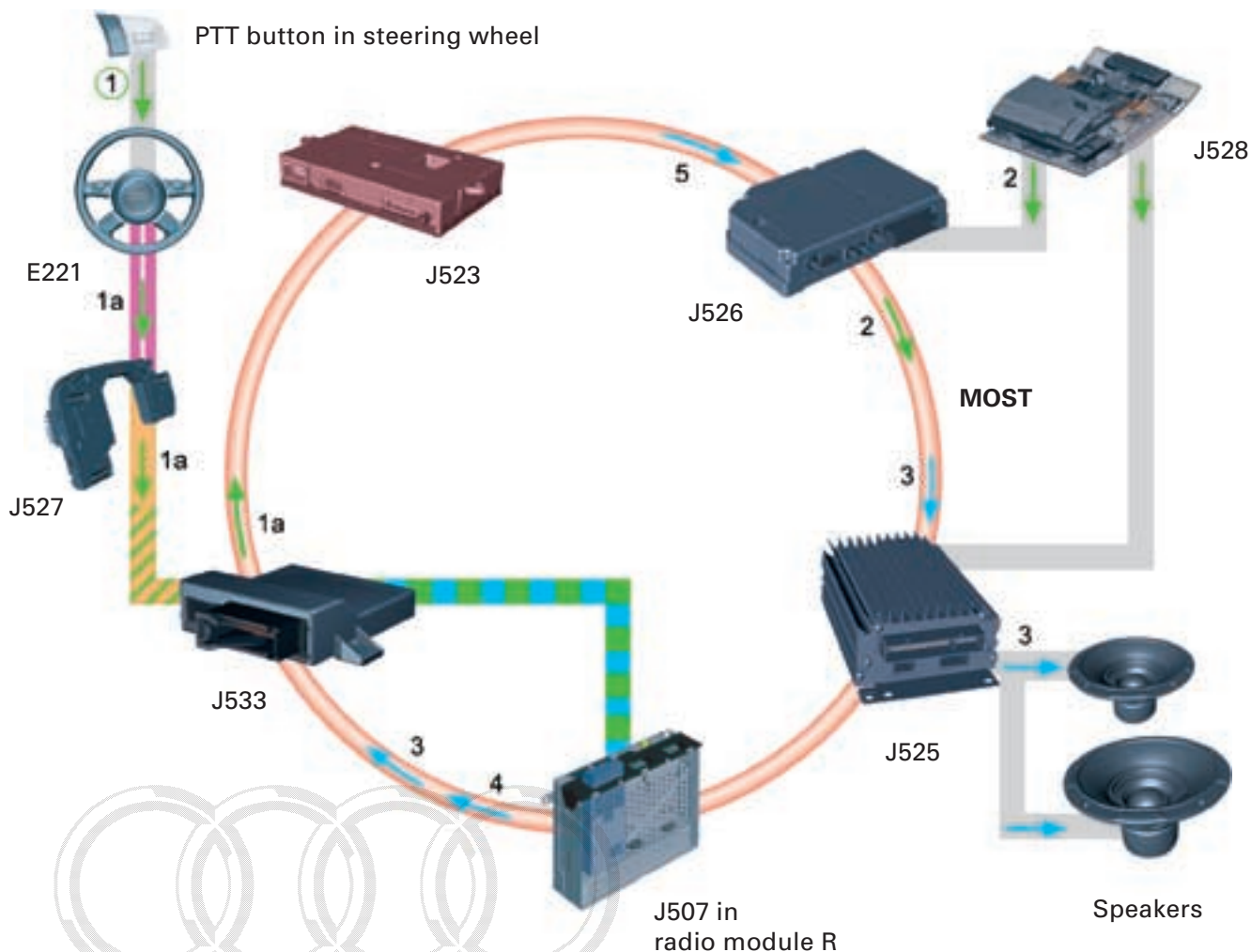

SSP293_029

E221	Operating unit in steering wheel
J507	Language input control unit
J523	Front information display and operating unit control unit
J525	Digital sound package control unit
J526	Telephone/telematics control unit
J527	Steering column electronics control unit
J528	Sunroof electronics control unit
J533	Data bus diagnostic interface

The plug-in contacts in the radio module are used for all input and output signals, as well as the power supply.

MOST bus data transmission in the radio module is by way of electrical pulses. This is made possible by

- Screening against electromagnetic interference by way of the metal case
- Short transmission path

The illustration on the left shows the input and output signal paths.

- 1 The SDS is activated by pressing the PTT button in the operating unit in steering wheel E221.
- 2 The digital sound package J525 and telephone/telematics J526 control units convert the signals from the microphone unit in the roof module into digital information and transmit this by way of the MOST bus to the language input control unit.
- 3 The dialog system speech output is achieved in the reverse direction using the digital sound package control unit.
- 4 The user requests are transmitted by the dialog system by way of the MOST bus to the front information display and operating unit control unit J523.
- 5 As infotainment master, the control unit J523 actuates the appropriate control units to implement the required functions.



The digital microphone signals are filtered by means of an elaborate software function in the language input control unit and mixed to improve recognition of voice commands.

Microphone signal processing is also active in telephone hands-free mode. The language input control unit J507 provides the telephone/telematics control unit J526 with the processed microphone signals by way of the MOST bus.

Protected by copyright. Copying for private or commercial purposes, in part or in whole, is not permitted. Audi AG does not warrant, guarantee or accept any liability with respect to the correctness of information in this document. Copyright by AUDI AG.

This considerably enhances hands-free quality.

Component protection



The language input control unit J507 is incorporated into the component protection system.

In other words, activated component protection results in restricted dialog system operation.

Radio Module

Diagnosis

Address word 67 - Voice control

Fault memory entries

The following situations

- Power supply undershot/exceeded
- MOST bus open circuit/attenuation
- Loss of communication with entry and start authorisation control unit J518
- Activated component protection

result in corresponding fault memory entries in the radio module.

Measured value blocks

The measured value blocks display

- Power supply
- MOST address (position in ring)
- MOST identifier (type of unit)
- Status of diagnosis wire
- PC board temperature
- Reception level of microphones during last command
- Last command recognised, for example "RADIO"

Control element test

This document is copyrighted by Audi AG. Copying for private or commercial purposes, in part or in whole, is not permitted unless authorised by AUDI AG. AUDI AG does not guarantee or accept any liability with respect to the correctness of information in this document. Copyright by AUDI AG.

The language input control unit performs an internal self-test in "control element test" mode. Any faults occurring are displayed.

Introduction

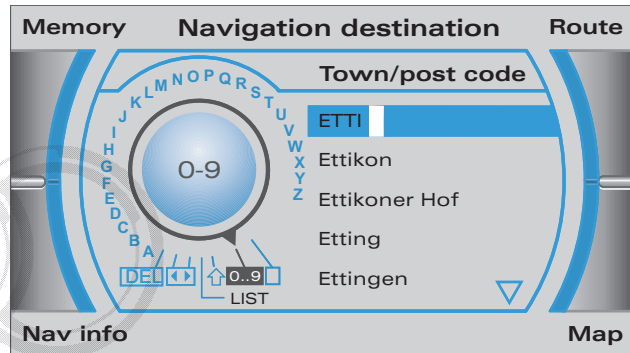
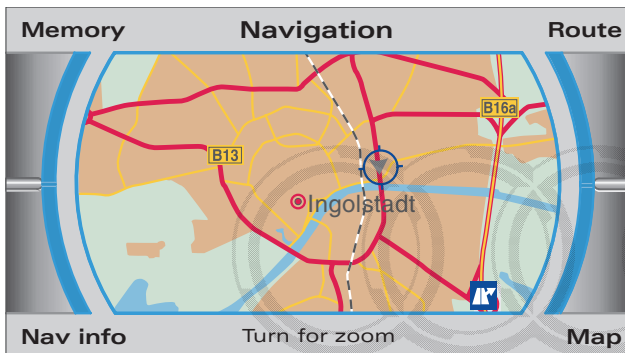
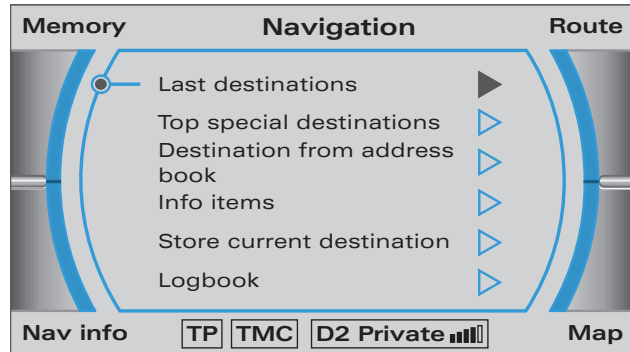
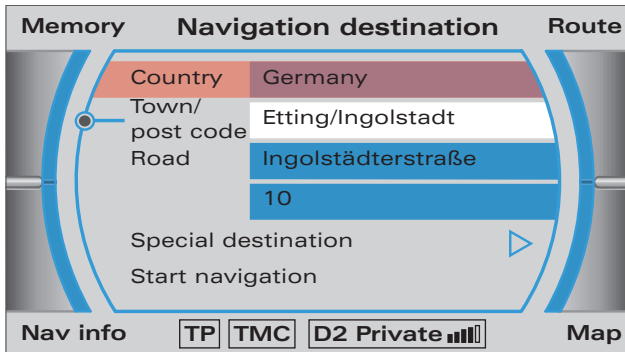

SSP293_048

The navigation system in the Audi A8 '03 permits the use of Digital Versatile Discs (DVD) as navigation system information source.

A DVD is capable of storing up to 4.7 gigabytes of data. This corresponds to roughly seven times the storage capacity of a CD-ROM.

Navigation data for several countries and additional information such as travel guide, restaurant guide and sports guide can thus be stored.

The destination input menu has been extended to include the box "Country".

Users can still also select destinations by entering the post code.

Destination entries using the dialog system are an optional feature. With this function, the name of the place or road can be given as voice command.

Address book

The "Memory" function enables users to make entries in an address book.

The following data

- Surname
- First name
- Category

and the navigation data relating to the entry are stored.



Navigation

Input/output signals Navigation system control unit J401

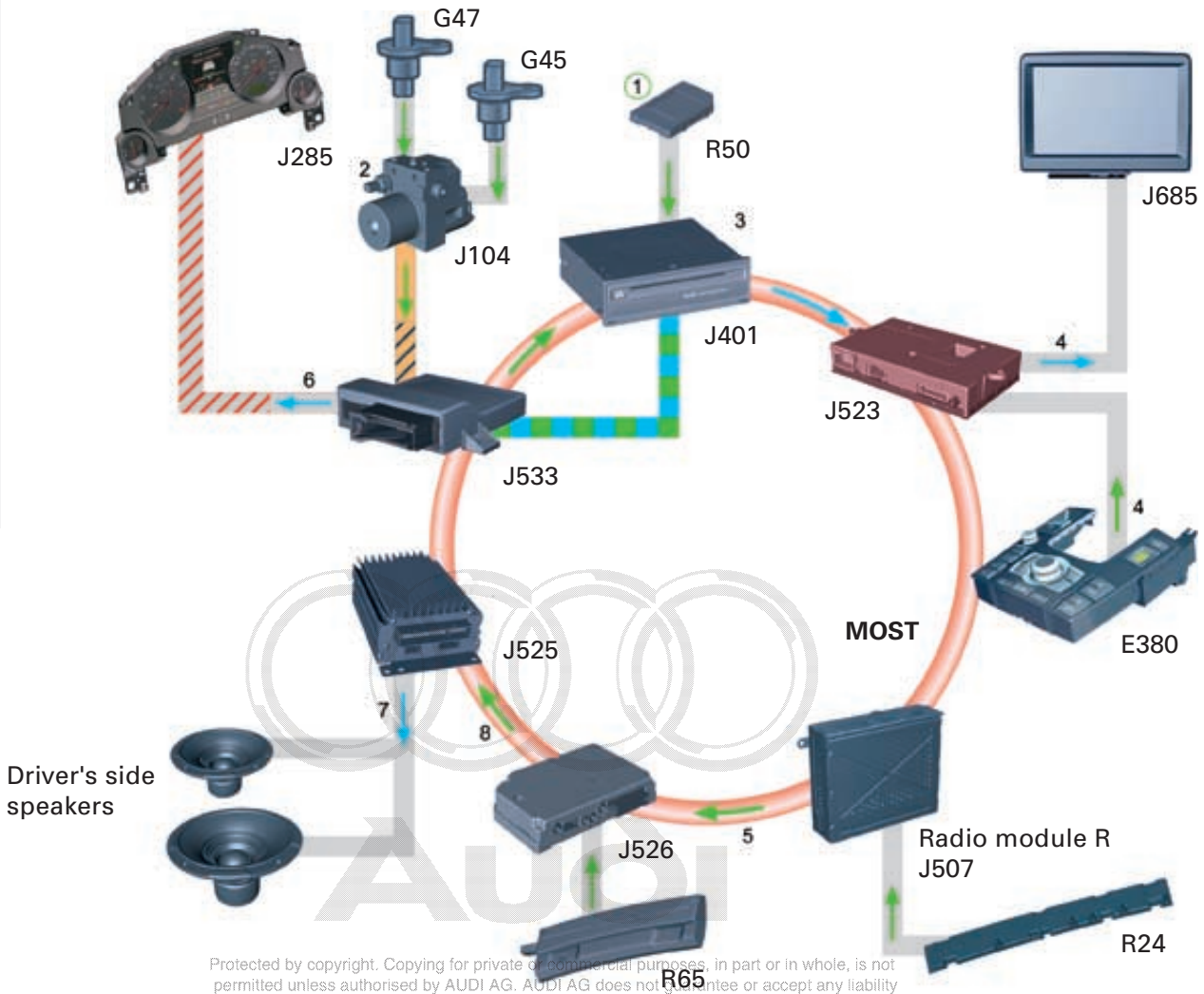

SSP293_049

Signals for calculating current vehicle location

1 Satellite navigation

Design and operation of the GPS navigation aerial R50 correspond to those of the GPS aerial installed in the Audi A4 '01.

The aerial is located at the top of the rear window.

Dead reckoning

Front wheel travel pulses

- The navigation system in the Audi A8 '03 uses the number of front wheel travel pulses for dead reckoning. The number of front wheel travel pulses is calculated by the ABS with EDL control unit J104 on the basis of the front left G47 and front right G45 speed sensor signals and transmitted to the drive system CAN. The data bus diagnostic interface J533 reads the information in the drive system CAN and transmits it by way of the MOST bus to the navigation system control unit J401.

Yaw rate

- 3 As with familiar navigation systems, a yaw rate sensor is integrated into the navigation system control unit J401.

Front information display and operating unit control unit J523

- 4 As infotainment system master, the control unit J523 controls
- Destination input and selection with the aid of the MMI and dialog system
 - Presentation of navigation displays in the front information display unit and dash panel insert display
 - Reproduction of voice messages via speakers

Language input control unit J507

- 5 The language input control unit J507 transmits the voice inputs for destination entry and navigation activation converted into digital information to the front information display and operating unit control unit J523 by way of the MOST bus.

J523 accepts the entries and controls the navigation system accordingly.

- 6 By way of the MOST bus, the navigation system control unit J401 transmits the information

- For presentation of navigation displays to the front information display and operating unit control unit J523. This makes use of the information to set up the presentations which are then shown on the two displays. The map display images are an exception to this. These images are set up by the navigation system control unit.
- For reproduction of voice messages to the digital sound package control unit J525.

- 7 The navigation system control unit J401 transmits the audio data in a synchronous MOST bus transmission channel.

As instructed by the front information display and operating unit control unit J523, the digital sound package control unit J525 reduces the volume of the entertainment functions and reproduces the audio data by way of the speakers on the driver's side.

- 8 The telephone/telematics control unit J526 and the radio module R transmit the traffic news data by way of the MOST bus to the navigation system control unit J401.

This makes allowance for the reported traffic hold-ups in the dynamic navigation process.

On the navigation map display, traffic hold-ups take the form of graphic symbols. A new feature is that the traffic hold-up symbols relating to the opposite direction and thus not affecting the navigation process are shown in grey.

In addition, users can have traffic information displayed in text form by way of the multimedia interface after pressing the INFO button.



Navigation

Diagnosis

Address word 37 - Navigation

Fault memory entries

The following situations

- Incorrect loading and ejection of CD/DVD-ROM
- Exceeding of max. perm. temperature of CD/DVD drive
- Access problems with navigation CD/DVD data
- Implausible yaw rate sensor signal
- Sticking of EJECT button
- MOST bus open circuit or increased attenuation

result in fault memory entries in the navigation system control unit J401.

Adaption

In addition to adaption of the familiar navigation systems, the adaption function permits

- Self-testing of processor unit
- Self-testing of CD/DVD drive
- Ejection of CD/DVD

Measured value blocks

As with the previously described systems, the MOST communication statuses are displayed in the measured value blocks.

New measured value blocks as compared to familiar navigation systems are

- Temperature of CD/DVD drive
- Direction of travel
- Status of satellite reception
- Status of CD/DVD drive
- Status of EJECT button
- Current longitude and latitude based on GPS signal
- GPS data



Audi

Protected by copyright. Copying for private or commercial purposes, in part or in whole, is not permitted unless authorised by AUDI AG. AUDI AG does not guarantee or accept any liability with respect to the correctness of information in this document. Copyright by AUDI AG.

erWin 

Telephone/Telematics

Introduction

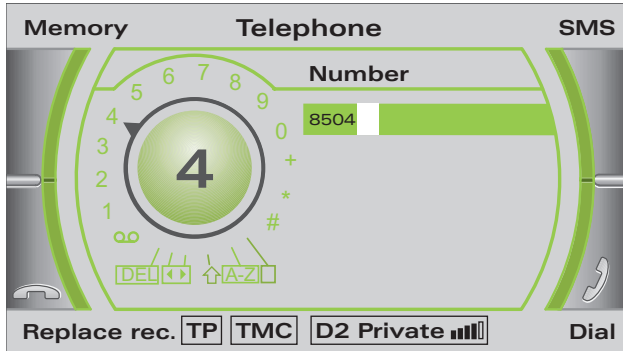

SSP293_051

Protected by copyright. Copying for private or commercial purposes, in part or in whole, is not permitted unless authorised by AUDI AG. AUDI AG does not guarantee or accept any liability with respect to the correctness of information in this document. Copyright by AUDI AG.

In addition to the multimedia interface, the Audi A8 '03 has been fitted with a completely new communications platform for telephone and telematics applications.

The communications platform features dual-band capability. In other words, the telephone and data link can be established by way of the carrier frequencies 900 (D-network) and 1800 (E-network) MHz.

The MMI and hands-free unit are used for control and operation of the communications platform. A cordless handset is also available as an option.

Bluetooth™ technology is employed for the exchange of data between handset and communications platform.

Information on Bluetooth™ technology can be found in SSP 286 – New Data Bus Systems LIN, MOST, Bluetooth™.

In addition, the communications platform enables users to receive SMS messages.



Telephone/Telematics

Address book

The communications platform in the Audi A8 '03 provides users with an extended address book function.

The personalised address book is stored in the front display and operating unit control unit J523.

The data structure takes the form of lists of electronic entries (address cards).

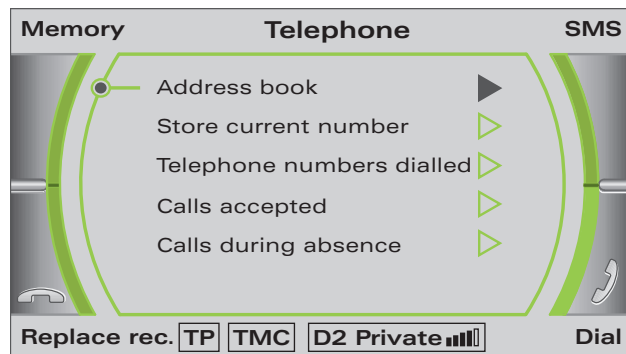

SSP293_050

Each address card contains data fields for storage of

1 Data on person concerned

- Surname, first name
- Title
- Profession
- Position in company
- Company, division

2 Corresponding data required for communication

- Private and business telephone numbers
- Private and business telefax numbers
- Email address
- Web address

3 Address data

- Private address
- Business address

4 Destination address for navigation

- Private and business addresses are used as the basis for navigation destination address
- Geographical location of address (longitude and latitude)

The address book data are displayed as required for the desired function.

In other words, the display unit shows

- Name
- Data on person concerned
- Navigation address data

in the "Navigation address book" menu.

In the telephone function, the display unit shows the telephone numbers of the person concerned instead of the address data.

Protected by copyright. Copying or publishing or otherwise disseminating this document is prohibited unless authorised by AUDI AG. AUDI AG does not assume any liability with respect to the correctness of information in this document. Copyright by AUDI AG.



Input/output signals

The telephone/telematics control unit receives the following input signals:

- Card reader for telephone R115
 - Navigation system aerial
 - Microphone 3 in microphone unit in roof module R164
 - Telematics operating unit E264
 - Airbag control unit J234
 - ABS with EDL control unit J104
 - Telephone handset R37
- Via bidirectional wire:
- Aerial for Bluetooth™ R152
 - Telephone bracket R126
 - Telephone aerial R65
 - Additional aerial for telematics R90
 - Data bus diagnostic interface J533 (ring fault diagnosis)



The telephone/telematics control unit actuates the following:

- Card reader for telephone R115
 - Telematics operating unit E264
 - Additional loudspeaker for telematics R91
 - Telephone handset R37
- Via bidirectional wire:
- Aerial for Bluetooth™ R152
 - Telephone bracket R126
 - Telephone aerial R65
 - Additional aerial for telematics R90
 - Data bus diagnostic interface J533 (ring fault diagnosis)

Protected by copyright. All rights reserved. No part of this publication may be reproduced, stored in a retrieval system, or transmitted, in any form or by any means, electronic, mechanical, photocopying, recording, or by any information storage and retrieval system, without the prior written permission of Audi AG. Audi AG does not guarantee or accept any liability with respect to the content of this document. Copyright by Audi AG.



Telephone/Telematics

Card reader for telephone R115

All telephone functions are fully integrated into the MMI system. A telephone card reader is provided in the centre console to facilitate replacement of the SIM card.

This means that the telephone is operated with the aid of the MMI and microphone/loudspeaker system only.

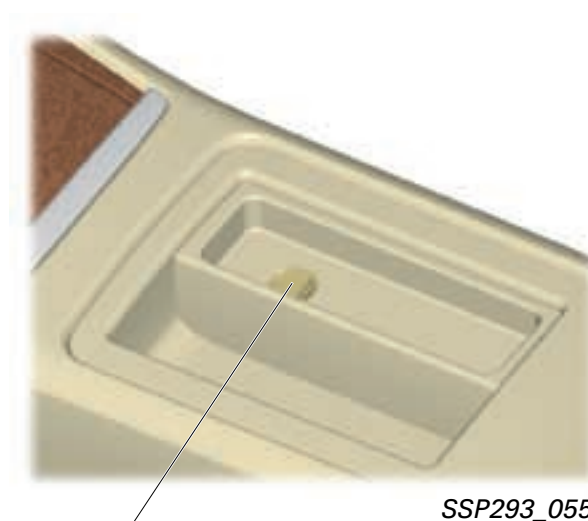

SIM card reader

SSP293_055

Emergency battery, telematics A16 and SIM card in telephone/telematics control unit J526

As with earlier telematics systems, the emergency battery A16 and telematics SIM card are installed in the telephone/telematics control unit J526.

Further information can be found in SSP 236 – Audi telematics®.



The additional aerial for telematics is only active in the event of failure of the telephone aerial R65.

In the event of sound system failure only, telephone audio reproduction is provided in emergency operation by way of the additional loudspeaker for telematics R91.

Diagnosis

Address word 77 - Telephone
75 - Emergency call module

Fault memory entries

The self-diagnosis function of the telephone/telematics control unit monitors

- Power supply
- Communication via MOST bus
- Communication with card reader for telephone R115
- Telematics operating unit E264
- Additional loudspeaker for telematics R91
- Wiring from airbag control unit J234 for transmission of crash signal
- Microphone 3 in microphone unit in roof module R164
- Telephone aerial R65
- Additional aerial for telematics R90
- Status of emergency battery for telematics A16
- GPS navigation aerial R50
- Bluetooth™ aerial in telephone bracket R126
- Wiring from ABS with EDL control unit J104 for transmission of wheel speeds
- Communication with internal telematics SIM card

with the corresponding fault memory entries being made.

Protected by copyright. Copying for private or commercial purposes, in part or in whole, is not permitted unless authorised by AUDI AG. AUDI AG does not guarantee or accept any liability with respect to the accuracy of information published herein. Copyright by AUDI AG.

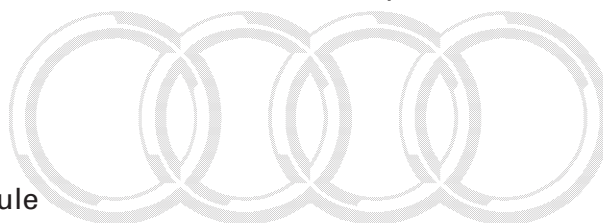

Audi

Measured value blocks

The measured value blocks display

- Statuses of vehicle battery and emergency battery
- MOST address (position in ring)
- MOST identifier (type of unit)
- Status of diagnosis wire
- Statuses and numbers of users as well as of telematics SIM card
- Status of mobile phone link
- Status of telephone aerial and additional aerial for telematics
- Number of GPS satellites received
- Number and designations of connected Bluetooth™ units
- Status of microphone 3 in microphone unit in roof module
- Speed of rear wheels
- Status of GPS navigation aerial

Control element test

The control element test permits checking of

- Additional loudspeaker for telematics R91
- Lamps in telematics operating unit
- Telephone aerial/additional aerial switching
- GPS navigation aerial
- Bluetooth™ link with handset

Encoding

The vehicle version must be indicated in the encoding.

Adaption

The adaption function is used to

- Activate service mode
- Deactivate telematics function
- Deactivate Bluetooth™ function
- Reset timer on replacing emergency battery
- Set telephone continued operation time.

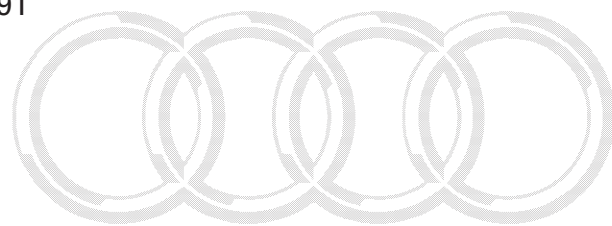

Audi

Protected by copyright. Copying for private or commercial purposes, in part or in whole, is not permitted unless authorised by AUDI AG. AUDI AG does not guarantee or accept any liability with respect to the correctness of information in this document. Copyright by AUDI AG.

erWin 

Telephone/Telematics

Front information display and operating unit control unit J523

As master control unit, the front information display and operating unit control unit J523 is responsible for

- Telephone and telematics system display via MMI
- Control of address list in dash panel insert display
- Activation of telephone via multi-function steering wheel
- Control signals for hands-free unit audio transmission
- Storage and selection of entries in address book

with transmission of data in the MOST bus to the telephone/telematics control unit J526.

Digital sound package control unit J525

The digital sound package control unit reproduces the audio signals for the hands-free unit and call tones via the loudspeakers.

In addition it transmits the audio signals of microphones 1 and 2 in the microphone unit in the roof module to the MOST bus.

Language input control unit J507

Control unit J507 conditions the digital audio data of the microphones of the digital sound package control unit J525 and the telephone/telematics control unit J526 and returns the conditioned signals to the MOST bus. These signals are reproduced by way of the telephone hands-free unit for the exchange of commands with the driver.

Navigation system control unit J401

The telephone/telematics control unit J526 receives data on traffic hold-ups via SMS (messages from telematics service provider) by way of the familiar telematics function.

This data is transmitted by the telephone/telematics control unit on the MOST bus to the navigation system control unit J401, where it is used for dynamic navigation purposes.

Data bus diagnostic interface J533

In the telephone/telematics system, the data bus diagnostic interface is responsible for

- Transmission of data for address book display in dash panel insert to dash panel insert CAN
- Transmission of diagnosis data to diagnosis CAN



Protected by copyright. Copying for private or commercial purposes, in part or in whole, is not permitted unless authorised by AUDI AG. AUDI AG does not guarantee or accept any liability with respect to the correctness of information in this document. Copyright by AUDI AG.



MOST bus links

The illustration shows the MOST bus applications required for operation of the telephone/telematics system.

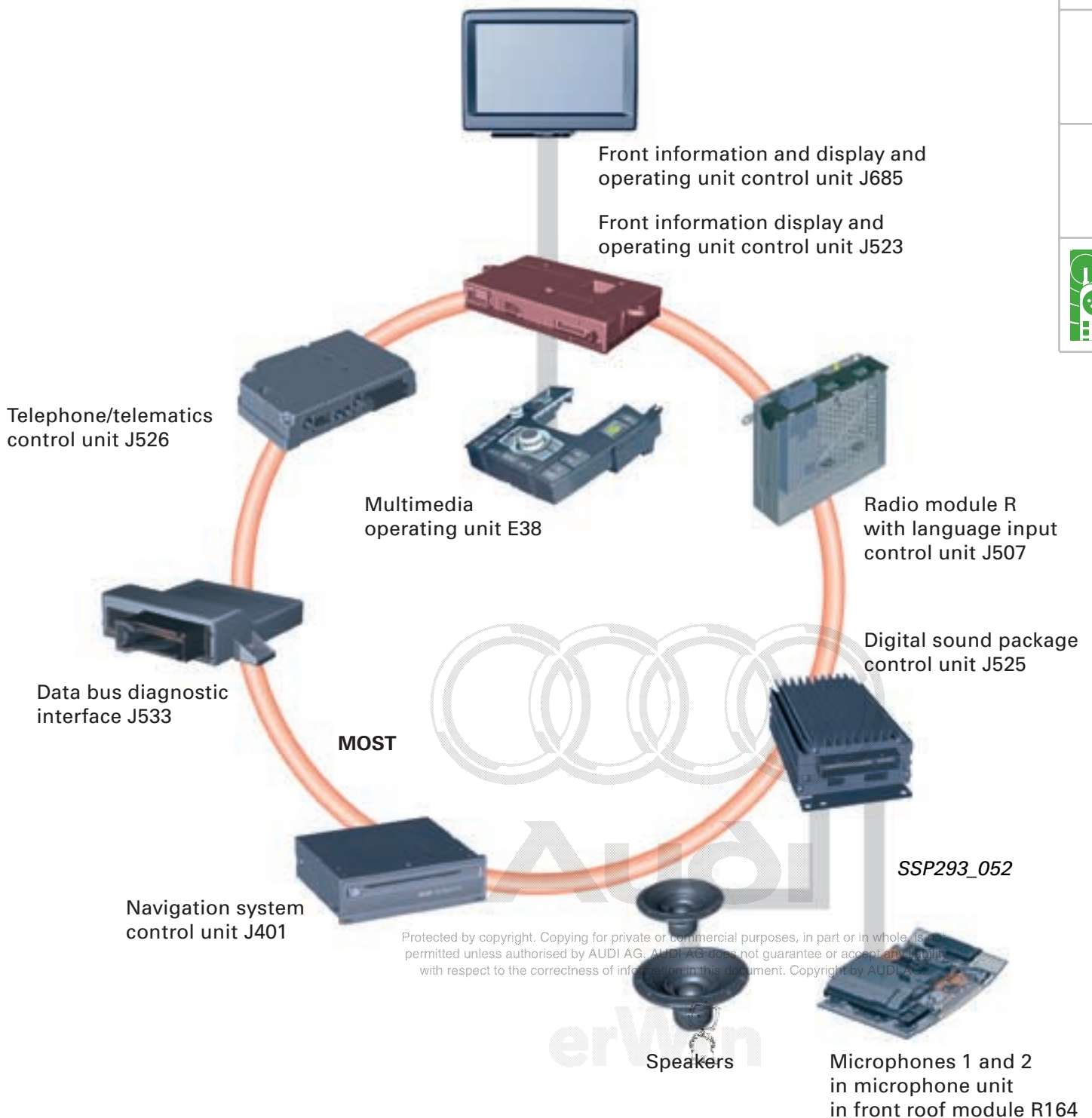

Telephone/Telematics

Cordless telephone handset

The handset is available as an optional extra.

The handset holder is located beneath the front centre armrest.

As Bluetooth™ technology is used for data transmission, the moulded holder only has three integrated contacts for charging the battery in the handset and for terminal 15.

To ensure an optimum handset charge, it should always be replaced in its holder.



SSP293_053

SIM card reader Handset power supply



Establishing Bluetooth™ link with handset

Activation of the handset automatically establishes the Bluetooth™ link.

If the link is not established automatically on activating the handset, the connection process must be repeated.

Handset adaption must be performed if handset/telephone assignment no longer exists on account of component replacement or user error.

Refer to the current manual in the vehicle for this purpose.

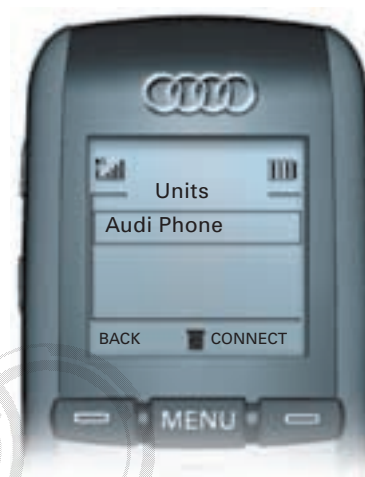

SSP293_059



Detailed information on Bluetooth™ technology can be found in SSP 286 "New Data Bus Systems - LIN, MOST, Bluetooth™ and the multimedia interface operating instructions".

Information for private or commercial purposes, in part or in whole, is not permitted unless authorised by AUDI AG. AUDI AG does not guarantee or accept any liability for the correctness of information in this document. Copyright by AUDI AG.



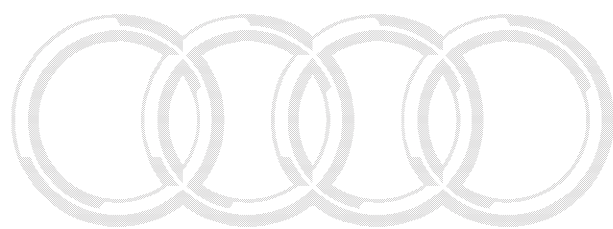

Audi

Protected by copyright. Copying for private or commercial purposes, in part or in whole, is not permitted unless authorised by AUDI AG. AUDI AG does not guarantee or accept any liability with respect to the correctness of information in this document. Copyright by AUDI AG.

erWin 



Audi

Protected by copyright. Copying for private or commercial purposes, in part or in whole, is not permitted unless authorised by AUDI AG. AUDI AG does not guarantee or accept any liability with respect to the correctness of information in this document. Copyright by AUDI AG.



All rights reserved. Subject to technical modification.
Copyright* 2002 AUDI AG, Ingolstadt
Department I/VK-35
D-85045 Ingolstadt
Fax 0841/89-36367
000.2811.13.20
Technical status as at 07/02
Printed in Germany